

High Feed Mill Double

HFMD

KORLOY
TECH-NEWS



- Available for economical and highly efficient machining with implementation of double sided 4 corner inserts and increase in the number of teeth per cutter diameter
- Available for high speed/high feed machining with high helix edge design and excellent clamping stability

High Feed Milling Tool with 4 Corners for Small Diameter

HFMD

With the development of the end-user market, the current cutting tool industry has challenges including:

First, discovering highly effective machining technologies that can improve productivity and reduce production costs within limited time and budget. Second, to find a tool/solution that can easily machine hard-to-cut materials which are becoming more widely used in numerous industries (mold, aerospace, and etc) in pursuit of durability and lighter weight.

KORLOY recommends a new high feed tool, HFMD, which can easily resolve above two challenges.

HFMD insert is a double sided 4 corner insert which is economical and enhances machining productivity by implementing more flutes per diameter. In addition,

HFMD has achieved high speed/high feed machining by applying high rake angle and helix design on its edge. These two features have significantly reduced cutting resistance compared to competitors' tools or even against positive-type inserts.

Furthermore, HFMD provides excellent clamping stability by applying concave clamping system on the side, wider bottom face at the clamping area, and bigger sized screws. These will help minimize noise and vibration, prevent damage of insert with stable machining in high feed machining, and improve the surface finish of the workpiece.

As we can see in these advantages, KORLOY's HFMD is the next-generation high speed/high feed machining solution, one step ahead in the high-efficiency machining trend.



Highly efficient and economical insert

- Double-sided 4 corners

Superior clamping stability

- Prevents insert chipping and damage by minimizing vibrations
- Improved surface finish of workpieces

Realization of high speed/high feed

- High speed machining by applying high rake angle, and helix cutting edge
- Available for high feed machining with the increase in the number of teeth per cutter diameter

Optimized holder design

- Excellent chip evacuation in slotting or deep shouldering with minimized interference with side walls

Application Range

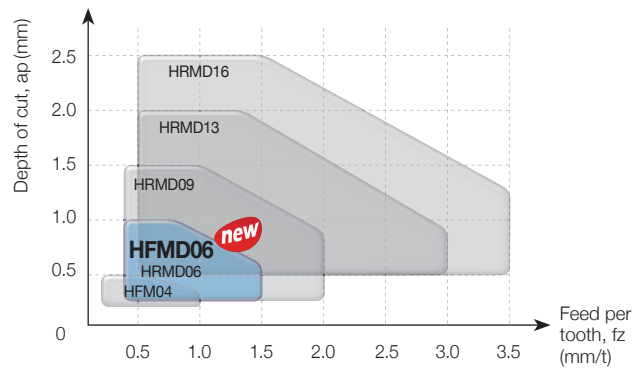
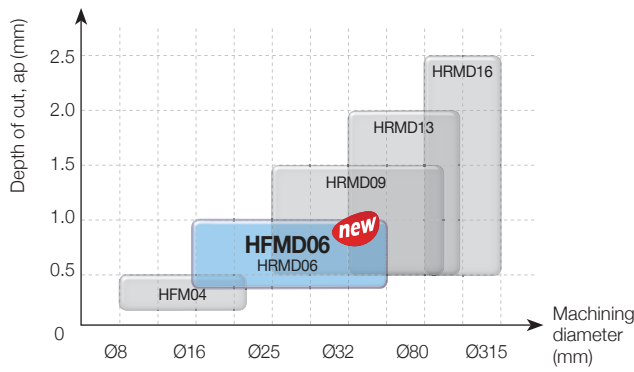

Code System

【Shank type】

HFMD	S	025	R	-	4	C	25	-	180	-	LN06
HFMD	Type	Machining diameter 025: Ø25 mm	Oil hole & Hand		No. of tooth 4: 4 teeth	Shank type	Shank diameter 25: Ø25 mm		Overall length 180: 180 mm		Available inserts LN06: LNMX06
	S: Shank		R: With oil hole, Right-handed NR: Without oil hole, Right-handed			W: Weldon C: Cylinder					

【Cutter type】

HFMD	C	M	040	R	-	22	-	7	-	LN06
HFMD	Type	Arbor type	Machining diameter	Oil hole & Hand		Internal diameter		No. of tooth		Available inserts
	C: Cutter	M: Metric A: Inch None: Asia	040: Ø40 mm	R: With oil hole, Right-handed NR: Without oil hole, Right-handed		22: Ø22 mm		7: 7 teeth		LN06: LNMX06

【Modular type】

HFMD	M	025	R	-	4	-	M12	-	LN06
HFMD	Type	Machining diameter	Oil hole & Hand		No. of tooth		M Dimensions		Available inserts
	M: Modular	025: Ø25 mm	R: With oil hole, Right-handed NR: Without oil hole, Right-handed		4: 4 teeth				LN06: LNMX06

Features

- Economical 4-corner double sided insert
- Increased productivity due to thinner and elongated shape of the insert which makes fine pitch available
- Insert designed for low cutting resistance with high rake angle and helix angle which reduces cutting load
- Inhibiting chipping and breakage due to concave clamping system and stronger screw





Insert designed for low cutting resistance

- High rake angle and helix angle minimize cutting resistance compared to competitors' products and positive type of inserts

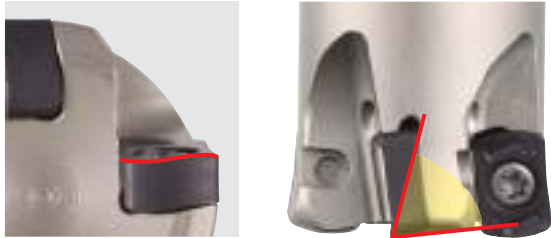

[HFMD] [Competitor]

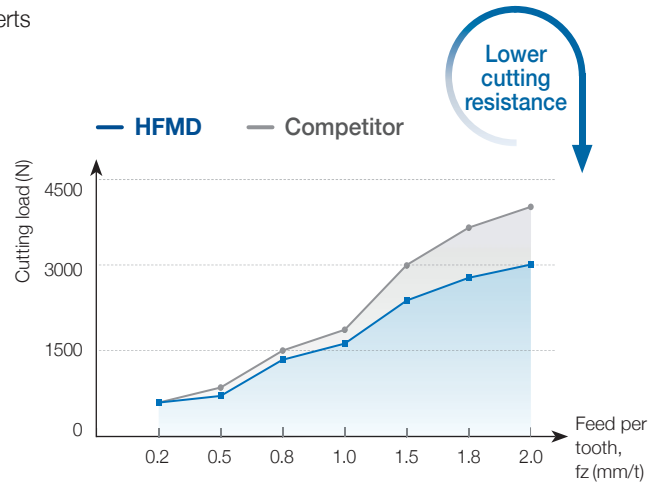

- ▶ Able to check reduced cutting resistance with bright colored chips

Insert with strong clamping force



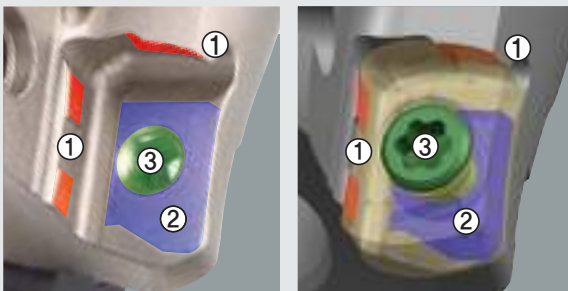

- ① Concave clamping system
- ② Wider bottom face clamping area
- ③ Applied a bigger size of screw

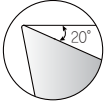

[HFMD] [Competitor]

- ▶ Enhanced HFMD clamping force ensures stable tool life in high feed machining.
- ▶ Competitor's unstable clamping causes fracture.

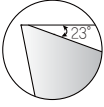
Application and Features of Chip Breakers

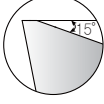
Chip breakers		Cutting-edge	Application	Features
ML			For hard-to-cut materials For Ti & inconel	Ensures superior machining quality by applying a low cutting resistance chip breaker and high-strength cutting edge design suitable for machining hard-to-cut materials
MF			For light cutting	Suitable for light cutting with a low cutting resistance chip breaker design
MM			For multi-purpose	Available for most cutting area with its exclusive design suitable for general high feed machining

Recommended Cutting Conditions

※ Recommended chip breaker: ● 1st ○ 2nd



ISO	Workpiece					Grade	Cutting conditions				Available chip breaker				
	Workpiece materials	ISO (DIN)*	AISI	KS	HB (HRC)		vc (m/min)	fz (mm/t)	ap (mm)	ae	ML	MF	MM		
P	Mild steel	C25 (CK22)*	1020	SM20C	120-180	PC5400 (PC5300)	100-220	0.3-1.2	0.2-1.0	0.7D-0.1D	○	●	-		
	Carbon steel	C45/C45E4 (C45/CK45)*	1042 1045	SM45C	200	PC5400 (PC5300)	100-200	0.3-1.2	0.2-1.0	0.7D-0.1D	○	●	-		
	Alloy steel	41CrMo4	4140	SCM440	270(28)	PC3700 (PC5300)	100-200	0.3-1.2	0.2-1.0	0.7D-0.1D	○	●	-		
	Pre-hardened steel	-	(1,2738)*	P20 (Improved)	KP4M	300(32)	PC3700 (PC5300)	100-180	0.3-1.0	0.2-0.8	0.7D-0.1D	-	●	○	
		-	-	P21 (Improved)	NIMAX	370(40)	PC3700 (PC5300)	100-180	0.3-1.0	0.2-0.8	0.7D-0.1D	-	●	○	
		-	-	P21 (Improved)	CENA1	370(40)	PC3700 (PC5300)	100-180	0.3-1.0	0.2-0.8	0.7D-0.1D	-	●	○	
		-	-	P21 (Improved)	NAK80	400(43)	PC3700 (PC5300)	100-180	0.3-1.0	0.2-0.8	0.7D-0.1D	-	●	○	
-	(X30Cr13)*	420	STAVAX	510(52)	PC3700 (PC2510)	80-150	0.3-0.7	0.2-0.8	0.7D-0.1D	-	●	○			
Alloy tool steel	-	(X165CrMo12-1 X40CrMoV5-1)*	D2 H13	STD11 STD61	- (40-50)	PC2510 (PC3700)	80-130	0.3-0.65	0.2-0.6	0.7D-0.1D	-	○	●		
M	Stainless steel	-	(X5CrNiMo17-12-2)*	316	STS316	Under 270	PC5400 (UNC840)	90-180	0.3-0.8	0.2-0.8	0.7D-0.1D	●	○	-	
K	Grey cast iron, Ductile cast iron	450-10 (GGG40.3)*	65-45-12	GCD450	Tensile Strength Over 450Mpa	PC5300 (PC5400)	130-220	0.3-0.9	0.2-1.0	0.7D-0.1D	-	●	○		
S	HRSA	Fe series	-	(WS 2.4662)*	N09901	Incoroy901	- (25-35)	UNC840 (PC5300)	30-100	0.3-0.6	0.2-0.6	0.4D-0.7D	●	○	-
		Ni or Co series	-	(WS 2.4668)*	N07718	Inconel718	- (35-45)	UNC840 (PC5300)	30-45	0.3-0.7	0.2-0.6	0.4D-0.7D	○	●	-
	Titanium	-	(TiAl6V4)*	R56400	Ti-6AL-4V	- (40-45)	UNC840 (PC5300)	30-50	0.3-1.0	0.2-0.6	0.7D-0.1D	●	○	-	

High Feed Tool Selection Guide

HFMD 06 new

- To increase productivity
- To machine workpiece with more edges



HFM 04

- To machine smaller diameter
- Min. Ø8 mm machining

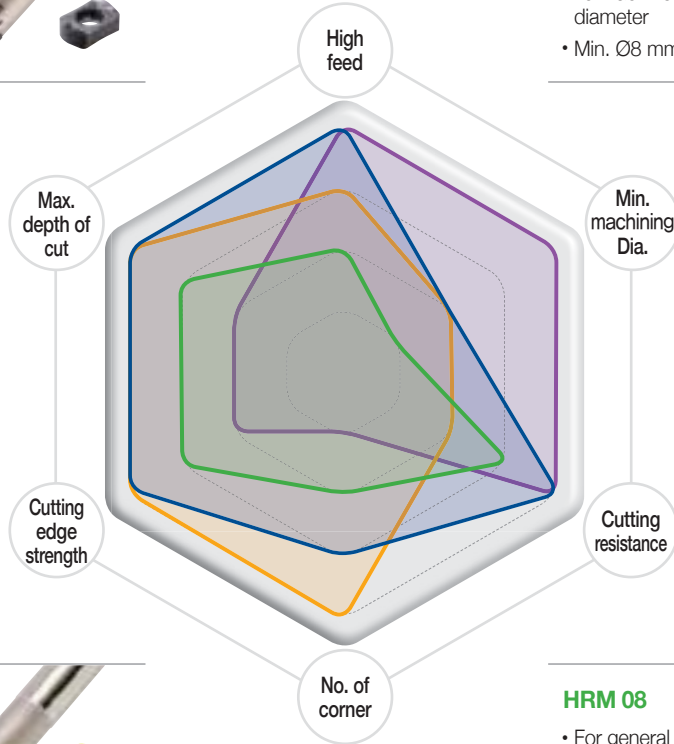

HRMD 06

- To focus on economical feasibility
- Double-sided 6 corners machining



HRM 08

- For general machining
- Single-sided 3 corners machining



Product name	High feed	Min. machining Dia.	Cutting resistance	No. of corner	Cutting edge strength	Max. depth of cut
HFMD 06 <small>new</small>	★★★★	★★	★★★★	★★★	★★★★	★★★★
HFM 04	★★★★	★★★★	★★★★	★	★★	★★
HRM 08	★★	★	★★★	★★	★★★	★★★
HRMD 06	★★★	★★	★★	★★★★	★★★★	★★★★

Grade Selection Guide

Workpiece		Machining type	Grade	Recommended cutting speed (m/min)	ISO	Application range
P	Steel	Continuous cutting	PC2510 new	180 (140-220)	P10	PC2510 new
		Continuous cutting	PC3700 new	235 (180-290)	P20	
		Interrupted cutting	PC5300	195 (150-240)	P30	PC3700 new PC5300
		Interrupted cutting	PC5400	145 (80-210)	P40	PC3700 new PC5300 PC5400 new
M	Stainless steel	Continuous cutting	PC5300	130 (100-160)	M20	PC5300
		Interrupted cutting	PC5400	110 (80-140)	M30 M40	PC5300 PC5400 new
K	Cast iron	Continuous cutting	PC5300	145 (110-180)	K20	PC5300
		Interrupted cutting	PC5400	125 (85-160)	K30	PC5300 PC5400 new
S	HRSA	Continuous cutting	PC5300	55 (40-70)	S10 S20	PC5300
		Interrupted cutting	UNC840 new	60 (40-80)	S30 S40	UNC840 new

Grade Selection

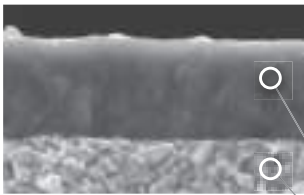

PC5300

Ultra fine highly tough substrate & high temperature and high hardness coating technology

- Superior wear resistance, chipping resistance with high temperature, high hardness, and oxidation resistance coating technology
- Superior chipping resistance and machining stability with ultra fine highly tough substrate



PC3700 **new**

General steel milling substrate & PVD coating technology

- Increased wear resistance, welding resistance, wear resistance with high hardness, lubricative multi-layer coating technology
- Attained general machinability by applying wear and breakage resistant materials optimized for steel milling machining

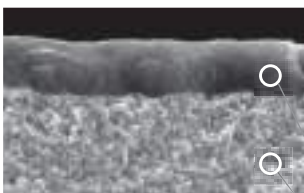

PC2510 **new**

Exclusive substrate for high hardness workpiece and coating surface treatment technology

- Improved welding resistance, chipping resistance, machining stability by adding surface treatment technology to high hardness coating
- Wear resistance, chipping resistance, and machining stability with high hardness substrate

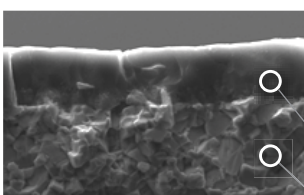

UNC840 **new**

Exclusive substrate for Hard-to-cut materials & CVD coating technology

- 40 GPa coating hardness, 0.3 μm coating surface finish, improved heat resistance, chipping resistance, and welding resistance
- Applying specialized substrate strengthens the welding resistance and chipping resistance during machining of hard-to-cut materials

Cutting Performance

Carbon steel (C45, HB200)

- **Workpiece** Steel rectangular tube (300×200×100)
- **Cutting conditions** vc (m/min) = 200, fz (mm/t) = 1.2, ap (mm) = 0.8, ae (mm) = 20, dry
- **Tool** **Insert** LNMX060310R-MF **Holder** HFMSD032R-5C32-200-LN06 (Ø32, 5T)

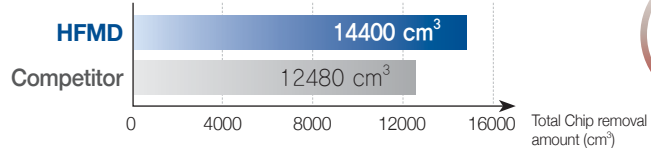
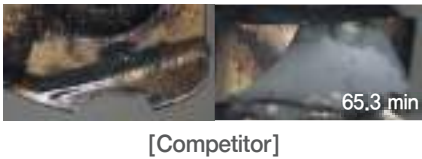

15% Improved

- Chip removal rate Q (cm³/min): 191.0
- Cutting time (min): 75.4

Alloy steel (41CrMo4, HB250)

- **Workpiece** Steel rectangular tube (300×200×100)
- **Cutting conditions** vc (m/min) = 180, fz (mm/t) = 1.0, ap (mm) = 0.8, ae (mm) = 20, dry
- **Tool** **Insert** LNMX060310R-MF **Holder** HFMSD032R-5C32-200-LN06 (Ø32, 5T)

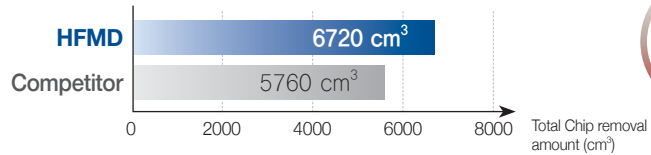
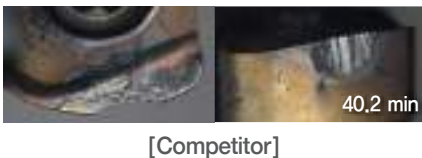

17% Improved

- Chip removal rate Q (cm³/min): 143.2
- Cutting time (min): 46.9

(*: DIN)

Pre-hardened steel (1,2738*, HRC30)

- **Workpiece** Steel rectangular tube (300×200×100)
- **Cutting conditions** vc (m/min) = 160, fz (mm/t) = 1.2, ap (mm) = 0.8, ae (mm) = 20, dry
- **Tool** **Insert** LNMX060310R-MF **Holder** HFMSD032R-5C32-200-LN06 (Ø32, 5T)

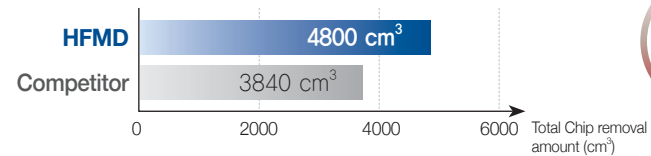
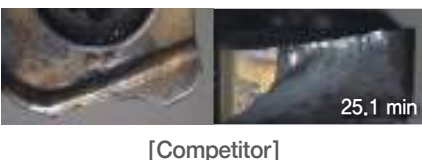

25% Improved

- Chip removal rate Q (cm³/min): 152.8
- Cutting time (min): 31.4

Ramping and Helical Cutting

Ramping

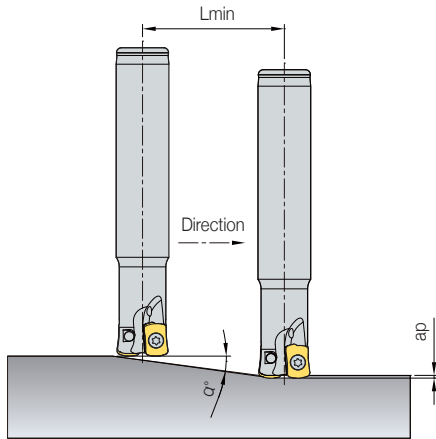

$$L_{min} = \frac{ap}{\tan \alpha^\circ} \text{ (mm)}$$

- ※ Lmin : Min. inclination cutting length
- α° : Max. rake angle for ramping
- ap : Depth of cut

Helical cutting

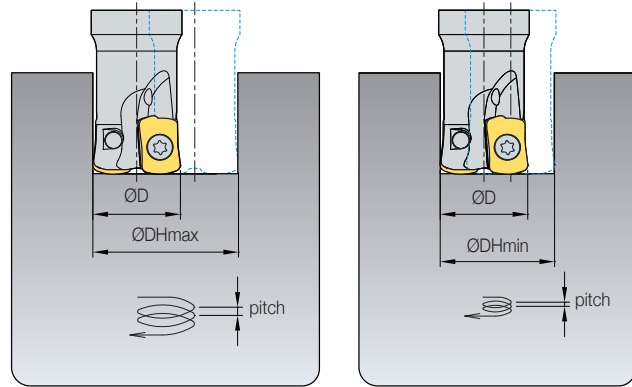

- ØD = Tool dia. (mm)
- Ød = Tool path. (mm) = ØDHmin, max - ØD

(mm)

Designation	Tool dia. ØD	ap	Ramping		Blind hole helical cutting				Through hole helical cutting	
			Max. rake angle α°	Lmin	Max. machining dia. DHmax	Max. pitch	Min. machining dia. ØDHmin	Max. pitch	Min. machining dia. ØDHmin	Max. pitch
HFMS016	16	0.7	3.0	13	30	0.7	22	0.7	21	0.7
HFMS017	17	1.0	2.3	25	32	1.0	24	1.0	22	1.0
HFMS018	18	1.0	2.1	27	34	1.0	26	1.0	24	1.0
HFMS019	19	1.0	1.9	30	36	1.0	28	1.0	26	1.0
HFMS020	20	1.0	1.5	37	38	1.0	30	1.0	28	1.0
HFMS021	21	1.0	1.5	39	40	1.0	32	1.0	30	1.0
HFMS025	25	1.0	1.4	40	48	1.0	40	1.0	38	1.0
HFMS026	26	1.0	1.4	42	50	1.0	42	1.0	40	1.0
HFMS030	30	1.0	1.1	51	58	1.0	50	1.0	48	1.0
HFMS032	32	1.0	1.0	55	62	1.0	54	1.0	52	1.0
HFMS033	33	1.0	1.0	57	64	1.0	56	1.0	54	1.0
HFMS035	35	1.0	0.9	61	68	1.0	60	1.0	58	1.0
HFMS040	40	1.0	0.8	71	78	1.0	70	1.0	68	1.0
HFMD042	42	1.0	0.8	76	82	1.0	74	1.0	72	1.0
HFMD050	50	1.0	0.6	92	98	1.0	90	1.0	88	1.0
HFMD052	52	1.0	0.6	96	102	1.0	94	1.0	92	1.0
HFMD063	63	1.0	0.5	119	124	1.0	116	1.0	114	1.0
HFMD066	66	1.0	0.5	126	130	1.0	122	1.0	120	1.0

- Adjust feed [vf (mm/min)] to under 70% of recommended cutting condition when ramping & helical cutting
- In helical ramping, max. cutting depth (dmax) per 1 helical revolution of cutter should not exceed max. cutting depth (ap) as per insert size
- In ramping, max. cutting depth per 1 ramping process of cutter should not exceed max. depth of cut as per used insert size

Caution for Corner R Programming

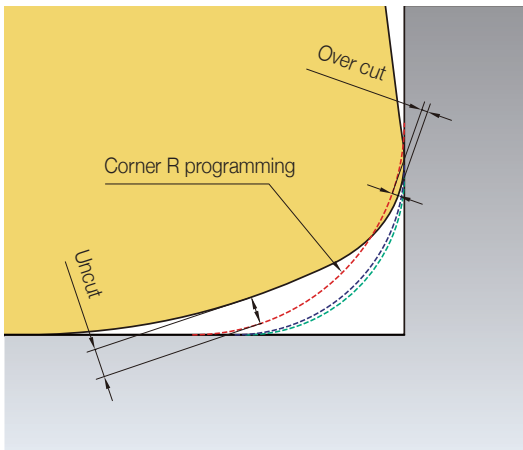

----- R2.0 - - - - R1.6 - · - · R1.5

(mm)

Insert	Corner R programming	Cutting conditions		Over cut	Uncut
		Nose R	Max. ap ap		
LNMX060310R-ML LNMX060310R-MF LNMX060310R-MM	R1.5	1.0	1.0	0	0.41
	R1.6 (Standard)			0	0.38
	R2.0			0.057	0.27

- During usage of CNC program, over cut & uncut would be occurred on the corner processing site if entering the correct program corner R value for each insert
- To prevent overcut, you will need to complete a CNC program considering the above overcut

Insert

(mm)

Designation	Application	Coated					Dimensions				Configuration
		UNC840	PC5400	PC5300	PC3700	PC2510	l	d	t	r	
LNMX060310R	ML For hard-to-cut materials Ti & inconel	●	●	●	-	-	10	6.8	3.6	1	
	MF For light cutting	●	●	●	●	●	10	6.8	3.6	1	
	MM For general cutting	-	●	●	●	●	10	6.8	3.6	1	

● : Stock item

Parts

Specification	Screw	Wrench
Ø16~Ø66	FTNA0306	TW09S

HFMD5-LN06

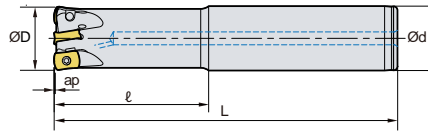

• AR: -9°
• RR: 10°-15°

(mm)

Designation	Stock		ØD	Ød	ℓ	L	ap	
HFMD5 016R-2C16-100-LN06	●	2	16	16	30	100	0.7	0.13
016R-2C16-150-LN06	●	2	16	16	50	150	0.7	0.19
017R-2C16-100-LN06	●	2	17	16	30	100	1.0	0.13
017R-2C16-150-LN06	●	2	17	16	40	150	1.0	0.20
017R-2C16-200-LN06		2	17	16	40	200	1.0	0.27
018R-2C16-100-LN06		2	18	16	40	100	1.0	0.14
018R-2C16-160-LN06		2	18	16	40	160	1.0	0.18
018R-2C16-200-LN06		2	18	16	40	200	1.0	0.28
019R-2C16-100-LN06		2	19	16	40	100	1.0	0.15
019R-2C16-160-LN06		2	19	16	40	160	1.0	0.19
019R-2C16-200-LN06		2	19	16	40	200	1.0	0.29
020R-3C20-100-LN06		3	20	20	40	100	1.0	0.20
020R-3C20-130-LN06	●	3	20	20	50	130	1.0	0.26
020R-3C20-160-LN06		3	20	20	80	160	1.0	0.31
020R-3C20-200-LN06	●	3	20	20	120	200	1.0	0.40

● : Stock item

Available Inserts



LNMX-ML



LNMX-MF



LNMX-MM

Designation	Coated				
	UNC840	PC5400	PC5300	PC3700	PC2510
LNMX 060310R-ML	●	●	●	-	-
060310R-MF	●	●	●	●	●
060310R-MM	-	●	●	●	●

Parts

Specification	Screw 	Wrench
Ø16~Ø40	FTNA0306	TW09S

HFMD5-LN06

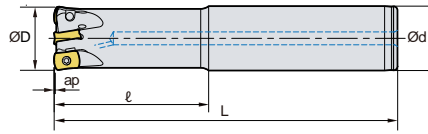

• AR: -9°
• RR: 10°-15°

(mm)

Designation	Stock		ØD	Ød	ℓ	L	ap	
HFMD5 021R-3C20-100-LN06		3	21	20	30	100	1.0	0.21
021R-3C20-130-LN06		3	21	20	40	130	1.0	0.27
021R-3C20-160-LN06	●	3	21	20	40	160	1.0	0.34
021R-3C20-200-LN06	●	3	21	20	40	200	1.0	0.42
025R-4C25-100-LN06		4	25	25	40	100	1.0	0.33
025R-4C25-140-LN06	●	4	25	25	60	140	1.0	0.46
025R-4C25-180-LN06	●	4	25	25	100	180	1.0	0.58
025R-4C25-250-LN06		4	25	25	150	250	1.0	0.67
026R-4C25-100-LN06		4	26	25	30	100	1.0	0.34
026R-4C25-140-LN06		4	26	25	40	140	1.0	0.48
026R-4C25-180-LN06	●	4	26	25	40	180	1.0	0.63
026R-4C25-250-LN06	●	4	26	25	40	250	1.0	0.72
032R-5C32-150-LN06	●	5	32	32	70	150	1.0	0.82
032R-5C32-200-LN06	●	5	32	32	120	200	1.0	1.08
032R-5C32-250-LN06		5	32	32	150	250	1.0	1.20
033R-5C32-150-LN06		5	33	32	40	150	1.0	0.82
033R-5C32-200-LN06	●	5	33	32	40	200	1.0	1.08
033R-5C32-250-LN06	●	5	33	32	40	250	1.0	1.20
035R-5C32-150-LN06		5	35	32	40	150	1.0	0.87
035R-5C32-200-LN06		5	35	32	40	200	1.0	1.13
035R-5C32-250-LN06		5	35	32	40	250	1.0	1.25
040R-6C32-150-LN06		6	40	32	40	150	1.0	0.97
040R-6C32-200-LN06		6	40	32	40	200	1.0	1.28
040R-6C32-250-LN06		6	40	32	40	250	1.0	1.38

● : Stock item

Available Inserts



LNMX-ML



LNMX-MF



LNMX-MM

Designation	Coated				
	UNC840	PC5400	PC5300	PC3700	PC2510
LNMX 060310R-ML	●	●	●	-	-
060310R-MF	●	●	●	●	●
060310R-MM	-	●	●	●	●

Parts

Specification	Screw	Wrench
Ø16~Ø40	FTNA0306	TW09S

HFMDCM-LN06

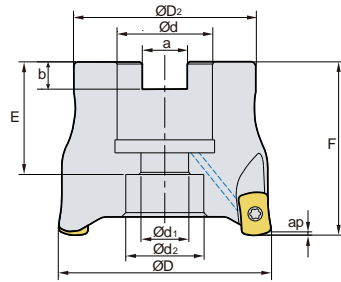

• AR: -9°
• RR: 10°-12°

(mm)

Designation	Stock		ØD	ØD2	Ød	Ød1	Ød2	a	b	E	F	ap	
HFMDCM 032R-16-5-LN06			32	30	16	9	13.5	8.4	5.6	19	40	1.0	0.12
040R-16-6-LN06	●		40	34	16	9	14	8.4	5.6	19	40	1.0	0.21
050R-22-6-LN06			50	42	22	11	18	10.4	6.3	21	40	1.0	0.32
050R-22-7-LN06			50	42	22	11	18	10.4	6.3	21	40	1.0	0.32
050R-22-8-LN06	●		50	42	22	11	18	10.4	6.3	21	40	1.0	0.32
052R-22-7-LN06			52	42	22	11	18	10.4	6.3	21	40	1.0	0.34
052R-22-8-LN06			52	42	22	11	18	10.4	6.3	21	40	1.0	0.34
063R-22-8-LN06			63	49	22	11	18	10.4	6.3	21	40	1.0	0.53
063R-22-9-LN06	●		63	49	22	11	18	10.4	6.3	21	40	1.0	0.53
066R-22-8-LN06			66	49	22	11	18	10.4	6.3	21	40	1.0	0.57
066R-22-9-LN06			66	49	22	11	18	10.4	6.3	21	40	1.0	0.57

● : Stock item

Available Inserts



LNMX-ML



LNMX-MF



LNMX-MM

Designation	Coated				
	UNC840	PC5400	PC5300	PC3700	PC2510
LNMX 060310R-ML	●	●	●	-	-
060310R-MF	●	●	●	●	●
060310R-MM	-	●	●	●	●

Parts

Designation	Screw 	Wrench
Ø32~Ø66	FTNA0306	TW09S

HFMDM-LN06

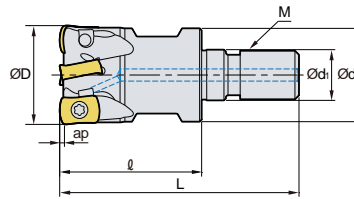

• AR: -9°
• RR: 10°-15°

(mm)

Designation	Stock		ØD	Ød	Ød1	ℓ	L	M	ap	
HFMDM 016R-2-M08-LN06	●	2	16	14.5	8.5	25	42	M08	0.7	0.03
017R-2-M08-LN06	●	2	17	14.5	8.5	25	42	M08	1.0	0.03
018R-2-M08-LN06		2	18	14.5	8.5	25	42	M08	1.0	0.04
019R-2-M08-LN06		2	19	14.5	8.5	25	42	M08	1.0	0.05
020R-3-M10-LN06	●	3	20	18	10.5	30	51	M10	1.0	0.06
021R-3-M10-LN06	●	3	21	18	10.5	30	51	M10	1.0	0.07
025R-4-M12-LN06	●	4	25	23	12.5	35	59	M12	1.0	0.10
026R-4-M12-LN06		4	26	23	12.5	35	59	M12	1.0	0.10
032R-5-M16-LN06	●	5	32	29	17	40	67	M16	1.0	0.20
033R-5-M16-LN06		5	33	29	17	40	67	M16	1.0	0.20
035R-5-M16-LN06		5	35	29	17	40	67	M16	1.0	0.21
040R-6-M16-LN06		6	40	29	17	40	67	M16	1.0	0.24
042R-6-M16-LN06		6	42	29	17	40	67	M16	1.0	0.25

● : Stock item

Available Inserts



LNMX-ML



LNMX-MF



LNMX-MM

Designation	Coated				
	UNC840	PC5400	PC5300	PC3700	PC2510
LNMX 060310R-ML	●	●	●	-	-
060310R-MF	●	●	●	●	●
060310R-MM	-	●	●	●	●

Parts

Designation	Screw 	Wrench
Ø16~Ø42	FTNA0306	TW09S

MAT (Steel Shank)

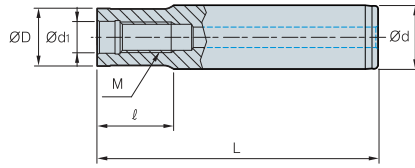

Fig. 1

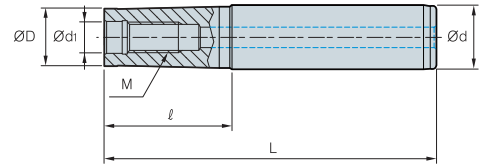

Fig. 2

(mm)

Designation	Stock	ØD	Ød	Ød ₁	ℓ	L	M	Fig.
MAT- M06-020-S10S	●	9.5	10	6.5	20	70	M06	1
M06-040-S12T	●	9.5	12	6.5	40	96	M06	2
M06-065-S16T	●	9.5	16	6.5	65	125	M06	2
M6B-020-S12S	●	11.0	12	6.5	20	76	M06	1
M6B-040-S12S	●	11.0	12	6.5	40	96	M06	1
M6B-065-S16T	●	11.0	16	6.5	65	125	M06	2
M6B-080-S16T	●	11.0	16	6.5	80	140	M06	2
M08-020-S16S	●	14.5	16	8.5	20	80	M08	1
M08-040-S16T	●	14.5	16	8.5	40	100	M08	2
M08-065-S16T	●	14.5	16	8.5	65	125	M08	2
M08-080-S20T	●	14.5	20	8.5	80	150	M08	2
M08-110-S25T	●	14.5	25	8.5	110	190	M08	2
M10-030-S20S	●	18.0	20	10.5	30	100	M10	1
M10-050-S20T	●	18.0	20	10.5	50	120	M10	2
M10-070-S20T	●	18.0	20	10.5	70	140	M10	2
M10-090-S25T	●	18.0	25	10.5	90	170	M10	2
M10-110-S25T	●	18.0	25	10.5	110	190	M10	2
M10-130-S32T	●	18.0	32	10.5	130	220	M10	2
M12-030-S25S	●	22.5	25	12.5	29	110	M12	1
M12-050-S25T	●	22.5	25	12.5	50	130	M12	2
M12-070-S25T	●	22.5	25	12.5	70	150	M12	2
M12-090-S25T	●	22.5	25	12.5	90	170	M12	2
M12-110-S32T	●	22.5	32	12.5	110	200	M12	2
M12-175-S40T	●	22.5	40	12.5	175	300	M12	2
M16-035-S32S	●	28.5	32	17.0	35	125	M16	1
M16-055-S32T	●	28.5	32	17.0	55	145	M16	2
M16-080-S32T	●	28.5	32	17.0	80	170	M16	2
M16-120-S32T	●	28.5	32	17.0	120	210	M16	2
M16-175-S40T	●	28.5	40	17.0	175	300	M16	2

* S: Straight neck adapter * T: Taper neck adapter

● : Stock item

MAT-C (Carbide Shank)

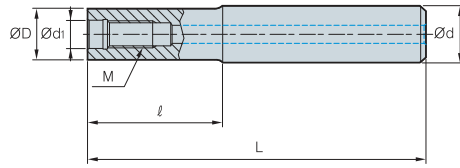

Fig. 1

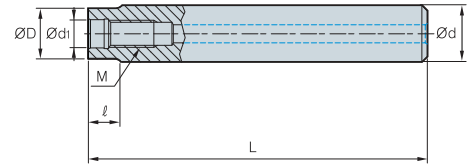

Fig. 2

(mm)

Designation	Stock	ØD	Ød	Ød ₁	ℓ	L	M	Fig.
MAT- M06-030-S10S-C-80		9.5	10	6.5	30	80	M06	1
M06-050-S10S-C-100		9.5	10	6.5	50	100	M06	1
M06-080-S10S-C-130		9.5	10	6.5	80	130	M06	1
M6B-030-S12S-C-80		11	12	6.5	30	80	M06	1
M6B-050-S12S-C-100		11	12	6.5	50	100	M06	1
M6B-080-S12S-C-130		11	12	6.5	80	130	M06	1
M08-080-S16S-C	●	14.5	16	8.5	80	150	M08	1
M08-110-S16S-C	●	14.5	16	8.5	110	180	M08	1
M08-150-S16S-C		14.5	16	8.5	150	250	M08	1
M08-010-S16S-C-150		14.5	16	8.5	10	150	M08	2
M08-010-S16S-C-180		14.5	16	8.5	10	180	M08	2
M08-010-S16S-C-250		14.5	16	8.5	10	250	M08	2
M10-090-S20S-C	●	18	20	10.5	90	170	M10	1
M10-110-S20S-C	●	18	20	10.5	110	200	M10	1
M10-175-S20S-C		18	20	10.5	175	300	M10	1
M10-010-S20S-C-170	●	18	20	10.5	10	170	M10	2
M10-010-S20S-C-200		18	20	10.5	10	200	M10	2
M10-010-S20S-C-300		18	20	10.5	10	300	M10	2
M12-090-S25S-C	●	22.5	25	12.5	90	170	M12	1
M12-110-S25S-C		22.5	25	12.5	110	200	M12	1
M12-175-S25S-C		22.5	25	12.5	175	300	M12	1
M12-015-S25S-C-170		22.5	25	12.5	15	170	M12	2
M12-015-S25S-C-200		22.5	25	12.5	15	200	M12	2
M12-015-S25S-C-300		22.5	25	12.5	15	300	M12	2
M16-090-S32S-C	●	28.5	32	17	90	180	M16	1
M16-120-S32S-C		28.5	32	17	120	210	M16	1
M16-175-S32S-C		28.5	32	17	175	300	M16	1
M16-020-S32S-C-180		28.5	32	17	20	180	M16	2
M16-020-S32S-C-210		28.5	32	17	20	210	M16	2

* S: Straight neck adapter * T: Taper neck adapter

● : Stock item

BT30 / BT40 / BT50

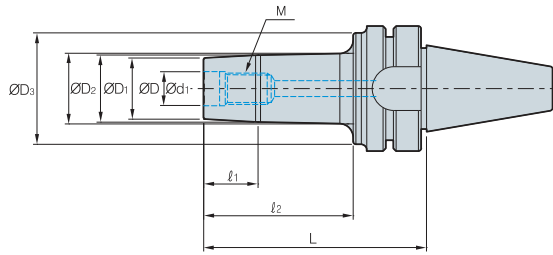

(mm)

Designation	Stock	ØD	ØD1	ØD2	ØD3	Ød1	l1	l2	L	M	
BT30-	MAT-M06-053		11	11.7	13	30	6.5	5	21	53	M06*1.0
	MAT-M08-057		14.5	15.7	17.5	35	8.5	7	25	57	M08*1.25
	MAT-M10-062		18	19.7	24	38	10.5	7	30	62	M10*1.5
	MAT-M12-067		23	24.7	27.5	41	12.5	10	35	67	M12*1.75
	MAT-M16-067		29	31.7	33.5	41	17	10	35	67	M16*2.0
BT40-	MAT-M06-062		11	11.7	14	40	6.5	5	25	62	M06*1.0
	MAT-M06-077		11	11.7	14	40	6.5	5	40	77	M06*1.0
	MAT-M06-092		11	11.7	14	40	6.5	5	55	92	M06*1.0
	MAT-M08-067		14.5	15.7	19	44	8.5	7	30	67	M08*1.25
	MAT-M08-082		14.5	15.7	19	44	8.5	7	45	82	M08*1.25
	MAT-M08-097		14.5	15.7	19	44	8.5	7	60	97	M08*1.25
	MAT-M10-072		18	19.7	23	50	10.5	10	35	72	M10*1.5
	MAT-M10-087		18	19.7	23	50	10.5	10	50	87	M10*1.5
	MAT-M10-102		18	19.7	23	50	10.5	10	65	102	M10*1.5
	MAT-M12-077		23	24.7	30	55	12.5	10	40	77	M12*1.75
	MAT-M12-092		23	24.7	30	55	12.5	13	55	92	M12*1.75
	MAT-M12-107		23	24.7	30	55	12.5	13	70	107	M12*1.75
	MAT-M16-077		29	31.7	37	55	17	13	40	77	M16*2.0
	MAT-M16-092		29	31.7	37	55	17	13	55	92	M16*2.0
	MAT-M16-107		29	31.7	37	55	17	13	70	107	M16*2.0
BT50-	MAT-M06-083		11	11.7	15	40	6.5	5	35	83	M06*1.0
	MAT-M06-098		11	11.7	15	40	6.5	5	50	98	M06*1.0
	MAT-M06-113		11	11.7	15	40	6.5	5	65	113	M06*1.0
	MAT-M08-088		14.5	15.7	20	45	8.5	7	40	88	M08*1.25
	MAT-M08-103		14.5	15.7	20	45	8.5	7	55	103	M08*1.25
	MAT-M08-118		14.5	15.7	20	45	8.5	7	70	118	M08*1.25
	MAT-M10-093		18	19.7	25	55	10.5	10	45	93	M10*1.5
	MAT-M10-113		18	19.7	25	55	10.5	10	65	113	M10*1.5
	MAT-M10-128		18	19.7	25	55	10.5	10	80	128	M10*1.5
	MAT-M12-103		23	24.7	33	65	12.5	10	55	103	M12*1.75
	MAT-M12-118		23	24.7	33	65	12.5	13	70	118	M12*1.75
	MAT-M12-133		23	24.7	33	65	12.5	13	85	133	M12*1.75
	MAT-M16-103		29	31.7	41	85	17	13	55	103	M16*2.0
	MAT-M16-118		29	31.7	41	85	17	13	70	118	M16*2.0
	MAT-M16-133		29	31.7	41	85	17	13	85	133	M16*2.0

● : Stock item

HSK63A / HSK100A

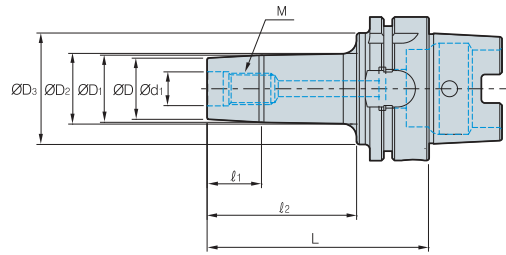

(mm)

Designation	Stock	ØD	ØD1	ØD2	ØD3	Ød1	l1	l2	L	M	
HSK63A-	MAT-M06-061		11	11.7	27	40	6.5	5	25	61	M06*1.0
	MAT-M06-076		11	11.7	27	40	6.5	5	40	76	M06*1.0
	MAT-M06-091		11	11.7	27	40	6.5	5	55	91	M06*1.0
	MAT-M08-066		14.5	15.7	30.5	44	8.5	7	30	66	M08*1.25
	MAT-M08-081		14.5	15.7	30.5	44	8.5	7	45	81	M08*1.25
	MAT-M08-096		14.5	15.7	30.5	44	8.5	7	60	96	M08*1.25
	MAT-M10-071		18	19.7	34	50	10.5	10	35	71	M10*1.5
	MAT-M10-086		18	19.7	34	50	10.5	10	50	86	M10*1.5
	MAT-M10-101		18	19.7	34	50	10.5	10	65	101	M10*1.5
	MAT-M12-076		23	24.7	36.5	55	12.5	10	40	76	M12*1.75
	MAT-M12-091		23	24.7	36.5	55	12.5	13	55	91	M12*1.75
	MAT-M12-106		23	24.7	36.5	55	12.5	13	70	106	M12*1.75
	MAT-M16-076		29	31.7	38.5	55	17	13	40	76	M16*2.0
	MAT-M16-091		29	31.7	38.5	55	17	13	55	91	M16*2.0
MAT-M16-106		29	31.7	38.5	55	17	13	70	106	M16*2.0	
HSK100A-	MAT-M06-074		11	11.7	15	40	6.5	5	35	74	M06*1.0
	MAT-M06-089		11	11.7	15	40	6.5	5	50	89	M06*1.0
	MAT-M06-104		11	11.7	15	40	6.5	5	65	104	M06*1.0
	MAT-M08-079		14.5	15.7	20	45	8.5	7	40	79	M08*1.25
	MAT-M08-094		14.5	15.7	20	45	8.5	7	55	94	M08*1.25
	MAT-M08-109		14.5	15.7	20	45	8.5	7	70	109	M08*1.25
	MAT-M10-084		18	19.7	25	55	10.5	10	45	84	M10*1.5
	MAT-M10-104		18	19.7	25	55	10.5	10	65	104	M10*1.5
	MAT-M10-119		18	19.7	25	55	10.5	10	80	119	M10*1.5
	MAT-M12-094		23	24.7	33	65	12.5	10	55	94	M12*1.75
	MAT-M12-109		23	24.7	33	65	12.5	13	70	109	M12*1.75
	MAT-M12-124		23	24.7	33	65	12.5	13	85	124	M12*1.75
	MAT-M16-094		29	31.7	41	85	17	13	55	94	M16*2.0
	MAT-M16-109		29	31.7	41	85	17	13	70	109	M16*2.0
MAT-M16-124		29	31.7	41	85	17	13	85	124	M16*2.0	

● : Stock item

www.korloy.com



Holystar B/D, 1350, Nambusunhwan-ro, Geumcheon-gu, Seoul, 08536, Korea
Tel : +82-2-522-3181 Fax : +82-2-522-3184, +82-2-3474-4744 Web : www.korloy.com E-mail : export@korloy.com

KORLOY AMERICA

620 Maple Avenue, Torrance, CA 90503, USA
Tel : +1-310-782-3800 Toll Free : +1-888-711-0001 Fax : +1-310-782-3885
E-mail : sales.kai@korloy.com

KORLOY INDIA

Plot NO.415, Sector 8, IMT Manesar, Gurgaon 122051, Haryana, India
Tel : +91-124-4391790 Fax : +91-124-4050032
E-mail : sales.kip@korloy.com

KORLOY VIETNAM

No. 133, Le Loi street, Hoa Phu ward, Thu Dau Mot city,
Binh Duong, Vietnam
Tel : +84-96-856-1230 E-mail : sales.kvc@korloy.com

KORLOY CHILE

Av. Providencia 1650, Office 1009, 7500027
Providencia-Santiago, Chile
Tel : +56-229-295-490 E-mail : sales.kcs@korloy.com

KORLOY FACTORY QINGDAO

Ground Dongjing Road 56(B) District Free Trade Zone. Qingdao, China
Tel : +86-532-86959880 Fax : +86-532-86760651
E-mail : pro.kfq@korloy.com

KORLOY EUROPE

Gablonzer Str. 25-27, 61440 Oberursel, Germany
Tel : +49-6171-277-83-0 Fax : +49-6171-277-83-59
E-mail : sales.keg@korloy.com

KORLOY BRASIL

Av. Aruana 280, conj.12, WLC, Alphaville, Barueri,
CEP06460-010, SP, Brasil
Tel : +55-11-4193-3810 E-mail : sales.kbl@korloy.com

KORLOY TURKEY

Orucreis Mah. Vadi Cad. No: 108 Istanbul Ticaret Sarayi
Kat 5 No: 318 Giyimkent Sitesi-Esenler/Istanbul, Turkey
Tel : +90-212-438-5197 E-mail : service@korloy.com.tr

KORLOY FACTORY INDIA

Plot No. 415, Sector 8, IMT Manesar, Gurgaon 122051, Haryana, India
Tel : +91-124-4391790 Fax : +91-124-4050032
E-mail : pro.kim@korloy.com