

Pro-V Mill



The Premium High-Speed Milling Tool for Aluminum

The New Premium Milling Tool Line for Aluminum Machining

- ▣ **Enhanced Productivity**
Increased productivity due to high speed capability
- ▣ **Improved Surface Finish**
Excellent surface finish and perpendicularity with high-precision products
- ▣ **Excellent Clamping Stability**
Satisfactory clamping force of inserts by the use of the key shape



The Premium High-Speed Milling Tool for Aluminum

Pro-V Mill



Inserts



Cutters



Shanks

KORLOY introduces a new premium milling product line for aluminum, Pro-V Mill. Development of this product has allowed high speed capability in aluminum machining, leading to an immense increase in productivity.

The huge impact given during high speed machining would change the position of the insert and cause tool breakage consequently. And the existing clamping method was not able to endure this impact. To overcome this kind of limit, a new clamping system has been applied. This new clamping method features enhanced clamping force at high speeds, providing reliable machining stability even when inserts get a shock.

KORLOY applied a new key to key slot clamping system to our new product, Pro-V Mill, in order to increase the clamping force. With stable cutting performance at high speed, it remarkably improves productivity and surface finish compared to the existing products. Furthermore, the rake surface of the insert was treated with a mirror-like finish to avoid built-up edge issues. Various nose radius inserts are available to meet the needs of different applications.

Combined with the highly lubricative DLC grade PD1010, Pro-V Mill can improve the surface finish and product life.

- Excellent clamping stability

- **Strong clamping force at high speeds**
- **Reduced vibrations and noises**

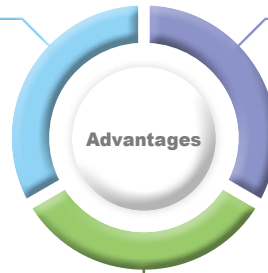

- Advanced productivity

- **Higher table feed due to increased rpm**

- Improved surface finish

- **Enhanced surface roughness and perpendicularity due to high speed capability**



⇒ Code System

[Shank Type]

PAV	S	032	R	- 2	C	32 - 150	- XD19	- A
Pro-V Mill		Machining Dia. 032: Ø32		No. of teeth 2: 2 teeth	Shank type C: Cylinder W: Weldon	Shank Dia. 032: Ø32	Overall length 150: 150mm	Applicable insert XD19: XDET19
	Type S: Shank		Oil hole and hand R: Right hand with oil holes NR: Right hand without oil holes					Insert nose R A: Nose R 3.2 or lower B: Nose R 4.0 or higher

[Cutter Type]

PAV	C	M	050	R	- 22	- 4	- XD19	- A
Pro-V Mill	Type C: Cutter	Arbor type M: Metric A: Inch None: Asia	Machining Dia. 050: Ø50	Oil hole and hand R: Right hand with oil holes NR: Right hand without oil holes	Internal Dia. 22: 22mm	No. of teeth 4: 4 teeth	Applicable insert XD19: XDET19	Insert nose R A: Nose R 3.2 or lower B: Nose R 4.0 or higher

[Tooling System]

HSK63A	- PAV	050	R	- 4	- 100	- XD19	- A
Arbor type	Pro-V Mill	Machining Dia. 050: Ø50	Oil hole and hand R: Right hand with oil holes NR: Right hand without oil holes	No. of teeth 4: 4 teeth	Overall length 100: 100mm	Applicable insert XD19: XDET19	Insert nose R A: Nose R 3.2 or lower B: Nose R 4.0 or higher

- The combined clamping system of the key to key slot structure and simple screw-on type ensures strong clamping force
→ Stable Machining / Prevention of insert breakage
- Avoiding uplifting problems of insert due to axial acute-angle clamping of cutters
→ Reduced vibrations and excellent surface finish

⇒ Cutter Features



Screw-on clamping

- New screw shape

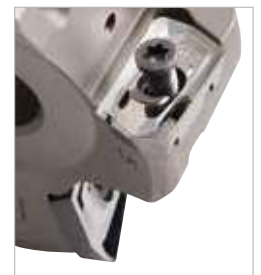

Axial acute-angle clamping

- Inhibition of the axial force



Insert clamping area

- Stable clamping force due to the key to key slot structure



➔ Insert Features

Wide minor cutting edges

- Improved surface finish

Mirror-like finish of the rake surface of insert

- Avoiding build-up edges through smooth chip flow



High-rake chip breaker and helix cutting edges

- High rake and lower cutting load

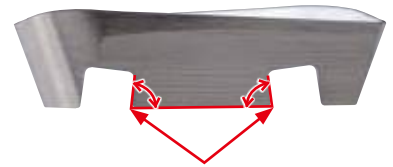

Application of the key slot design

- The bottom key of insert and the key slot in an acute angle
- High clamping stability of the holder contact area
→ Improved clamping force

➔ Chip Breaker Features

- Chip breaker
MA

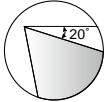

Chip breaker	Cutting-edge design	Application	Features
MA		For non-ferrous metals	<ul style="list-style-type: none"> ▪ Ensuring satisfactory machining quality with the application of mirror-like cutting edges optimized for aluminum machining

➔ Recommended Cutting Conditions

Workpiece		Grade	vc (m/min)	Max. ap (mm)	
N	Aluminum			17	
		Si ≤ 5% (Si Lower than 5%)	H01		1,300 (500 - 2,200)
			H05		1,000 (300 - 1,700)
			PD1005		1,500 (500 - 3,000)
	Si ≤ 10% (Si Lower than 10%)	PD1010	1,200 (300 - 2,200)		

※ The recommended cutting conditions above are a general guideline. Their details may vary depending on the machining method of users and other conditions.

AI Machining Tool Selection Guide

Selection system of tools

■ Pro-V Mill ■ Pro-X Mill ■ Pro-A Mill

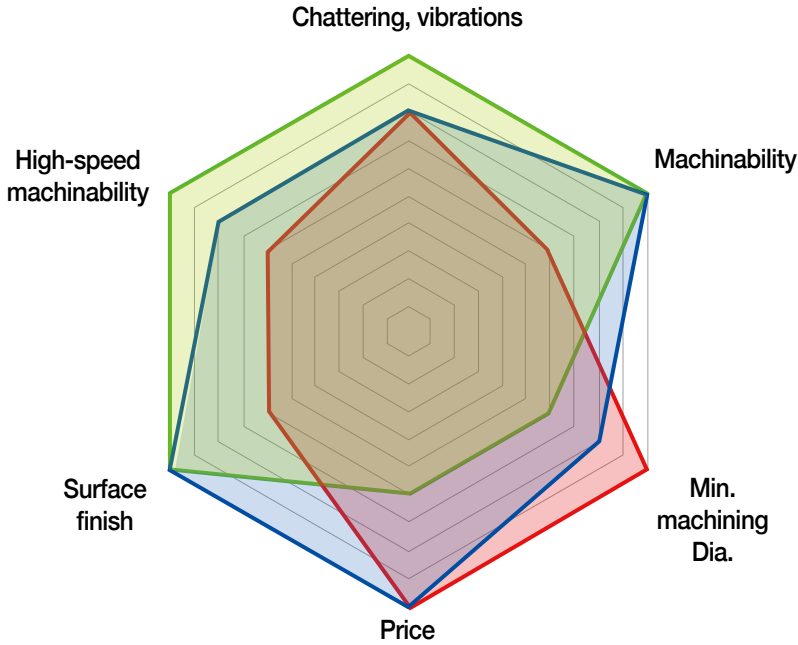

Pro-V Mill *New*

- Aluminum high-speed machining up to vc 3,000 (m/min)



Pro-X Mill

- Aluminum high-speed machining up to vc 2,000 (m/min)



Pro-A Mill

- Small diameter machining Min. $\varnothing 0.5$



Product name	Chattering, vibrations	High-speed machinability	Machinability	Surface finish	Min. machining Dia.	Price
Pro-V Mill <i>New</i>	★★★★★	★★★★★	★★★★★	★★★★★	★★	★★
Pro-X Mill	★★★	★★★	★★★★★	★★★★★	★★★	★★★★★
Pro-A Mill	★★	★★	★★	★★	★★★★★	★★★★★

Application Range

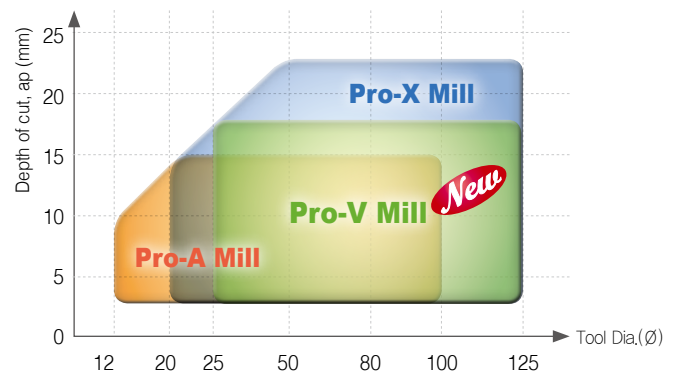
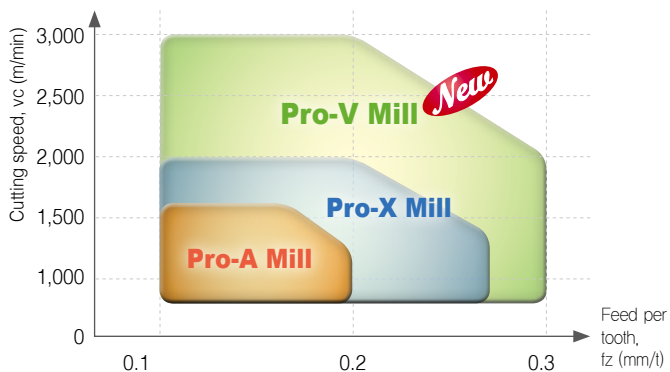

⇒ Grades Selection Guide

• **PD1005**: for high speed, outstanding surface finish in the continuous cutting of general non-ferrous metals

• **PD1010**: provides stable and exceptional tool life when machining of non-ferrous metals with high hardness or interrupted machining

- **Uncoated carbide grade (H01/H05)**: a fine alloy structure suitable for cutting, with excellent wear resistance and toughness
- **DLC Grade (PD1005/PD1010)**: application of DLC coating with high hardness and reduced friction for high speed and superior surface roughness

Workpiece		ISO	Application range	
N	Non-ferrous metal	Aluminum, Copper	N05	H01
			N10	
	Aluminum alloy	N15	PD1005	
		N20		
	Al-Si alloy	N25	PD1010	
		N30		

⇒ Hard H-DLC coating

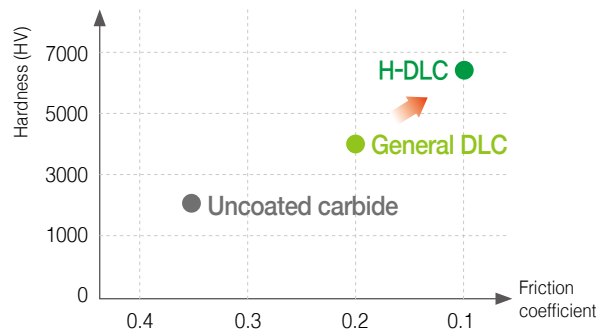

- Application of DLC (Diamond Liked Carbon) coating technology with high hardness and reduced friction
- Improved machinability and machining quality due to maximized wear resistance and lubrication
- Stable and long tool life due to substrate optimized for workpieces
- Suitable for machining of non-ferrous metal such as aluminum, Al-Si alloy, and copper

⇒ Hard H-DLC coating

DLC coating

- Diamond-Like Carbon
- Amorphous carbon coating with physical properties similar to those of diamonds
- High hardness and lubrication ideal for non-ferrous metal machining with a high probability of build-up edge occurring

DLC coating of high hardness



General DLC

- Hardness of coating: 3000 HV
- Friction coefficient: < 0.25



Hard DLC

- Hardness of coating: 6500 HV
- Friction coefficient: < 0.15



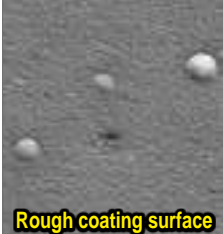

Rough coating surface

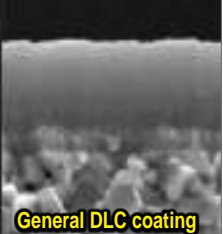

General DLC coating

→

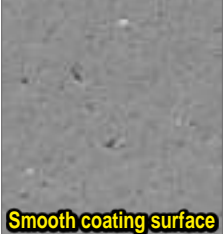

Smooth coating surface



Hard DLC coating

⇒ Application Guideline for Grade

PD1005 / PD1010

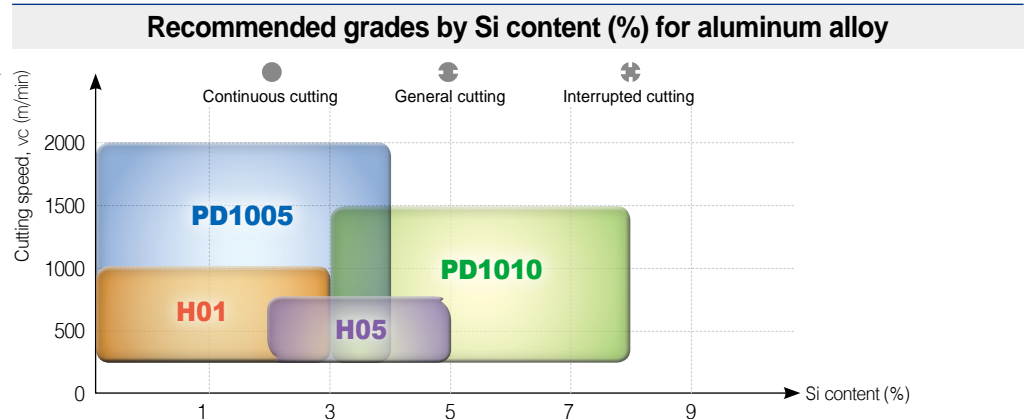
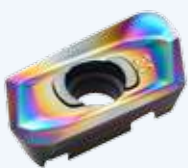

⇒ Performance Evaluation

- Workpiece AlZn5.5MgCu(ISO), 7075(AISI), A7075S(KS), 300(L) x 200(W) x 100(h), rectangular tube
- Cutting conditions $\varnothing 63$, vc (m/min) = 3560, fz (mm/t) = 0.2, ap (mm) = 15 ae (mm) = 20, Wet
- Machining method Shouldering
- Tools Insert XDET190508PEFR-MA (H01) Holder BT40-PAV063R-4-100-XD19-A

- Increased wear resistance of inserts due to stable clamping even in interrupted machining at high speeds
→ Longer tool life
- The cutting-edge design minimizes cutting resistance and reduces cutting noises and vibrations

Evaluation of chipping resistance



[Existing products]



[Pro-V Mill]

⇒ Perpendicularity Evaluation

- Workpiece AlZn5.5MgCu(ISO), 7075(AISI), A7075S (KS), 300(L) x 200(W) x 100(h), rectangular tube
- Cutting conditions $\varnothing 32$, vc (m/min) = 1,000, fz (mm/t) = 0.12, ap (mm) = 15, ae (mm) = 10, Wet
- Machining method Perpendicularity and shoulder surface finish checked after a single pass of 15 mm
- Tools Insert XDET190508PEFR-MA (H01) Holder PAVS032R-2C32-150-XD19-A

- More stable clamping enables more stable machining
→ Improved perpendicularity

Perpendicularity evaluation

■ Pro-V Mill ■ Existing products

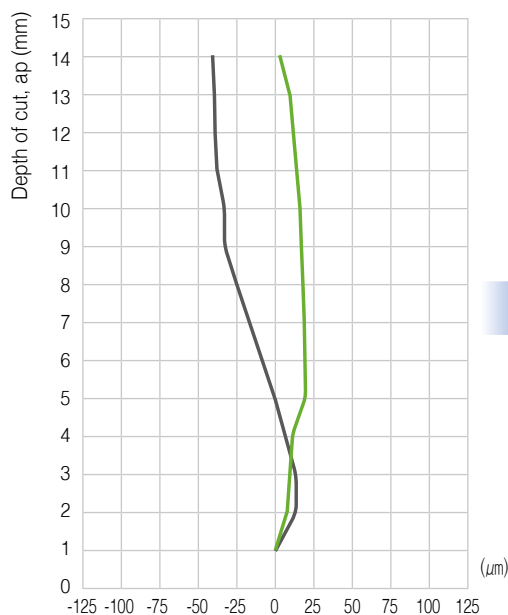

[Graph comparing the measured perpendicularity]



[Picture comparing the shoulder surface roughness]

➤ Ramping and Helical Cutting

1. Ramping

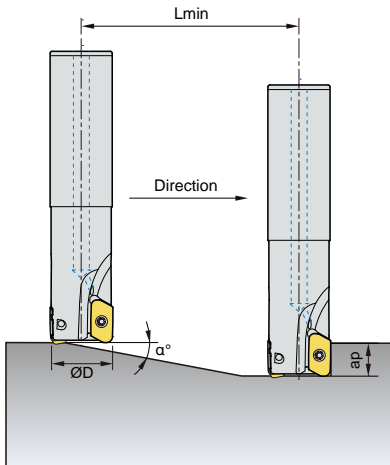

2. Helical cutting for blind hole

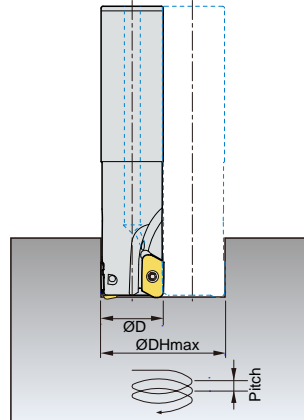

3. Helical cutting for through hole

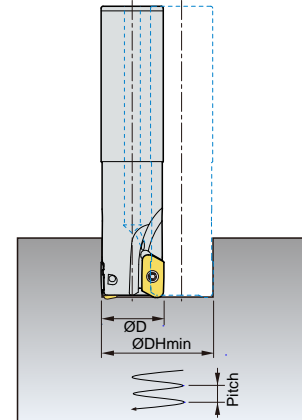

* Limits following Nose R 3.0 standard

(mm)

Tool Dia. ØD	1. Ramping		2. Helical cutting for blind hole				3. Helical cutting for through hole	
	Max. rake angle α°	Lmin	Min. machining Dia. ØDHmin	Max. pitch	Max. machining Dia. ØDHmax	Max. pitch	Min. machining Dia. ØDHmin	Max. pitch
25	15.0	59	41	13.0	44	15.5	27	2.0
32	10.0	99	55	11.0	58	12.5	41	4.5
40	7.0	142.5	71	10.5	74	11.5	57	6.0
50	5.0	200	91	10.0	94	10.5	77	6.5
63	3.5	286	117	9.2	120	9.5	103	7.0
80	2.6	385	151	9.0	154	9.5	137	7.3
100	2.0	501	191	9.0	194	9.0	177	7.6
125	1.5	668	241	8.5	244	8.5	227	7.5

• When ramping and helical milling, table feed, vf (mm/min) should be lower than 70% of the recommended cutting conditions.

• When helical milling, Max. pitch, DHmax should be lower than max. depth of cut, ap.

• When ramping, the depth of cut should be lower than max. depth of cut, ap.

• $Lmin = ap / \tan(\alpha^\circ)$ (mm)

• Lmin : Min. length of ramping

• ap : Depth of cut

• α° : Max. rake angle in ramping

➤ Applicable Inserts

Insert shape	Designation	Coated		Uncoated		Dimensions (mm)					Figure
		PD1005	PD1010	H01	H05	l	d	t	r	d ₁	
	XDET			●	●	22	11.3	5.04	0.4	4.5	
				●	●	22	11.3	5.00	0.8	4.5	
				●	●	22	11.3	5.00	1.2	4.5	
				●	●	22	11.3	4.99	1.6	4.5	
				●	●	22	11.3	4.97	2.0	4.5	
				●	●	22	11.3	4.95	2.4	4.5	
				●	●	22	11.3	4.93	3.0	4.5	
				●	●	22	11.3	4.92	3.2	4.5	
				●	●	21	11.3	4.85	4.0	4.5	
				●	●	21	11.3	4.81	5.0	4.5	

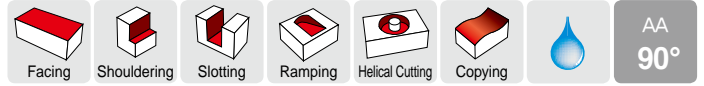

AA
90°
•AR: 11°~14°
•RR: -11°~-9°

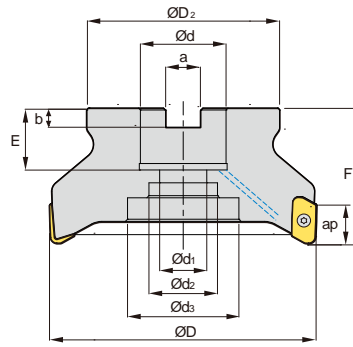

(mm)

Designation	Stock		⊙	ØD	ØD ₂	Ød	Ød ₁	Ød ₂	Ød ₃	a	b	E	F	ap	kg
	A	B													
PAVCM 040R-16-3-XD19-A,B	●		3	40	34	16	9	13.5	-	8.4	5.6	16	45	17	0.17
050R-22-4-XD19-A,B	●		4	50	42	22	11	18	-	10.4	6.3	21	50	17	0.35
063R-22-5-XD19-A,B	●		5	63	42	22	11	18	-	10.4	6.3	21	50	17	0.53
080R-27-5-XD19-A,B	●		5	80	60	27	14	20	-	12.4	7.0	24	50	17	0.88
100R-32-6-XD19-A,B	●		6	100	70	32	18	26	42	14.4	8.0	25	63	17	1.72
125R-40-7-XD19-A,B	●		7	125	90	40	22	32	52	16.4	9.0	29	63	17	2.82

* Type A uses Insert Nose R 0.4~3.2, and Type B uses Nose R 4.0 ~ 5.0

● : Stock item

* When using a spindle at high speed, please check the balance of tool and use it after replacing with the new screw.

Applicable Inserts



XDET-MA

Designation	Coated		Uncoated	
	PD1005	PD1010	H01	H05
XDET 190504PEFR-MA				●
190508PEFR-MA				●
190512PEFR-MA				●
190516PEFR-MA				●
190520PEFR-MA				●
190524PEFR-MA				●
190530PEFR-MA				●
190532PEFR-MA				●
190540PEFR-MA				●
190550PEFR-MA				●

Applicable Arbor

Designation	Applicable Arbor
PAVCM 040R-16-3-XD19	BT□□-FMC16-□□
050R-22-4-XD19	BT□□-FMC22-□□
063R-22-5-XD19	
080R-27-5-XD19	BT□□-FMC27-□□
100R-32-6-XD19	BT□□-FMC32-□□
125R-40-7-XD19	BT□□-FMC40-□□

Parts

Specification	Screw	Wrench
Ø40 ~ Ø125	PTKA0408-A	TW15S

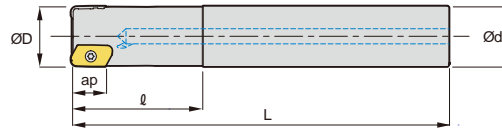
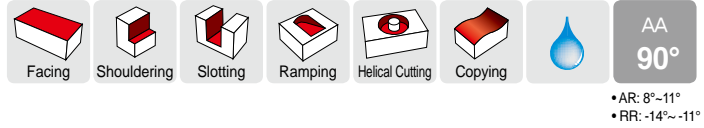

(mm)

Designation	Stock		⊙	ØD	Ød	ℓ	L	ap	kg	
	A	B								
PAVS	025R-2C25-140-XD19-A,B	●		2	25	25	60	140	17	0.40
	032R-2C32-150-XD19-A,B	●		2	32	32	70	150	17	0.76
	032R-2C32-200-XD19-A,B	●		2	32	32	70	200	17	1.06
	040R-3C40-200-XD19-A,B	●		3	40	40	70	200	17	1.71

* Type A uses Insert Nose R 0.4~3.2, and Type B uses Nose R 4.0 ~ 5.0

● : Stock item

* When using a spindle at high speed, please check the balance of tool and use it after replacing with the new screw.

Applicable Inserts



XDET-MA

Designation	Coated		Uncoated	
	PD1005	PD1010	H01	H05
XDET 190504PEFR-MA				●
190508PEFR-MA				●
190512PEFR-MA				●
190516PEFR-MA				●
190520PEFR-MA				●
190524PEFR-MA				●
190530PEFR-MA				●
190532PEFR-MA				●
190540PEFR-MA				●
190550PEFR-MA				●

Parts

Specification	Screw	Wrench
Ø25 ~ Ø40	PTKA0408-A	TW15S

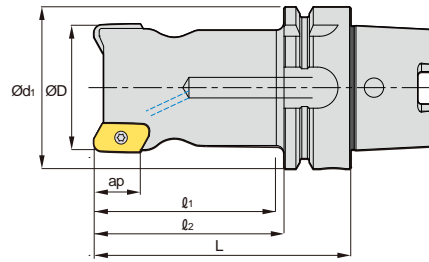
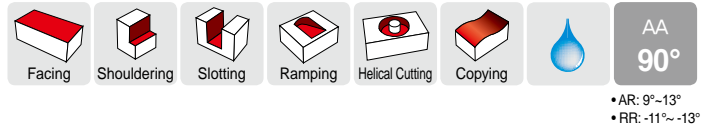

(mm)

Designation	Stock		Z	ØD	Ød ₁	l ₁	l ₂	L	ap	kg
	A	B								
HSK63A	PAV-032R-3-100-XD19-A,B		3	32	63	60	74	100	17	0.97
	PAV-050R-3-100-XD19-A,B		3	50	63	72	74	100	17	1.37

* Type A uses Insert Nose R 0.4~3.2, and Type B uses Nose R 4.0 ~ 5.0

● : Stock item

* When using a spindle at high speed, please check the balance of tool and use it after replacing with the new screw.

Applicable Inserts



XDET-MA

Designation	Coated		Uncoated	
	PD1005	PD1010	H01	H05
XDET 190504PEFR-MA				●
190508PEFR-MA				●
190512PEFR-MA				●
190516PEFR-MA				●
190520PEFR-MA				●
190524PEFR-MA				●
190530PEFR-MA				●
190532PEFR-MA				●
190540PEFR-MA				●
190550PEFR-MA				●

Parts

Specification	Screw	Wrench
Ø32 ~ Ø50	PTKA0408-A	TW15S

www.korloy.com



Holystar B/D, 1350, Nambusunhwan-ro, Geumcheon-gu, Seoul, 08536, Korea
Tel : +82-2-522-3181 Fax : +82-2-522-3184, +82-2-3474-4744 Web : www.korloy.com E-mail : export@korloy.com

KORLOY AMERICA

620 Maple Avenue, Torrance, CA 90503, USA
Tel : +1-310-782-3800 Toll Free : +1-888-711-0001 Fax : +1-310-782-3885
E-mail : sales.kai@korloy.com

KORLOY INDIA

Plot NO.415, Sector 8, IMT Manesar, Gurgaon 122051, Haryana, India
Tel : +91-124-4391790 Fax : +91-124-4050032
E-mail : sales.kip@korloy.com

KORLOY VIETNAM

No. 133, Le Loi street, Hoa Phu ward, Thu Dau Mot city,
Binh Duong, Vietnam
Tel : +84-96-856-1230 E-mail : sales.kvc@korloy.com

KORLOY CHILE

Av. Providencia 1650, Office 1009, 7500027
Providencia-Santiago, Chile
Tel : +56-229-295-490 E-mail : sales.kcs@korloy.com

KORLOY FACTORY QINGDAO

Ground Dongjing Road 56(B) District Free Trade Zone. Qingdao, China
Tel : +86-532-86959880 Fax : +86-532-86760651
E-mail : pro.kfq@korloy.com

KORLOY EUROPE

Gablonzer Str. 25-27, 61440 Oberursel, Germany
Tel : +49-6171-277-83-0 Fax : +49-6171-277-83-59
E-mail : sales.keg@korloy.com

KORLOY BRASIL

Av. Aruana 280, conj.12, WLC, Alphaville, Barueri,
CEP06460-010, SP, Brasil
Tel : +55-11-4193-3810 E-mail : sales.kbl@korloy.com

KORLOY TURKEY

Orucreis Mah. Vadi Cad. No: 108 Istanbul Ticaret Sarayi
Kat 5 No: 318 Giyimkent Sitesi-Esenler/Istanbul, Turkey
Tel : +90-212-438-5197 E-mail : service@korloy.com.tr

KORLOY FACTORY INDIA

Plot No. 415, Sector 8, IMT Manesar, Gurgaon 122051, Haryana, India
Tel : +91-124-4391790 Fax : +91-124-4050032
E-mail : pro.kim@korloy.com