

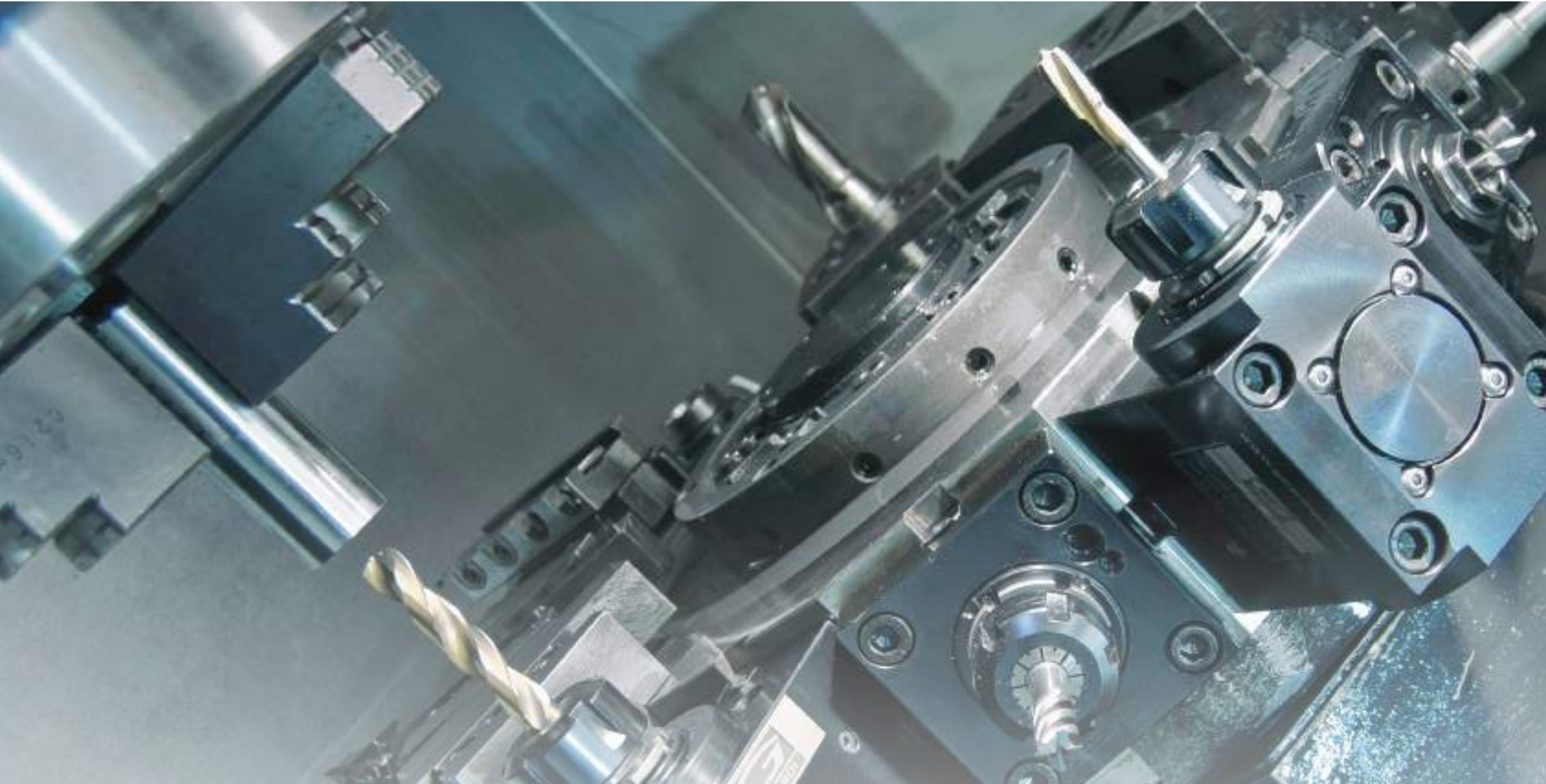

GERARDI
DRIVEN TOOLS





LATHE MODELS COMPATIBLES:

**DIN
5480**

- VDI 30
- VDI 40
- VDI 50
- VDI 60

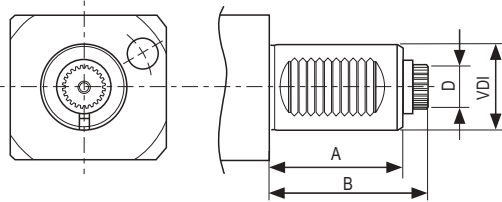

VDI	A	B	D
20	35	51	10,8
25	48	57	13,8
30	55	67	15,8
40	63	75	19,8
50	78	93	23,8



Presca di Moto - Coupling

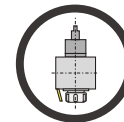

AX

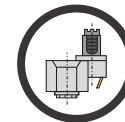

Off AX

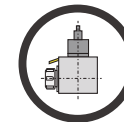

RD

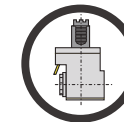

RO

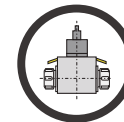

RD-2U

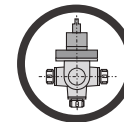

UN

Code		Orient	VDI	Rotation	Output	Int. Cool.	Nm	Rpm	H	
99.ST.8002	DIN 5480	AX	25	▼	ER-25	-	20	6000	60	
99.ST.8003		AX	30	▼	ER-25	-	32	6000	66	
99.ST.8004		AX	30	▼	ER-25	-	32	6000	94	
99.ST.8005		AX	40	▼	ER-32	-	63	6000	95	
99.ST.8006		AX	40	▼	ER-32	-	63	6000	115	
99.ST.8007		AX	50	▼	ER-40	-	100	4000	88	
99.ST.8008		AX	50	▼	ER-40	-	100	4000	120	
99.ST.8010		AX	25	▼	ER-25	● 25bar	32	6000	69	
99.ST.8011		AX	30	▼	ER-25	● 25bar	32	6000	66	
99.ST.8012		AX	30	▼	ER-25	● 25bar	32	6000	94	
99.ST.8013		AX	40	▼	ER-32	● 25bar	63	6000	95	
99.ST.8014		AX	40	▼	ER-32	● 25bar	63	6000	115	
99.ST.8015		AX	50	▼	ER-40	● 25bar	100	4000	120	
99.ST.8016		AX	50	▼	ER-40	● 25bar	100	4000	155	
99.ST.8018		AX	25	▼	ER-16	-	5	24.000 (1:4)	98,5	98,5
99.ST.8020		AX	40	▼	ER-20	-	16	16.000 (1:4)	112,5	112,5
99.ST.8021		AX	50	▼	ER-20	-	25	16.000 (1:4)	128,5	128,5
99.ST.8023		AX	25	▼	* PF-Ø16	-	20	6000	110,5	110,5
99.ST.8024		AX	30	▼	* PF-Ø22	-	32	6000	112	112
99.ST.8025		AX	40	▼	* PF-Ø22	-	63	6000	102	102

Code		Orient	VDI	Rotation	Output	Int. Cool.	Nm	Rpm	H
99.ST.8026	DIN 5480	AX	50	▼	* PF-Ø22	-	100	6000	138
99.ST.8027		AX	50	▼	* PF-Ø27	-	100	4000	138
99.ST.8029		RD	25	▼	ER-25	-	20	6000	75
99.ST.8030		RD	30	▼	ER-25	-	32	6000	55
99.ST.8031		RD	30	▼	ER-25	-	32	6000	85
99.ST.8032		RD	30	▼	ER-25	-	32	6000	100
99.ST.8033		RD	40	▼	ER-32	-	63	6000	100
99.ST.8034		RD	40	▼	ER-32	-	63	6000	120
99.ST.8035		RD	50	▼	ER-40	-	100	4000	110
99.ST.8037		RD	25	▼	ER-25	● 25bar	20	6000	75
99.ST.8038		RD	30	▼	ER-25	● 25bar	32	6000	55
99.ST.8039		RD	30	▼	ER-25	● 25bar	32	6000	85
99.ST.8040		RD	30	▼	ER-25	● 25bar	32	6000	100
99.ST.8041		RD	40	▼	ER-32	● 25bar	63	6000	100
99.ST.8042		RD	40	▼	ER-32	● 25bar	63	6000	120
99.ST.8043		RD	50	▼	ER-40	● 25bar	100	4000	110
99.ST.8045		RO	25	▼	ER-20	-	20	6000	75
99.ST.8046		RO	30	▼	ER-25	-	32	5000	85
99.ST.8047		RO	30	▼	ER-25	-	32	5000	100
99.ST.8048		RO	40	▼	ER-32	-	63	6000	100

Code	Orient	VDI	Rotation	Output	Int Cool.	Nm	Rpm	H
99.ST.8049	RO	50	▼	ER-40	-	100	4000	110
99.ST.8051	RO	25	▼	ER-20	● 25bar	20	6000	75
99.ST.8052	RO	30	▼	ER-25	● 25bar	32	5000	85
99.ST.8053	RO	30	▼	ER-25	● 25bar	32	5000	100
99.ST.8054	RO	40	▼	ER-32	● 25bar	63	6000	100
99.ST.8055	RO	50	▼	ER-40	● 25bar	100	4000	110
99.ST.8057	RO	25	▼	ER-16	-	5	24.000 (1:4)	90
99.ST.8058	RO	30	▼	ER-16	-	8	21.000 (1:4)	95
99.ST.8059	RO	40	▼	ER-20	-	16	16.000 (1:4)	125
99.ST.8060	RO	50	▼	ER-20	-	25	16.000 (1:4)	135
99.ST.8070	RD	25	▼	* PF-Ø16	-	40	3000 (2:1)	75
99.ST.8071	RD	30	▼	* PF-Ø22	-	63	2500 (2:1)	55
99.ST.8072	RD	30	▼	* PF-Ø22	-	63	2500 (2:1)	85
99.ST.8073	RD	30	▼	* PF-Ø22	-	63	2500 (2:1)	100
99.ST.8074	RD	40	▼	* PF-Ø22	-	63	3000 (2:1)	100

Code	Orient	VDI	Rotation	Output	Int. Cool.	Nm	Rpm	H
99.ST.8075	RD	40	▼	* PF-Ø22	-	63	3000 (2:1)	120
99.ST.8076	RD	50	▼	* PF-Ø27	-	100	2000 (2:1)	110
99.ST.8078	RD 2U	25	▼	ER-20-20	-	20	6000	75
99.ST.8079	RD 2U	30	▼	ER-25-25	-	32	5000	85
99.ST.8080	RD 2U	30	▼	ER-25-25	-	32	5000	100
99.ST.8081	RD 2U	40	▼	ER-32-32	-	63	6000	100
99.ST.8082	RD 2U	40	▼	ER-32-32	-	63	6000	120
99.ST.8087	UN ±90°	30	▼	ER-20	● 25bar	15	6000	64
99.ST.8088	UN ±90°	30	▼	ER-20	● 25bar	15	6000	97
99.ST.8089	UN ±90°	40	▼	ER-25	● 25bar	25	4000	81
99.ST.8090	UN ±90°	50	▼	ER-40	● 25bar	50	4000	123
99.ST.8091	UN ±90°	30	▼	ER-20	● 25bar	15	6000	64
99.ST.8092	UN ±90°	30	▼	ER-20	● 25bar	15	6000	97
99.ST.8093	UN ±90°	40	▼	ER-25	● 25bar	25	4000	81



- * PF Portafresa - Shell end milling cutter
- Refrigerante Interno - Internal Coolant
- (C) (▼) Disponibile variante con senso di rotazione uguale al mandrino
Available type with direction of rotation same as machine spindle
- ▼ Senso di rotazione opposto al mandrino
Direction of rotation opposite of machine spindle
- ▼ Senso di rotazione uguale al mandrino
Direction of rotation same as machine spindle

LATHE MODELS COMPATIBLES:



AX
Assiale
Axial

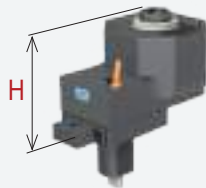

Off-AX
Assiale disassato
Off-set axis

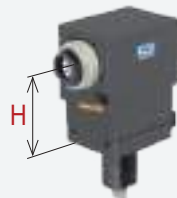

RD
Radiale
Radial

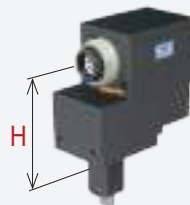

RO
Arretrato
Rear Off-set

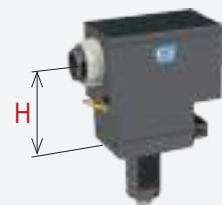

RD - 2U
Radiale Doppia uscita
Radial double output



UN
Regolabile ±90°
±90° Adjustable

LATHE MODELS COMPATIBLES:

DIN 5482

- VDI 20
- VDI 30
- VDI 40
- VDI 50

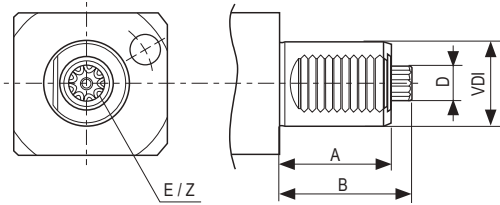

VDI	A	B	D
30	45	55	14,5
40	53	63	16,5
50	78	93	19,5
60	94	108	24,5



Presa di Moto - Coupling

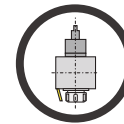

AX

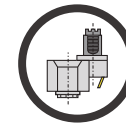

Off AX

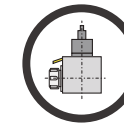

RD

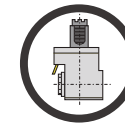

RO

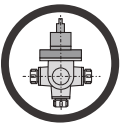

UN

Code		Orient	VDI	Rotation	Output	Int. Cool.	Nm	Rpm	H
99.ST.8201	DIN 5482	AX	30	▼	ER-25	-	32	6000	94
99.ST.8203		AX	40	▼	ER-32	-	63	5000	115
99.ST.8205		AX	50	▼	ER-40	-	100	4000	150
99.ST.8206		AX	60	▼	ER-50	-	160	3200	220
99.ST.8207		AX	30	▼	ER-25	• 25bar	32	6000	94
99.ST.8208		AX	40	▼	ER-32	• 25bar	63	5000	115
99.ST.8210		AX	50	▼	ER-40	• 25bar	100	4000	133
99.ST.8211		AX	60	▼	ER-50	• 25bar	160	3200	228
99.ST.8212		AX	30	▼	ER-16	-	8	20000 (1:4)	100
99.ST.8213		AX	40	▼	ER-20	-	16	16000 (1:4)	112,5
99.ST.8214		AX	50	▼	ER-20	-	25	16000 (1:4)	128,5
99.ST.8215		AX	30	▼	* PF-Ø22	-	32	6000	112
99.ST.8216		AX	40	▼	* PF-Ø22	-	63	5000	124
99.ST.8217		RD	30	▼	ER-25	-	32	6000	55
99.ST.8220		RD	40	▼	ER-32	-	63	5000	100
99.ST.8221		RD	50	▼	ER-40	-	100	4000	110

Code		Orient	VDI	Rotation	Output	Int. Cool.	Nm	Rpm	H
99.ST.8222	DIN 5482	RD	60	▼	ER-50	-	160	3200	130
99.ST.8223		RD	30	▼	ER-25	• 25bar	32	6000	55
99.ST.8226		RD	40	▼	ER-32	• 25bar	63	5000	100
99.ST.8227		RD	50	▼	ER-40	• 25bar	100	4000	110
99.ST.8228		RD	60	▼	ER-50	• 25bar	160	3200	130
99.ST.8229		RO	30	▼	ER-25	-	32	6000	85
99.ST.8230		RO	40	▼	ER-32	-	63	5000	100
99.ST.8231		RO	50	▼	ER-40	-	100	4000	110
99.ST.8232		RO	60	▼	ER-50	-	160	3200	135
99.ST.8233		RO	30	▼	ER-25	• 25bar	32	6000	85
99.ST.8234		RO	40	▼	ER-32	• 25bar	63	5000	100
99.ST.8235		RO	50	▼	ER-40	• 25bar	100	4000	110
99.ST.8236		RO	60	▼	ER-50	• 25bar	160	3200	135
99.ST.8237		RO	30	▼	ER-16	-	8	20000 (1:4)	95
99.ST.8238		RO	40	▼	ER-20	-	16	16000 (1:4)	125



Code		Orient	VDI	Rotation	Output	Int Cool.	Nm	Rpm	H
99.ST.8239	DIN 5482	RO	50	▼	ER-20	-	25	16000 (1:4)	135
99.ST.8240		RD	30	▼	ER-25	-	63	2500	55
99.ST.8241		RD	40	▼	ER-32	-	63	2000 (2:1)	100
99.ST.8242		RD	30	▼	* PF-Ø22	-	63	2500 (2:1)	55
99.ST.8243		RD	40	▼	* PF-Ø22	-	63	2000	100
99.ST.8244		RO	30	▼	* PF-Ø22	-	32	2500	85
99.ST.8245		RO	40	▼	* PF-Ø22	-	63	4000	100
99.ST.8248		UN ±90°	30	▼	ER-20	-	15	6000	64
99.ST.8249		UN ±90°	30	▼	ER-20	-	15	6000	97
99.ST.8250		UN ±90°	40	▼	ER-25	-	25	5000	81
99.ST.8251		UN ±90°	50	▼	ER-25	-	25	4000	100
99.ST.8254		UN ±90°	30	▼	ER-20	● 25bar	15	6000	97
99.ST.8255		UN ±90°	40	▼	ER-25	● 25bar	25	5000	81

- * PF Portafresa - Shell end milling cutter
- Refrigerante Interno - Internal Coolant
- (C) (▼) Disponibile variante con senso di rotazione uguale al mandrino
Available type with direction of rotation same as machine spindle
- ▼ Senso di rotazione opposto al mandrino
Direction of rotation opposite of machine spindle
- ▼ Senso di rotazione uguale al mandrino
Direction of rotation same as machine spindle

LATHE MODELS COMPATIBLES:



- VDI 20
- VDI 30
- VDI 40
- VDI 50



AX
Assiale
Axial

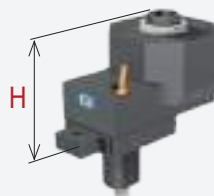

Off-AX
Assiale disassato
Off-set axis



RD
Radiale
Radial

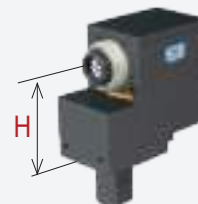

RO
Arretrato
Rear Off-set

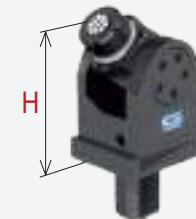

UN
Regolabile ±90°
±90° Adjustable

LATHE MODELS COMPATIBLES:

BARUFFALDI

- VDI 20
- VDI 30
- VDI 40
- VDI 50
- VDI 60

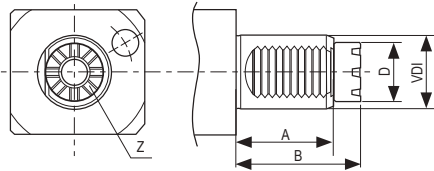

VDI	A	B	D
20	35	41	19
30	45/53	59	24
40	53	68	32
50	70	84	40
60	83	100	43



Presa di Moto - Coupling

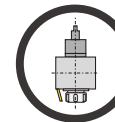

AX

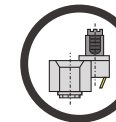

Off AX

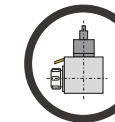

RD

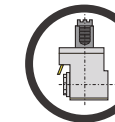

RO

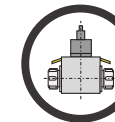

RD-2U

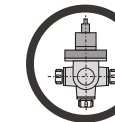

UN

Code		Orient	VDI	Rotation	Output	Int. Cool.	Nm	Rpm	H
99.BF.0001	BARUFFALDI	AX	20	▼	ER-20	-	13	6000	90
99.BF.0002		AX	20	▼	ER-20	-	13	6000	65
99.BF.0003		AX	30	▼	ER-25	-	32	6000	94
99.BF.0005		AX	40	▼	ER-32	-	63	5000	117
99.BF.0007		AX	50	▼	ER-40	-	100	4000	120
99.BF.0009		AX	60	▼	ER-50	-	160	3200	170
99.BF.0010		AX	30	▼	ER-25	• 25bar	32	6000	94
99.BF.0011		AX	40	▼	ER-32	• 25bar	63	5000	115
99.BF.0013		AX	50	▼	ER-40	• 25bar	100	4000	120
99.BF.0014		AX	60	▼	ER-50	• 25bar	160	3200	170
99.BF.0015		AX	20	▼	ER-16	-	3	24.000 (1:4)	100
99.BF.0016		AX	30	▼	ER-16	-	8	20.000 (1:4)	100
99.BF.0017		AX	40	▼	ER-20	-	16	16.000 (1:4)	112,5
99.BF.0018		AX	30	▼	* PF-Ø22	-	32	5000	112
99.BF.0019		AX	40	▼	* PF-Ø22	-	63	4000	124
99.BF.0020		RD	20	▼	ER-20	-	13	6000	60
99.BF.0021		RD	30	▼	ER-25	-	32	6000	55
99.BF.0022		RD	30	▼	ER-25	-	32	6000	85
99.BF.0023		RD	30	▼	ER-25	-	32	6000	100
99.BF.0024		RD	40	▼	ER-32	-	63	5000	100
99.BF.0025		RD	50	▼	ER-40	-	100	4000	110

Code		Orient	VDI	Rotation	Output	Int. Cool.	Nm	Rpm	H
99.BF.0026	BARUFFALDI	RD	60	▼	ER-50	-	160	3200	130
99.BF.0027		RD	30	▼	ER-25	• 25bar	32	6000	55
99.BF.0028		RD	30	▼	ER-25	• 25bar	32	6000	85
99.BF.0029		RD	30	▼	ER-25	• 25bar	32	6000	100
99.BF.0030		RD	40	▼	ER-32	• 25bar	63	5000	100
99.BF.0031		RD	50	▼	ER-40	• 25bar	100	4000	110
99.BF.0032		RD	60	▼	ER-50	• 25bar	160	3200	130
99.BF.0033		RO	20	▼	ER-16	-	13	6000	75
99.BF.0034		RO	30	▼	ER-25	-	32	5000	85
99.BF.0035		RO	40	▼	ER-32	-	63	4000	100
99.BF.0036		RO	50	▼	ER-40	-	100	4000	110
99.BF.0037		RO	30	▼	ER-25	• 25bar	32	5000	85
99.BF.0038		RO	40	▼	ER-32	• 25bar	63	4000	100
99.BF.0039		RO	50	▼	ER-40	• 25bar	100	4000	110
99.BF.0040		RO	20	▼	ER-16	-	3	24000 (1:4)	75
99.BF.0041		RO	30	▼	ER-16	-	8	20000 (1:4)	95
99.BF.0042		RO	40	▼	ER-20	-	16	16000 (1:4)	125
99.BF.0043		RD	30	▼	ER-25	-	63	2500	55
99.BF.0044		RD	40	▼	ER-32	-	63	2000	100
99.BF.0045		RO	30	▼	* PF-Ø22	-	63	2500	55
99.BF.0046		RO	40	▼	* PF-Ø22	-	63	2000	100
99.BF.0047		RO	30	▼	* PF-Ø22	-	32	2500	85

Code	Orient	VDI	Rotation	Output	Int Cool.	Nm	Rpm	H
99.BF.0051	UN ±90°	30	▼	ER-20	-	15	6000	64
99.BF.0052	UN ±90°	30	▼	ER-20	-	15	6000	97
99.BF.0053	UN ±90°	40	▼	ER-25	-	25	5000	81
99.BF.0054	UN ±90°	30	▼	ER-20	● 25bar	15	6000	64
99.BF.0055	UN ±90°	30	▼	ER-20	● 25bar	15	6000	97
99.BF.0056	UN ±90°	40	▼	ER-25	● 25bar	25	5000	81
99.BF.0057	RD	30	▼	ER-25	-	32	6000	55
99.BF.0058	RD	30	▼	ER-25	-	32	6000	85

Code	Orient	VDI	Rotation	Output	Int Cool.	Nm	Rpm	H
99.BF.0059	RD	30	▼	ER-25	-	32	6000	100
99.BF.0060	RD	50	▼	ER-40	-	100	4000	110
99.BF.0061	RD	30	▼	ER-25	● 25bar	32	6000	55
99.BF.0062	RD	30	▼	ER-25	● 25bar	32	6000	85
99.BF.0063	RD	30	▼	ER-25	● 25bar	32	6000	100
99.BF.0064	RD	50	▼	ER-40	● 25bar	100	4000	110
99.BF.0067	RD 2U	30	▼ ▼	ER-25	-	32	6000	110
99.BF.0068	RD 2U	50	▼ ▼	ER-40	-	100	4000	140



- * PF Portafresa - Shell end milling cutter
- Refrigerante Interno - Internal Coolant
- (C) (▼) Disponibile variante con senso di rotazione uguale al mandrino
Available type with direction of rotation same as machine spindle
- ▼ Senso di rotazione opposto al mandrino
Direction of rotation opposite of machine spindle
- ▼ Senso di rotazione uguale al mandrino
Direction of rotation same as machine spindle

LATHE MODELS COMPATIBLES:



- VDI 20
- VDI 30
- VDI 40
- VDI 50
- VDI 60

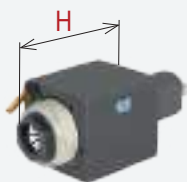

AX
Assiale
Axial

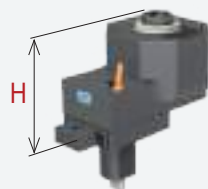

Off-AX
Assiale disassato
Off-set axis

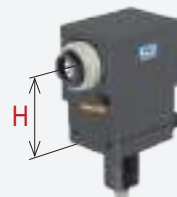

RD
Radiale
Radial

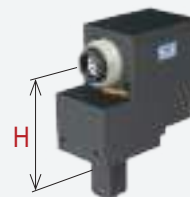

RO
Arretrato
Rear Off-set

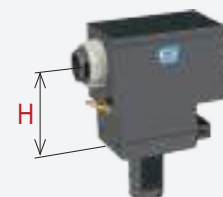

RD - 2U
Radiale Doppia uscita
Radial double output

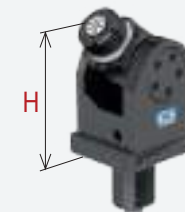

UN
Regolabile ±90°
±90° Adjustable

LATHE MODELS COMPATIBLES:

DIN 1809

- VDI 20
- VDI 25
- VDI 30
- VDI 40
- VDI 50
- VDI 60

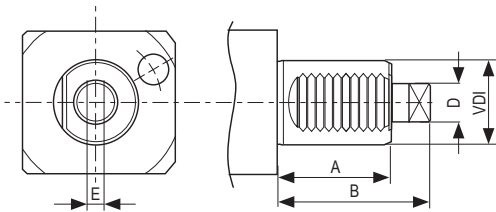

VDI	A	B	D	E
20	35	48	10	5
30	45	62	12	6
40	53	72	18	8
50	78	92	24	13
60	83	110	29	14



Presa di Moto - Coupling

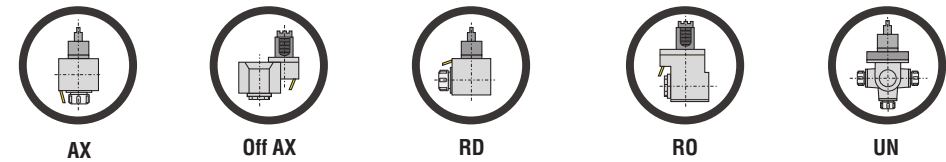

Code	Orient	VDI	Rotation	Output	Int. Cool.	Nm	Rpm	H
99.DP.0901	AX	20	▼	ER-20	-	13	6000	65
99.DP.0902	AX	20	▼	ER-20	-	13	6000	90
99.DP.0903	AX	30	▼	ER-25	-	32	6000	94
99.DP.0904	AX	30	▼	ER-25	-	32	6000	66
99.DP.0905	AX	40	▼	ER-32	-	63	5000	115
99.DP.0907	AX	50	▼	ER-40	-	100	4000	120
99.DP.0908	AX	50	▼	ER-40	-	100	4000	88
99.DP.0909	AX	60	▼	ER-50	-	160	3200	170
99.DP.0910	AX	30	▼	ER-25	• 25bar	32	6000	94
99.DP.0911	AX	40	▼	ER-32	• 25bar	63	5000	115
99.DP.0913	AX	50	▼	ER-40	• 25bar	100	4000	120
99.DP.0914	AX	60	▼	ER-50	• 25bar	160	3200	170
99.DP.0915	AX	20	▼	ER-16	-	3	24.000 (1:4)	100
99.DP.0916	AX	30	▼	ER-16	-	8	20.000 (1:4)	100

Code	Orient	VDI	Rotation	Output	Int. Cool.	Nm	Rpm	H
99.DP.0918	RD	20	▼	ER-20	-	13	6000	60
99.DP.0919	RD	30	▼	ER-25	-	32	6000	55
99.DP.0920	RD	30	▼	ER-25	-	32	6000	85
99.DP.0921	RD	30	▼	ER-25	-	32	6000	100
99.DP.0922	RD	40	▼	ER-32	-	63	5000	100
99.DP.0923	RD	50	▼	ER-40	-	100	4000	110
99.DP.0924	RD	60	▼	ER-50	-	160	3200	130
99.DP.0925	RD	30	▼	ER-25	• 25bar	32	6000	55
99.DP.0926	RD	30	▼	ER-25	• 25bar	32	6000	85
99.DP.0927	RD	30	▼	ER-25	• 25bar	32	6000	100
99.DP.0928	RD	40	▼	ER-32	• 25bar	63	5000	100
99.DP.0929	RD	50	▼	ER-40	• 25bar	100	4000	110
99.DP.0930	RD	60	▼	ER-50	• 25bar	160	3200	130
99.DP.0931	RO	20	▼	ER-16	-	13	6000	75

Code		Orient	VDI	Rotation	Output	Int. Coolant	Nm	Rpm	H
99.DP.0932	DIN 1809	RO	30	▼	ER-25	-	32	5000	85
99.DP.0933		RO	40	▼	ER-32	-	63	4000	100
99.DP.0934		RO	50	▼	ER-40	-	100	4000	110
99.DP.0935		RO	30	▼	ER-25	● 25bar	32	5000	85
99.DP.0936		RO	40	▼	ER-32	● 25bar	63	4000	100
99.DP.0937		RO	50	▼	ER-40	● 25bar	100	4000	110
99.DP.0940		UN	30	▼	ER-20	-	15	6000	64
99.DP.0941		UN	30	▼	ER-20	-	15	6000	97
99.DP.0942		UN	40	▼	ER-25	-	25	5000	81
99.DP.0943		UN	30	▼	ER-20	● 25bar	15	6000	64
99.DP.0944		UN	30	▼	ER-20	● 25bar	15	6000	97
99.DP.0945		UN	40	▼	ER-25	● 25bar	25	5000	81

- * PF Portafresa - Shell end milling cutter
- Refrigerante Interno - Internal Coolant
- (C) (▼) Disponibile variante con senso di rotazione uguale al mandrino
Available type with direction of rotation same as machine spindle
- ▼ Senso di rotazione opposto al mandrino
Direction of rotation opposite of machine spindle
 - ▼ Senso di rotazione uguale al mandrino
Direction of rotation same as machine spindle

LATHE MODELS COMPATIBLES:

DIN 1809

- VDI 20
- VDI 25
- VDI 30
- VDI 40
- VDI 50
- VDI 60



AX
Assiale
Axial

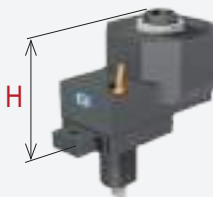

Off-AX
Assiale disassato
Off-set axis

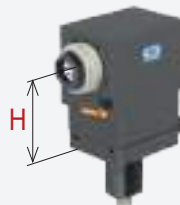

RD
Radiale
Radial

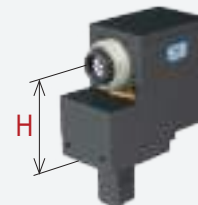

RO
Arretrato
Rear Off-set

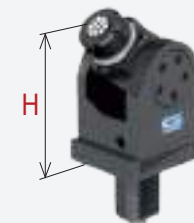

UN
Regolabile ±90°
Adjustable

LATHE MODELS COMPATIBLES:

BMT 40 - B436

BMT 55 - B501-Y / B301 / B470 B455 / B510 / B550 / B650 / B658 / 1200

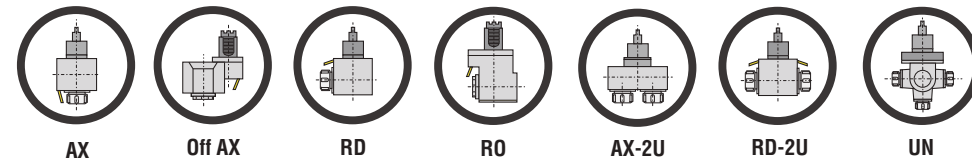
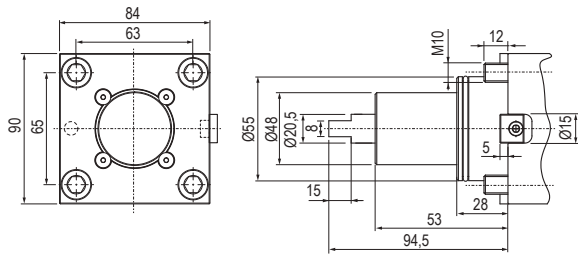

Code		Orient	Rotation	Output	Int. Coolant	Nm	Rpm	H
99.BG.B40	BMT 40	AX	-	ER-20	-	-	6000	57
99.BG.B41		AX	-	ER-20	• 15bar	-	6000	57
99.BG.B42		AX	-	ER-25	-	-	6000	57
99.BG.B43		AX	-	ER-25	• 15bar	-	6000	57
99.BG.B44		AX	-	* PF-16	-	-	6000	61
99.BG.B45		RD	-	ER-20	-	-	6000	45
99.BG.B46		RD	-	ER-20	-	-	6000	70
99.BG.B47		RD	-	ER-20	• 15bar	-	6000	45
99.BG.B48		RD	-	ER-20	• 15bar	-	6000	70
99.BG.B49		RD	-	ER-25	-	-	6000	45
99.BG.B50		RD	-	ER-25	-	-	6000	70
99.BG.B51		RD	-	ER-25	• 15bar	-	6000	45
99.BG.B52		RD	-	ER-25	• 15bar	-	6000	70
99.BG.B53		RD	-	* PF-16	-	-	6000	45
99.BG.B54		RD	-	* PF-16	• 15bar	-	6000	70
99.BG.B55		UN 0-180°	-	ER-11	-	-	6000	91,5
99.BG.B56	UN 0-180°	-	ER-16	-	-	6000	105	

Code		Orient	Rotation	Output	Int. Coolant	Nm	Rpm	H
99.BG.B01.A	BMT 55	AX	▼	ER-25	-	-	4000	63,5
99.BG.B01.B		AX	▼	ER-25	-	-	4000	75
99.BG.B01.C		AX	▼	ER-25	-	-	4000	53,5
99.BG.B01.D		AX	▼	ER-25	• 20bar	-	4000	63,5
99.BG.B01.E		AX	▼	ER-25	• 20bar	-	4000	75
99.BG.B02.A		AX	▼	ER-32	-	-	4000	83,5
99.BG.B02.B		AX	▼	ER-32	-	-	4000	71,5
99.BG.B02.C		AX	▼	ER-32	-	-	4000	59
99.BG.B02.D		AX	▼	ER-32	• 20bar	-	4000	83,5
99.BG.B02.E		AX	▼	ER-32	• 20bar	-	4000	71,5
99.BG.B04.A		RD	▼	ER-25	-	47	4000	70
99.BG.B04.B		RD	▼	ER-25	• 20bar	47	4000	70
99.BG.B04.C		RD	▼	ER-25	-	47	4000	100
99.BG.B04.D		RD	▼	ER-25	• 20bar	47	4000	100
99.BG.B04.E		RD	▼	ER-25	-	47	8000 (1:2)	70
99.BG.B04.F		RD	▼	ER-25	-	47	2000 (2:1)	70
99.BG.B05.A	RD	▼	ER-32	-	47	4000	70	
99.BG.B05.B	RD	▼	ER-32	• 20bar	47	4000	70	
99.BG.B05.C	RD	▼	ER-32	-	47	4000	100	
99.BG.B05.D	RD	▼	ER-32	• 20bar	47	4000	100	

Code		Orient	Rotation	Output	Int. Coolant	Nm	Rpm	H
99.BG.B06.A	BMT 55	AX 2U	▼	ER-16-16	-	-	4000	84
99.BG.B06.B		AX 2U	▼	ER-20-20	-	-	4000	87
99.BG.B06.C		AX 2U	▼	ER-25-25	-	-	4000	88
99.BG.B07.A		RD 2U	▼▼	ER-32-25	-	47	4000	70
99.BG.B07.B		RD 2U	▼▼	ER-32-25	-	47	4000	100
99.BG.B08.A		RD 2U	▼▼	ER-25-25	-	47	4000	70
99.BG.B08.B		RD 2U	▼▼	ER-25-25	-	47	4000	100
99.BG.B09.A		RD 2U	▼▼	ER-25-16	-	47	4000	70
99.BG.B09.B		RD 2U	▼▼	ER-25-16	-	47	4000	100
99.BG.B10		UN 0-90°	▼	ER-20	-	-	4000	140
99.BG.B11		UN 0-180°	▼	ER-16	-	-	4000	111
99.BG.B12		UN	▼	ER-20	-	-	4000	87
99.BG.B14		Off AX	▼	ER-25	-	-	8000 (1:2)	92,5
99.BG.B14.A		Off AX	▼	ER-16	-	-	8000 (1:2)	75
99.BG.B14.B		Off AX	▼	ER-16	● 20bar	-	8000 (1:2)	85
99.BG.B15.A	AX	▼	* PF-Ø16	-	-	4000	86,5	
99.BG.B15.B	AX	▼	* PF-Ø22	-	-	4000	92	
99.BG.B15.C	AX	▼	* PF-Ø27	-	-	4000	94	
99.BG.B15.D	AX	▼	* PF-Ø10	-	-	4000	94,5	
99.BG.B15.E	AX	▼	* PF-Ø13	-	-	4000	94,5	

Code		Orient	Rotation	Output	Int. Coolant	Nm	Rpm	H
99.BG.B15.F	BMT 55	AX	▼	* PF-Ø10	-	-	4000	82,5
99.BG.B15.G		AX	▼	* PF-Ø13	-	-	4000	82,5
99.BG.B16.A		AX	▼	* PF-Ø16	● 20bar	-	4000	76,5
99.BG.B16.B		AX	▼	* PF-Ø22	● 20bar	-	4000	80
99.BG.B17.A		RD	▼	* PF-Ø16	-	47	4000	70
99.BG.B17.B		RD	▼	* PF-Ø16	-	47	4000	100
99.BG.B17.C		RD	▼	* PF-Ø22	-	47	4000	70
99.BG.B17.D		RD	▼	* PF-Ø22	-	47	4000	100
99.BG.B17.E		RD	▼	* PF-Ø27	-	47	4000	70
99.BG.B17.F		RD	▼	* PF-Ø27	-	47	4000	100
99.BG.B17.G		RD	▼	* PF-Ø16	-	-	2000 (2:1)	70
99.BG.B17.H		RD	▼	* PF-Ø22	-	-	2000 (2:1)	70
99.BG.B17.I		RD	▼	* PF-Ø27	-	-	2000 (2:1)	70
99.BG.B17.L		RD	▼	* PF-Ø10	-	-	4000	70
99.BG.B17.M		RD	▼	* PF-Ø13	-	-	4000	70
99.BG.B17.N	RD	▼	* PF-Ø10	-	-	4000	100	
99.BG.B17.O	RD	▼	* PF-Ø13	-	-	4000	100	
99.BG.B19.A	AX	▼	WE-25	● 20bar	-	4000	73	
99.BG.B19.B	AX	▼	WE-20	● 20bar	-	4000	68	
99.BG.B19.C	AX	▼	WE-16	● 20bar	-	4000	61	



LATHE MODELS COMPATIBLES:



- B436



- B501-Y / B301 / B470 B455 / B510 / B550 / B650 / B658 / 1200

- * PF Portafresa - Shell end milling cutter
- Refrigerante Interno - Internal Coolant
- (C) (▼) Disponibile variante con senso di rotazione uguale al mandrino
Available type with direction of rotation same as machine spindle
- ▼ Senso di rotazione opposto al mandrino
Direction of rotation opposite of machine spindle
- ▼ Senso di rotazione uguale al mandrino
Direction of rotation same as machine spindle

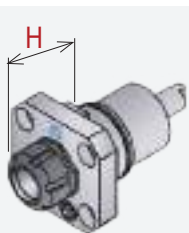

AX
Assiale
Axial

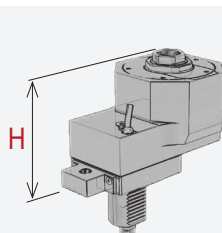

Off-AX
Assiale disassato
Off-set axis

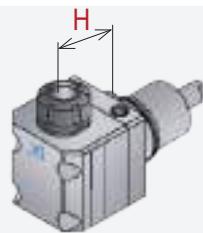

RD
Radiale
Radial

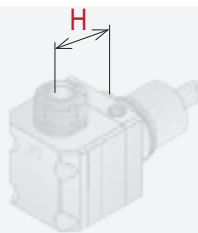

RO
Arretrato
Rear Off-set

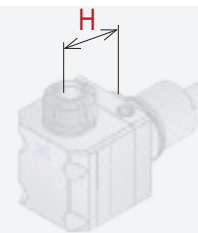

AX - 2U
Assiale doppia uscita
Axial double output

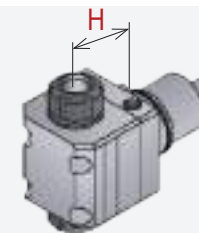

RD - 2U
Radiale Doppia uscita
Radial double output



UN
Regolabile ±90°
Adjustable

LATHE MODELS COMPATIBLES:

- NL**
- NL / NLX 1500 / 2000 / 2500 / 3000 12 station turret
 - NLX 4000
 - NT 4000 / 4200 / 4250 / 4300 / 5000 / 5400
 - NZL 2000 / 2500
 - NZX 2500 - 12 station

- NZ**
- DuraTurn 2050 / 2550 MC
 - NL / NLX 1500 / 2000 / 2500 20 station turret
 - NT / NTX 1000 / 2000
 - NT 3000 / 3100 / 3150 / 3200
 - NZ / NZX 1500 / 2000
 - NZ / NZX 2500 16 station turret

- SL
ZL
DL**
- SL / ZL 150 / 153 / 154
 - DL 150
 - ZL/DL 200/250 (MC)
 - SL 200 / 203 / 204 / 250 / 253 / 254 (MC, SMC) - 2500Y

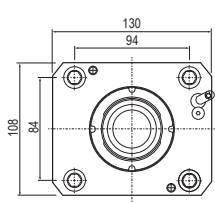

NLX attachment

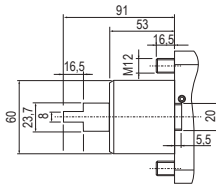

NZ attachment

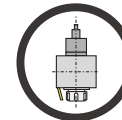
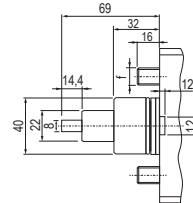
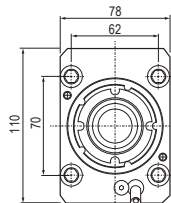

AX

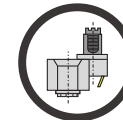

Off AX

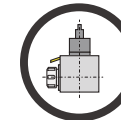

RD

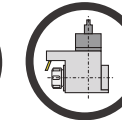

RUD

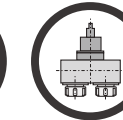

AX-2U

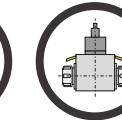

RD-2U

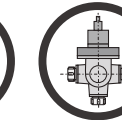

UN

Code		Orient	Rotation	Output	Int. Coolant	Nm	Rpm	H
99.MS.A57	NLX	AX-2U	▼	ER-25-25	-	40	6000	113,8÷117,5
99.MS.A58		AX-2U	▼	ER-25-25	• 80bar	40	6000	113,8÷117,5
99.MS.A59		AX	▼	ER-32	-	60	10.000	86,2÷89,9
99.MS.A62		AX	▼	ER-40	-	60	10.000	88,3÷92
99.MS.A60		AX	▼	ER-32	• 80bar	60	10.000	86,2÷89,9
99.MS.A63		AX	▼	ER-40	• 80bar	60	10.000	88,3÷92
99.MS.A01		AX	▼	WELDON Ø20	-	60	10.000	95
99.MS.A02		AX	▼	WELDON Ø20	• 80bar	60	10.000	95
99.MS.A03		AX	▼	WELDON Ø25	-	60	10.000	125,1
99.MS.A04		AX	▼	WELDON Ø25	• 80bar	60	10.000	125,1
99.MS.A05		AX	▼	WELDON Ø1"	-	60	10.000	125
99.MS.A06		AX	▼	WELDON Ø1"	• 80bar	60	10.000	125
99.MS.A07		RD	▼	WELDON Ø20	-	60	10.000	90
99.MS.A08		RD	▼	WELDON Ø20	• 80bar	60	10.000	90

Code		Orient	Rotation	Output	Int. Coolant	Nm	Rpm	H
99.MS.A09	NLX	RD	▼	WELDON Ø25	-	60	10.000	90
99.MS.A10		RD	▼	WELDON Ø25	• 80bar	60	10.000	90
99.MS.A11		RD	▼	WELDON Ø1"	-	60	10.000	90
99.MS.A12		RD	▼	WELDON Ø1"	• 80bar	60	10.000	90
99.MS.A72		RD	▼	ER-32	-	60	10.000	90
99.MS.A76		RD	▼	ER-40	-	60	10.000	90
99.MS.A73		RD	▼	ER-32	• 80bar	60	10.000	90
99.MS.A82		RD	▼	ER-25	-	60	10.000	90
99.MS.A83		RD	▼	ER-25	• 80bar	60	10.000	90
99.MS.A74		RO	▼	ER-32	-	60	10.000	100
99.MS.A75		RO	▼	ER-32	-	60	10.000	100
99.MS.A77		RD	▼	ER-40	• 80bar	60	10.000	90
99.MS.A86		UN	▼	ER-25	-	25	10.000	78
99.MS.A87		UN	▼	ER-25	• 80bar	25	10.000	78

Code		Orient	Rotation	Output	Int. Coolant	Nm	Rpm	H
99.MS.A101	NZ	AX	▼	ER-25	-	50	12.000	80,6÷84,3
99.MS.A103		AX	▼	ER-32	-	50	12.000	85,5÷89,2
99.MS.A102		AX	▼	ER-25	● 100bar	50	12.000	80,6÷84,3
99.MS.A104		AX	▼	ER-32	● 100bar	50	12.000	85,5÷89,2
99.MS.A105		AX	▼	* PF-Ø22	-	50	12.000	100
99.MS.A108		RD	▼	ER-32	-	50	12.000	85
99.MS.A109		RD	▼	ER-32	● 100bar	50	12.000	85
99.MS.A106		RD	▼	ER-25	-	50	12.000	85
99.MS.A107		RD	▼	ER-25	● 100bar	50	12.000	85
99.MS.A110		RD	▼	* PF-Ø22	-	50	12.000	85
99.MS.A115		RD 2U	▼▼	ER-25-25	-	50	12.000	85
99.MS.A114		RD 2U	▼▼	ER-32-32	-	50	12.000	85
99.MS.A118		UN ±90°	▼	ER-20	-	17	12.000	50
99.MS.A119		UN ±90°	▼	ER-20	● 100bar	17	12.000	50

Code		Orient	Rotation	Output	Int. Coolant	Nm	Rpm	H
99.MS.A28	SL ZL DL	AX	▼	ER-30	-	70	6000	55,5÷60
99.MS.A29		AX	▼	ER-32	● 80bar	70	6000	55,5÷60
99.MS.A80		AX	▼	ER-25	-	60	10.000	81,3÷85
99.MS.A81		AX	▼	ER-25	● 80bar	60	10.000	81,3÷85
99.MS.A33		RD	▼	ER-32	-	70	6000	55
99.MS.A34		RD	▼	ER-32	● 80bar	70	6000	55
99.MS.A35		RD	▼	ER-16	-	8	24.000 (1:4)	55
99.MS.A41		RUD	▼	ER-32	-	70	6.000	55
99.MS.A42		RUD	▼	ER-32	● 80bar	70	6.000	55
99.MS.A43		RUD	▼	ER-16	-	8	24.000 (1:4)	55
99.MS.A49		RD 2U	▼▼	ER-32-32	-	70	6.000	55
99.MS.A51		RD 2U	▼▼	ER-16-16	-	8	24.000 (1:4)	55
99.MS.A55		UN ±90°	▼	ER-20	-	25	6.000	66
99.MS.A56		UN ±90°	▼	ER-20	● 80bar	25	6.000	66



- * PF Portafresa - Shell end milling cutter
- Refrigerante Interno - Internal Coolant
- (C) (▼) Disponibile variante con senso di rotazione uguale al mandrino
Available type with direction of rotation same as machine spindle
- ▼ Senso di rotazione opposto al mandrino
Direction of rotation opposite of machine spindle
- ▼ Senso di rotazione uguale al mandrino
Direction of rotation same as machine spindle

LATHE MODELS COMPATIBLES:

NL - NL / NLX 1500 / 2000 / 2500 / 3000 12 station turret
- NLX 4000
- NT 4000 / 4200 / 4250 / 4300 / 5000 / 5400
- NZL 2000 / 2500
- NZX 2500 - 12 station

NZ - DuraTurn 2050 / 2550 MC
- NL / NLX 1500 / 2000 / 2500 20 station turret
- NT / NTX 1000 / 2000
- NT 3000 / 3100 / 3150 / 3200
- NZ / NZX 1500 / 2000
- NZ / NZX 2500 16 station turret

SL ZL DL - SL / ZL 150 / 153 / 154
- DL 150
- ZL/DL 200/250 (MC)
- SL 200 / 203 / 204 / 250 / 253 / 254 (MC, SMC) - 2500Y

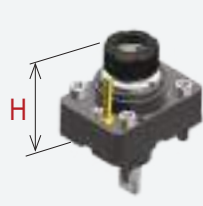

AX
Assiale
Axial

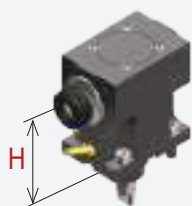

RD
Radiale
Radial

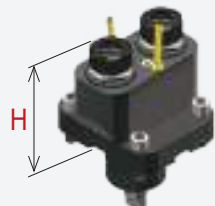

AX - 2U
Assiale doppia uscita
Axial double output

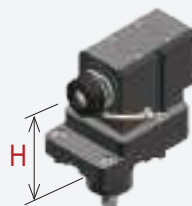

RO
Arretrato
Rear Off-set

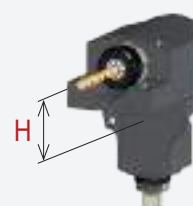

RUD
Radiale rovesciato
Radial upside-down

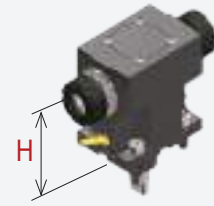

RD - 2U
Radiale doppia uscita
Radial double output

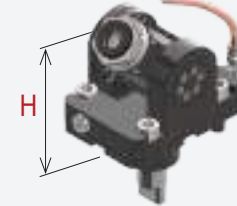

UN
Regolabile ±90°
±90° Adjustable

COMPATIBLES FOR ALL LATHES
WITH STANDARD BMT TURRET :

BMT 45	BMT 55	BMT 65	BMT 75	BMT 85
--------	--------	--------	--------	--------

BMT	c1	d	d1	d2	f1	f2	f3
45	15	45	35	14	58	58	10
55	15	55	40	16	64	64	14
65	18	65	45	18	70	70	15
75	25	75	55	23	90	90	15
85	25	85	65	33,5	100	100	18

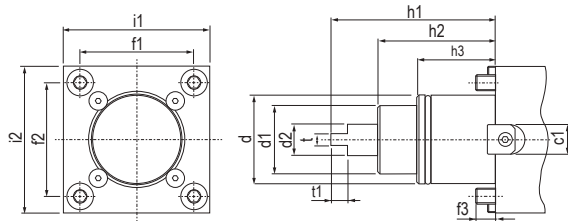

BMT	h1	h2	h3	i1	i2	t	t2
45	84	60	40	75	75	6	8,5
55	104	75	30	85	85	8	8,5
65	112	83	32	94	94	10	14
75	110	80	43	112	112	14	15
85	140	100	43	125	125	16	20

Code		Orient	Rotation	Output	Int. Coolant	Nm	Rpm	H
99.DS.A03	BMT45	AX	▼	ER-25	-	35	8000	Max 57,2
99.DS.A04		AX	▼	ER-25	• 80bar	35	8000	Max 57,2
99.DS.A05		AX	▼	ER-16	-	12	32.000 (1:4)	Max 86,5
99.DS.A83		AX	▼	ER-32	-	35	8000	76,5÷80,2
99.DS.A84		AX	▼	ER-32	• 80bar	35	8000	76,5÷80,2
99.DS.A06		Off-AX	▼	ER-16	-	15	16.000 (1:2)	70,5
99.DS.A07 (C)		RD	▼ (▼)	ER-25	-	35	8000	65
99.DS.A08 (C)		RD	▼ (▼)	ER-25	• 80bar	35	8000	65
99.DS.A09		RD	▼	ER-16	-	12	32.000 (1:4)	65
99.DS.A10		RD	▼	ER-16	-	15	16.000 (1:2)	65
99.DS.A67 (C)		RD	▼ (▼)	ER-25	• 80bar	35	8000	85
99.DS.A68 (C)		RD	▼ (▼)	ER-25	• 80bar	35	8000	100
99.DS.A87 (C)		RD	▼ (▼)	ER-32	-	35	8000	65
99.DS.A88 (C)		RD	▼ (▼)	ER-32	• 80bar	35	8000	65
99.DS.A97 (C)		RD	▼ (▼)	ER-25	-	35	8000	85
99.DS.A98 (C)		RD	▼ (▼)	ER-25	-	35	8000	100
99.DS.A13		RD 2U	▼ ▼	ER-25-25	-	35	8000	65
99.DS.A16		UN ±90°	▼	ER-20	-	15	8000	65
99.DS.A17		UN ±90°	▼	ER-20	• 80bar	15	8000	65



Code		Orient	Rotation	Output	Int. Coolant	Nm	Rpm	H
99.DS.A01	BMT55	AX	▼	ER-25	-	40	8000	57,2
99.DS.A02		AX	▼	ER-25	• 80bar	40	8000	57,2
99.DS.A18		AX	▼	ER-16 EF	-	12	32.000 (1:4)	86,5
99.DS.A19		Off AX	▼	ER-16 EF	-	15	16.000 (1:2)	66,8÷70,5
99.DS.A11 (C)		RD	▼ (▼)	ER-25	-	40	8000	70
99.DS.A12 (C)		RD	▼ (▼)	ER-25	• 80bar	40	8000	70
99.DS.A20		RD	▼	ER-16 EF	-	4	24.000 (1:4)	80
99.DS.A21		RD	▼	ER-16 EF	-	15	16.000 (1:2)	80
99.DS.A69 (C)		RD	▼ (▼)	ER-25	-	40	8000	60
99.DS.A70 (C)		RD	▼ (▼)	ER-25	• 80bar	40	8000	60
99.DS.A71 (C)		RD	▼ (▼)	ER-25	-	40	8000	85
99.DS.A72 (C)		RD	▼ (▼)	ER-25	• 80bar	40	8000	85
99.DS.A81 (C)		RD	▼ (▼)	ER-25	-	40	8000	100
99.DS.A82 (C)		RD	▼ (▼)	ER-25	• 80bar	40	8000	100
99.DS.A24		RD 2U	▼ ▼	ER-25-25	-	40	8000	70
99.DS.A94		RD 2U	▼ ▼	ER-25-25	-	40	8000	60
99.DS.A95		RD 2U	▼ ▼	ER-25-25	-	40	8000	85
99.DS.A96		RD 2U	▼ ▼	ER-25-25	-	40	8000	100
99.DS.A23		UN ±90°	▼	ER-20	-	15	8000	65
99.DS.A66		UN ±90°	▼	ER-20	• 80bar	15	8000	65



Code		Orient	Rotation	Output	Int. Coolant	Nm	Rpm	H
99.DS.A41	BMT65	AX	▼	ER-32	-	70	6000	72,2
99.DS.A42		AX	▼	ER-32	● 80bar	70	6000	72,2
99.DS.A27		AX	▼	ER-20	-	8	24.000 (1:4)	122,5÷126,5
99.DS.A51 (C)		RD	▼ (▼)	ER-32	-	70	6000	72
99.DS.A52 (C)		RD	▼ (▼)	ER-32	● 80bar	70	6000	72
99.DS.A29		RD	▼	ER-20	-	8	24.000 (1:4)	72
99.DS.A73 (C)		RD	▼ (▼)	ER-32	-	70	6000	100
99.DS.A74 (C)		RD	▼ (▼)	ER-32	● 80bar	70	6000	100
99.DS.A62 (C)		RD	▼ (▼)	* PF-22	-	70	6000	72
99.DS.A31		RD 2U	▼ (▼)	ER-32-32	-	70	6000	72
99.DS.A78		RD 2U	▼ (▼)	ER-32-32	-	70	6000	100
99.DS.A64		UN ±90°	▼	ER-25	-	25	6000	75
99.DS.A65		UN ±90°	▼	ER-25	● 80bar	25	6000	75
99.DS.A34		BMT75	AX	▼	ER-40	-	100	6000
99.DS.A35	AX		▼	ER-40	● 80bar	100	6000	Max 90,2
99.DS.A38 (C)	RD		▼ (▼)	ER-40	-	100	6000	60
99.DS.A39 (C)	RD		▼ (▼)	ER-40	● 80bar	100	6000	60
99.DS.A55 (C)	RD		▼ (▼)	WELDON 32	● 80bar	100	4000	60

Code		Orient	Rotation	Output	Int. Coolant	Nm	Rpm	H
99.DS.A75 (C)	BMT75	RD	▼ (▼)	ER-40	-	100	6000	90
99.DS.A76 (C)		RD	▼ (▼)	ER-40	● 80bar	100	6000	90
99.DS.A85 (C)		RD	▼ (▼)	ER-40	-	100	6000	110
99.DS.A86 (C)		RD	▼ (▼)	ER-40	● 80bar	100	6000	110
99.DS.A44		RD 2U	▼ (▼)	ER-40-40	-	100	6000	60
99.DS.A79		RD 2U	▼ (▼)	ER-40-40	-	100	6000	90
99.DS.A80		RD 2U	▼ (▼)	ER-40-40	-	100	6000	110
99.DS.A47		UN ±90°	▼	ER-25	-	25	6000	75
99.DS.A48		UN ±90°	▼	ER-25	● 80bar	25	6000	75
99.DS.A50		BMT85	AX	▼	ER-50	● 80bar	150	3200
99.DS.A90	AX		▼	ER-50	-	150	3200	119,2
99.DS.A56 (C)	RD		▼ (▼)	ER-50	● 80bar	150	3200	85
99.DS.A57 (C)	RD		▼ (▼)	ER-50	● 80bar	150	3200	110
99.DS.A77 (C)	RD		▼ (▼)	ER-50	-	150	3200	85
99.DS.A89 (C)	RD		▼ (▼)	ER-50	-	150	3200	110
99.DS.A60	UN ±90°		▼	ER-32	-	50	4000	167,5
99.DS.A61	UN ±90°		▼	ER-32	● 80bar	50	4000	167,5

COMPATIBLES FOR ALL LATHES
WITH STANDARD BMT TURRET :

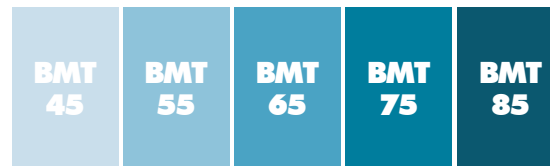

MOST USED BY :

DOOSAN / HARDINGE / SAMSUNG
HWACHEON / HYUNDAI WIA / VICTOR

- * PF Portafresa - Shell end milling cutter
- Refrigerante Interno - Internal Coolant
- (C) (▼) Disponibile variante con senso di rotazione uguale al mandrino
Available type with direction of rotation same as machine spindle
- ▼ Senso di rotazione opposto al mandrino
Direction of rotation opposite of machine spindle
- ▼ Senso di rotazione uguale al mandrino
Direction of rotation same as machine spindle



AX
Assiale
Axial

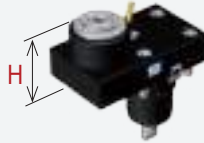

Off-AX
Assiale disassato
Off-set axis



RD
Radiale
Radial



RD - 2U
Radiale doppia uscita
Radial double output



UN
Regolabile ±90°
±90° Adjustable

LATHE MODELS COMPATIBLES:

L = 104.85	VDI Turret: - SL20 - SL30	L = 117.55	- DS30 / SL40 / ST40 (VDI Turret) - DS30 / ST20 / ST30 (VB24 Hybrid Turret) - DS20-30 / SL 20-30-40 / ST 20-30 (VB12 Hybrid Turret)	L = 130.25	- ST40 - (VB12 Hybrid Turret)
-------------------	------------------------------	-------------------	---	-------------------	----------------------------------

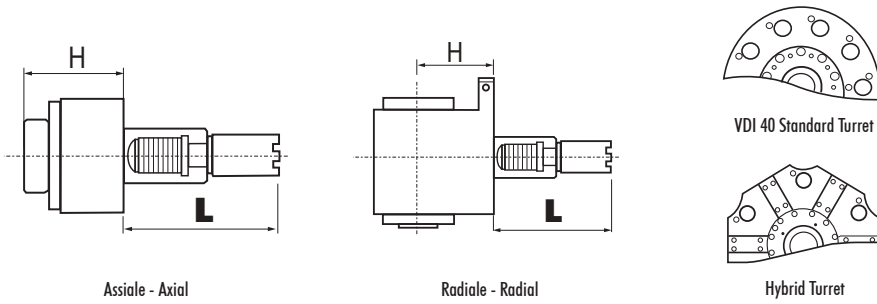

Code		Orient	VDI	Rotation	Output	Int. Coolant	Nm	Rpm	H
99.HA.590083	HAAS - L = 104.85	AX	40	▼	ER-32	-	63	6000	75
99.HA.590083B		AX	40	▼	ER-32	• 25bar	63	6000	75
99.HA.590085		RD	40	▼	ER-32	-	63	6000	75
99.HA.590085B		RD	40	▼	ER-32	• 25bar	63	6000	75
99.HA.00U1		UN ±90°	40	▼	ER-25	-	25	6000	81
99.HA.00U1B		UN ±90°	40	▼	ER-25	• 25bar	25	6000	81

Code		Orient	VDI	Rotation	Output	Int. Coolant	Nm	Rpm	H
99.HA.590082	HAAS - L = 117.55	AX	40	▼	ER-32	-	63	6000	75
99.HA.590082B		AX	40	▼	ER-32	• 25bar	63	6000	75
99.HA.590084		RD	40	▼	ER-32	-	63	6000	75
99.HA.590084B		RD	40	▼	ER-32	• 25bar	63	6000	75
99.HA.00U2		UN ±90°	40	▼	ER-25	-	25	5000	81
99.HA.00U2B		UN ±90°	40	▼	ER-25	• 25bar	25	5000	81



Code		Orient	VDI	Rotation	Output	Int. Coolant	Nm	Rpm	H
99.HA.596352	HAAS - L = 130.25	AX	40	▼	ER-32	-	63	6000	75
99.HA.596352B		AX	40	▼	ER-32	• 25bar	63	6000	75
99.HA.596353		RD	40	▼	ER-32	-	63	6000	75
99.HA.596353B		RD	40	▼	ER-32	• 25bar	63	6000	75
99.HA.00U3		UN ±90°	40	▼	ER-25	-	25	6000	81
99.HA.00U3B		UN ±90°	40	▼	ER-25	• 25bar	25	6000	81

- * PF Portafresa - Shell end milling cutter
- Refrigerante Interno - Internal Coolant
- (C) (▼) Disponibile variante con senso di rotazione uguale al mandrino
Available type with direction of rotation same as machine spindle
- ▼ Senso di rotazione opposto al mandrino
Direction of rotation opposite of machine spindle
- ▼ Senso di rotazione uguale al mandrino
Direction of rotation same as machine spindle

LATHE MODELS COMPATIBLES:

L = 104.85

VDI Turret:
- SL20 - SL30

L = 117.55

- DS30 / SL40 / ST40 (VDI Turret)
- DS30 / ST20 / ST30 (VB24 Hybrid Turret)
- DS20-30 / SL 20-30-40 / ST 20-30 (VB12 Hybrid Turret)

L = 130.25

- ST40
- (VB12 Hybrid Turret)

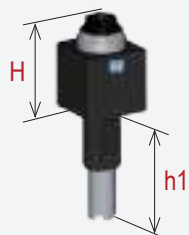

AX
Assiale
Axial

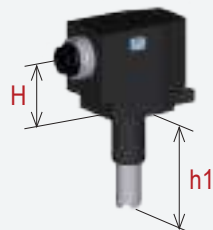

RD
Radiale
Radial

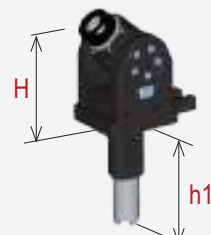

UN
Regolabile ±90°
Adjustable

Interchangeable



VDI 40

PRESE DI MOTO INTERCAMBIABILI PER TORRETTE HAAS
INTERCHANGEABLE COUPLINGS FOR THE DIFFERENT HAAS TURRET

LATHE MODELS COMPATIBLES:

QTN 1	- SQT 10	QTN 2	- QTN 200 / 250	QTN 3	- QTN 300 / 350 / 400 / 450	QTS	- QTS 100M	HQ	- Hyper Quadrex 150 MY- 200 Msy
	- QTN 100 / 150		- SQT 15 / 18		- SQT 28 / 38		- QTS 200M		- MULTIPLEX 610 / 615 / 620 / 625 / 6200 / 6250
	- QTN 200 / 250								
	- SQT 15 / 18								
	- SQT 200 / 250								

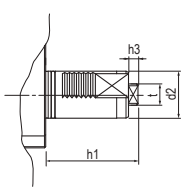

QTN attachment

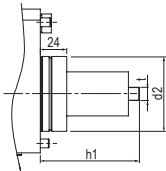

QTS attachment

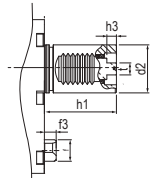

HQ attachment

	d2	h1	h3	t	f	f3
QTN1	Ø40	61	1	10	-	-
QTN2	Ø40	70	8	18	-	-
QTN3	Ø50	75	10	12	-	-
QTS	Ø68	90	-	12	-	-
HQ	Ø40	60	8	10	Ø20	9,8

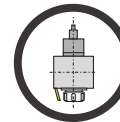

AX

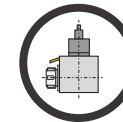

RD

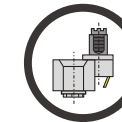

Off AX

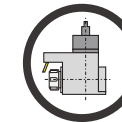

RO

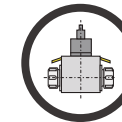

RD-2U

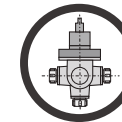

UN

Code		Orient	Rotation	Output	Int. Coolant	Nm	Rpm	H
99.MZ.A40	QTN 1	Off-AX	▼	ER-25	-	50	6000	116,2 ÷ 120
99.MZ.A41		Off-AX	▼	ER-25	• 80bar	63	6000	116,2 ÷ 120
99.MZ.A46		RD	▼	ER-25	-	50	6000	100
99.MZ.A47		RD	▼	ER-25	• 80bar	63	6000	100
99.MZ.A48		RUD	▼	ER-25	-	63	6000	100
99.MZ.A49		RUD	▼	ER-25	• 80bar	63	6000	100
99.MZ.A55		RD 2U	▼ ▼	ER-25-25	-	63	6000	100
99.MZ.A56		UN ±90°	▼	ER-20	-	63	6000	85

Code		Orient	Rotation	Output	Int. Coolant	Nm	Rpm	H
99.MZ.A58	QTN 2	Off-AX	▼	ER-32	-	80	6000	116,2 ÷ 120
99.MZ.A59		Off-AX	▼	ER-32	• 80bar	80	6000	116,2 ÷ 120
99.MZ.A65		RD	▼	ER-32	-	80	6000	130
99.MZ.A66		RD	▼	ER-32	• 80bar	80	6000	130
99.MZ.A67		RUD	▼	ER-32	-	80	6000	130
99.MZ.A68		RUD	▼	ER-32	• 80bar	80	6000	130
99.MZ.A73		RD 2U	▼ ▼	ER-32-32	-	80	6000	130
99.MZ.A74		UN ±90°	▼	ER-25	-	80	6000	85
99.MZ.A64		UN ±90°	▼	ER-25	• 80bar	80	6000	85

Code		Orient	Rotation	Output	Int. Coolant	Nm	Rpm	H
99.MZ.A71	QTN 3	Off-AX	▼	ER-40	-	100	4000	145
99.MZ.A72		Off-AX	▼	ER-40	● 80bar	100	4000	90
99.MZ.A76		Off-AX	▼	ISO-40	-	100	4000	92,5
99.MZ.A79		Off-AX	▼	ISO-40	● 80bar	100	4000	125
99.MZ.A75		RD	▼	ER-40	-	100	4000	160
99.MZ.A81		RD	▼	ER-40	● 80bar	100	4000	160
99.MZ.A77		RD	▼	ISO-40	-	100	4000	160
99.MZ.A78		RD	▼	ISO-40	● 80bar	100	4000	160
99.MZ.A82		RUD	▼	ER40	-	100	4000	160
99.MZ.A83		RUD	▼	ER-40	● 80bar	100	4000	160
99.MZ.A84		RD 2U	▼ ▼	ER-40-40	-	100	4000	160
99.MZ.A80		UN ±90°	▼	ER-32	-	100	4000	85

Code		Orient	Rotation	Output	Int. Coolant	Nm	Rpm	H
99.MZ.A03	QTS	AX	▼	ER-32	-	60	6000	70
99.MZ.A06		AX	▼	ER-32	● 80bar	60	6000	70
99.MZ.A09		RD	▼	ER-32	-	60	6000	80
99.MZ.A10		RD	▼	ER-32	● 80bar	60	6000	80
99.MZ.A13		RD 2U	▼ ▼	ER-32-32	-	70	6000	80
99.MZ.A14	HQ	UN ±90°	▼	ER-25	-	30	6000	80
99.MZ.A15		UN ±90°	▼	ER-25	● 80bar	30	6000	80
99.MZ.A30		Off-AX	▼	ER-25	-	50	6000	116
99.MZ.A31		Off-AX	▼	ER-25	● 80bar	50	6000	116
99.MZ.A36		RD	▼	ER-25	-	50	6000	115
99.MZ.A37	RD	▼	ER-25	● 80bar	50	6000	115	
99.MZ.A35	RD 2U	▼ ▼	ER-25-25	-	50	6000	115	



* PF Portafresa - Shell end milling cutter
 ● Refrigerante Interno - Internal Coolant
 (C) (▼) Disponibile variante con senso di rotazione uguale al mandrino
 Available type with direction of rotation same as machine spindle
 ▼ Senso di rotazione opposto al mandrino
 Direction of rotation opposite of machine spindle
 ▼ Senso di rotazione uguale al mandrino
 Direction of rotation same as machine spindle

LATHE MODELS COMPATIBLES:

QTN 1	- SQT 10 - QTN 100 / 150 - QTN 200 / 250 - SQT 15 / 18 - SQT 200 / 250	QTN 2	- QTN 200 / 250 - SQT 15 / 18 - SQT 200 / 250	QTN 3	- QTN 300 / 350 / 400 / 450 - SQT 28 / 38 - SQT 300	QTS	- QTS 100M - QTS 200M	HQ	- Hyper Quadrex 150 MY- 200 Msy - MULTIPLEX 610 / 615 / 620 / 625 / 6200 / 6250
--------------	--	--------------	---	--------------	---	------------	--------------------------	-----------	--



AX
Assiale
Axial



Off AX
Assiale disassato
Off-set axis



RD
Radiale
Radial



RUD
Radiale rovesciato
Radial upside-down

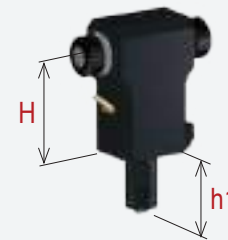

RD - 2U
Radiale doppia uscita
Radial double output

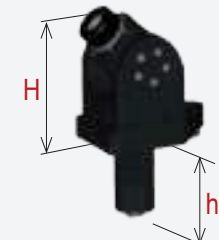

UN
Regolabile ±90°
±90° Adjustable

LATHE MODELS COMPATIBLES:

Ø45	- ABX 51 / 64 - TH2 / TH3 - BNE 32 / 42 - BNU 42 / 51	Ø54	- ABX 51 / 64 - ABX 51 / 64 SY
------------	--	------------	-----------------------------------

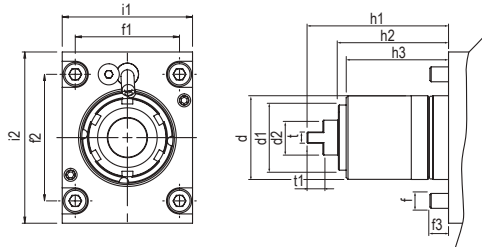

	d	d1	d2	f	f1	f2	f3
Ø45	45	35	19	M8	56	68	10
Ø54	54	-	-	-	75	60	-

	h1	h2	h3	i1	i2	t	t1
Ø45	76	59	55	92	70	t2	8,5
Ø54	72	50	-	90	100	8	-



Code	d	Orient	Rotation	Output	Int. Coolant	Nm	Rpm	H
99.MY.A02	Ø45	AX	▼	ER-25	-	35	6000	53,9+57,6
99.MY.A03		AX	▼	ER-25	• 80bar	35	6000	53,9+57,6
99.MY.A15		AX	▼	ER-32	-	35	6000	60,6+64,3
99.MY.A16		AX	▼	ER-32	• 80bar	35	6000	60,6+64,3
99.MY.A01		AX	▼	ER-16 EF	-	6	24.000 (1:4)	90,8+94,5
99.MY.A14		AX	▼	* PF-Ø16	-	35	6000	68,5
99.MY.A05		RD	▼	ER-25	-	35	6000	65

Code	d	Orient	Rotation	Output	Int. Coolant	Nm	Rpm	H
99.MY.A06	Ø45	RD	▼	ER-25	• 80bar	35	6000	65
99.MY.A04		RD	▼	ER-16	-	6	24.000 (1:4)	65
99.MY.A17		RD	▼	* PF-Ø16	-	35	6000	65
99.MY.A07		RD 2U	▼ ▼	ER-25-25	-	35	6000	65
99.MY.A08		UN ±90°	▼	ER-20	-	15	6000	65
99.MY.A13		UN ±90°	▼	ER-20	• 80bar	15	6000	65



Code		Orient	Rotation	Output	Int. Coolant	Nm	Rpm	H
99.MY.A09	Ø54	AX	▼	ER-32	-	60	6000	75,7÷79,4
99.MY.A10		AX	▼	ER-32	• 80bar	60	6000	75,7÷79,4
99.MY.A11		RD	▼	ER-32	-	60	6000	75
99.MY.A12		RD	▼	ER-32	• 80bar	60	6000	75
99.MY.A18		RD 2U	▼ ▼	ER-32-32	-	60	6000	75
99.MY.A19		UN ±90°	▼	ER-20	-	15	6000	75
99.MY.A20		UN ±90°	▼	ER-20	• 80bar	15	6000	75

- * PF Portafresa - Shell end milling cutter
- Refrigerante Interno - Internal Coolant
- (C) (▼) Disponibile variante con senso di rotazione uguale al mandrino
Available type with direction of rotation same as machine spindle
- ▼ Senso di rotazione opposto al mandrino
Direction of rotation opposite of machine spindle
- ▼ Senso di rotazione uguale al mandrino
Direction of rotation same as machine spindle

LATHE MODELS COMPATIBLES:

Ø45	- ABX 51 / 64	Ø54	- ABX 51 / 64
	- TH2 / TH3		- ABX 51 / 64 SY
	- BNE 32 / 42		
	- BNI 42 / 51		

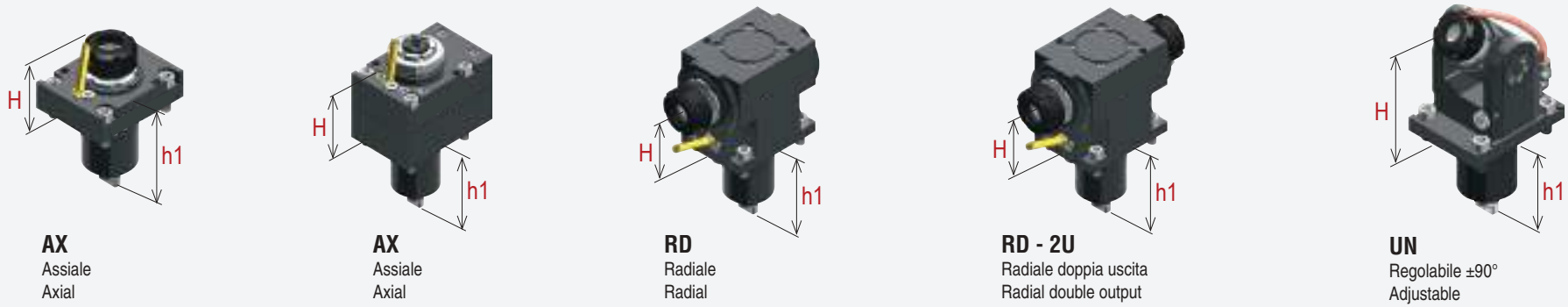

LATHE MODELS COMPATIBLES:

BMT 44	- WT100 - NTY3	BMT 55	- SUPER NTJ / NTJX - NTM3 - TMC18 - TW10 - SC150 - 250 - WT150 - 250 - WTW 150 - WTS 150	BMT 65	- TW20 - SC300 - WT300
---------------	-------------------	---------------	---	---------------	------------------------------

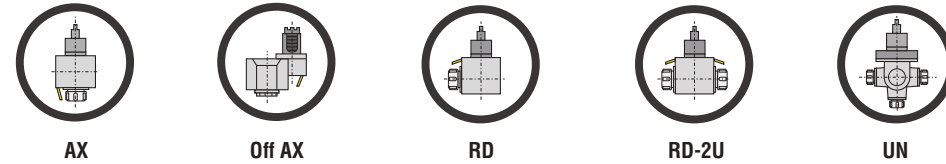
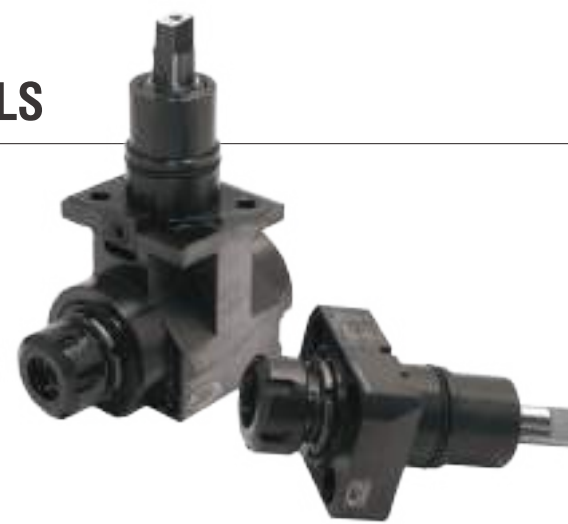
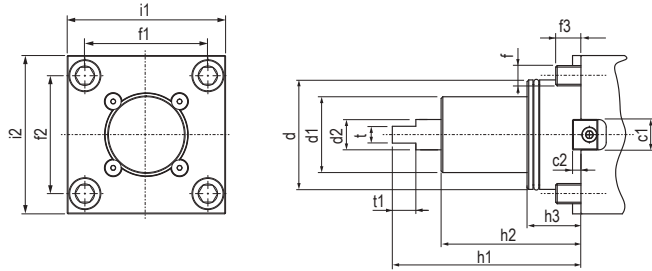

Code		Orient	Rotation	Output	Int. Coolant	Nm	Rpm	H
99.NK.A40	BMT44	AX	▼	ER-25	-	40	6000	53,5÷57,2
99.NK.A43		AX	▼	ER-25	• 70bar	40	6000	53,5÷57,2
99.NK.A50		RD	▼	ER-25	-	40	6000	60
99.NK.A53		RD	▼	ER-25	• 70bar	40	6000	60
99.NK.A30		RD	▼	ER-25	-	40	6000	75
99.NK.A33		RD	▼	ER-25	• 70bar	40	6000	75
99.NK.A70		RD 2U	▼ ▼	ER-25-25	-	40	6000	60
99.NK.A80		RD 2U	▼ ▼	ER-25-25	-	40	6000	75
99.NK.A59		UN ±90°	▼	ER-16	-	10	6000	68,5
99.NK.A69		UN ±90°	▼	ER-16	• 70bar	10	6000	68,5

Code		Orient	Rotation	Output	Int. Coolant	Nm	Rpm	H
99.NK.A03	BMT55	AX	▼	ER-32	-	63	6000	68,5÷72,2
99.NK.A04		AX	▼	ER-32	• 70bar	63	6000	68,5÷72,2
99.NK.A13		RD	▼	ER-32	-	63	6000	55
99.NK.A14		RD	▼	ER-32	• 70bar	63	6000	55
99.NK.A23		RD	▼	ER-32	-	63	6000	65
99.NK.A24		RD	▼	ER-32	• 70bar	63	6000	65
99.NK.A15		RD	▼	ER-32	-	63	6000	75
99.NK.A16		RD	▼	ER-32	• 70bar	63	6000	75
99.NK.A71		RD 2U	▼ ▼	ER-25-25	-	63	6000	55

Code		Orient	Rotation	Output	Int. Coolant	Nm	Rpm	H
99.NK.A81	BMT55	RD 2U	▼ ▼	ER-25-25	-	63	6000	65
99.NK.A91		RD 2U	▼ ▼	ER-25-25	-	63	6000	75
99.NK.A22		UN ±90°	▼	ER-20	-	15	6000	71
99.NK.A32		UN ±90°	▼	ER-20	● 70bar	15	6000	71

Code		Orient	Rotation	Output	Int. Coolant	Nm	Rpm	H
99.NK.A51	BMT65	AX	▼	ER-32	-	63	6000	Max 77,9
99.NK.A52		AX	▼	ER-32	● 70bar	63	6000	Max 77,9
99.NK.A58		RD	▼	ER-32	-	63	6000	65
99.NK.A62		RD	▼	ER-32	● 70bar	63	6000	65
99.NK.A78		RD 2U	▼ ▼	ER-32-32	-	63	6000	65
99.NK.A82		UN ±90°	▼	ER-25	-	25	6000	80



- * PF Portafresa - Shell end milling cutter
- Refrigerante Interno - Internal Coolant
- (C) (▼) Disponibile variante con senso di rotazione uguale al mandrino
Available type with direction of rotation same as machine spindle
- ▼ Senso di rotazione opposto al mandrino
Direction of rotation opposite of machine spindle
- ▼ Senso di rotazione uguale al mandrino
Direction of rotation same as machine spindle

LATHE MODELS COMPATIBLES:



BMT 44

- WT 100
- NTY 3



BMT 55

- SUPER NTJ / NTJX
- NTM3
- TMC18
- TW10
- SC150 - 250
- WT150 - 250
- WTW 150
- WTS 150



BMT 65

- TW20
- SC300
- WT300

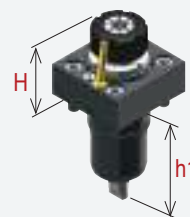

AX
Assiale
Axial

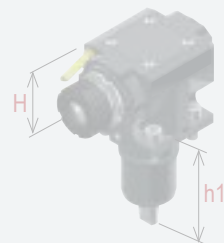

Off AX
Assiale disassato
Off-set axis

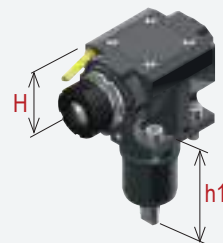

RD
Radiale
Radial

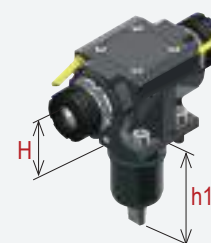

RD - 2U
Radiale doppia uscita
Radial double output

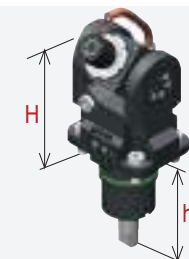

UN
Regolabile ±90°
Adjustable

LATHE MODELS COMPATIBLES:

**BMT
60**

- SPACE TURN LP2000 EX
- LB2500 EX
- LB3000 EX
- GENOS SERIES L300MW
- MULTUS U3000 / U4000
- LU3000EX M / MY

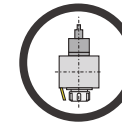
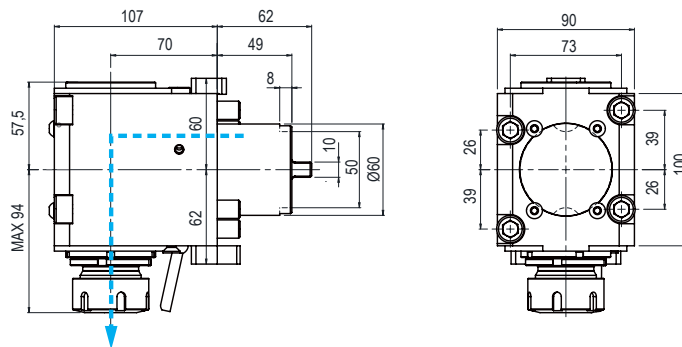
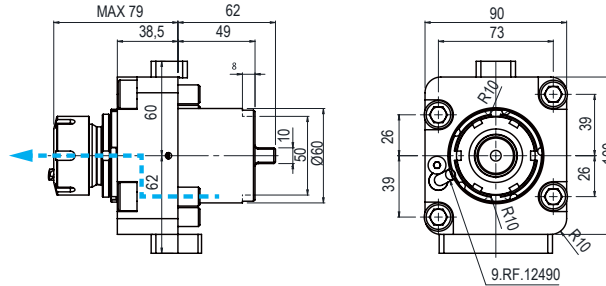

AX

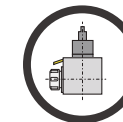

RD

Code		Orient	Rotation	Output	Int. Coolant	Nm	Rpm	H
99.OK.A80	BMT60	AX	▼	ER-32	-	60	6000	Max 79
99.OK.A81		AX	▼	ER-32	• 70bar	60	6000	Max 79

Code		Orient	Rotation	Output	Int. Coolant	Nm	Rpm	H
99.OK.A82	BMT60	RD	▼	ER-32	-	60	6000	70
99.OK.A83		RD	▼	ER-32	• 70bar	60	6000	70



LATHE MODELS COMPATIBLES:

BMT 65

- M06D
- M06SD
- M06SY
- M08D
- M08SD
- M08SY

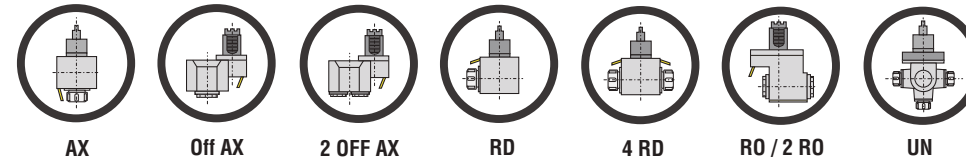
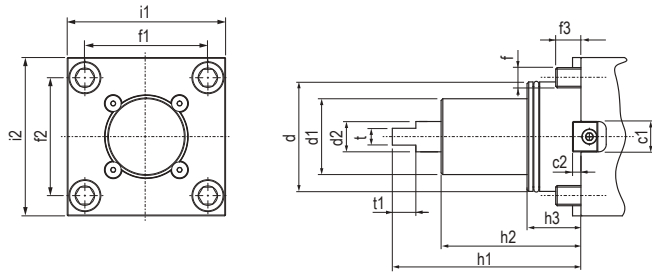

Code		Orient	Rotation	Output	Int. Coolant	Nm	Rpm	H
99.TS.A01	BMT65	AX	▼	ER-25	-	40	8000	55-60
99.TS.A02		AX	▼	ER-25	• 70bar	40	8000	55-60
99.TS.A03		AX	▼	ER-32	-	40	8000	62-67
99.TS.A04		AX	▼	ER-32	• 70bar	40	8000	62-67
99.TS.A05		Off-AX	▼	ER-25	-	40	8000	93-98
99.TS.A06		Off-AX	▼	ER-25	• 100bar	40	8000	93-98
99.TS.A07		2 Off-AX	▼	ER-20	-	45	6000	84-89
99.TS.A08		RD	▼	ER-25	-	40	8000	65
99.TS.A09		RD	▼	ER-32	• 100bar	40	8000	65
99.TS.A10		RD	▼	ER-32	-	40	8000	65

Code		Orient	Rotation	Output	Int. Coolant	Nm	Rpm	H
99.TS.A11	BMT65	RD	▼	ER-32	• 100bar	40	8000	65
99.TS.A12		RD	▼	ER-25	-	40	8000	85
99.TS.A13		RD	▼	ER-25	• 100bar	40	8000	85
99.TS.A14		RD	▼	ER-32	-	40	8000	85
99.TS.A15		RD	▼	ER-32	• 100bar	40	8000	85
99.TS.A16		RD	▼	ER-32	-	70	8000	85
99.TS.A17		RO	▼	ER-25	-	40	8000	85
99.TS.A18		RO	▼	ER-25	• 100bar	40	8000	85
99.TS.A19		RO	▼	ER-32	-	40	8000	85



Code		Orient	Rotation	Output	Int. Coolant	Nm	Rpm	H
99.TS.A20	BMT65	RO	▼	ER-32	• 100bar	40	8.000	85
99.TS.A21		2 RO	▼	ER-25	-	40	8.000	85
99.TS.A22		2 RO	▼	ER-32	-	40	8.000	85
99.TS.A23		4 RD	▼	ER-20	-	40	6.000	103
99.TS.A24		ADJ	▼	ER-20	-	15	8.000	65
99.TS.A25		ADJ	▼	ER-20	• 70bar	40	8.000	65

- * PF Portafresa - Shell end milling cutter
- Refrigerante Interno - Internal Coolant
- (C) (▼) Disponibile variante con senso di rotazione uguale al mandrino
Available type with direction of rotation same as machine spindle
- ▼ Senso di rotazione opposto al mandrino
Direction of rotation opposite of machine spindle
- ▼ Senso di rotazione uguale al mandrino
Direction of rotation same as machine spindle

LATHE MODELS COMPATIBLES:

- BMT 65**
- M06D
 - M06SD
 - M06SY
 - M08D
 - M08SD
 - M08SY

