



*Parallel plates, stack type, special jaws and spindle clamping devices*

## **STD - StandardFLEX - XL**

**Parti di ricambio / Spare Parts**

**INDICE - INDEX**

pages		pages		pages		pages		pages		pages	
Art.	4.	Art.	4.	Art.	4.	Art.	4.	Art.	4.	Art.	4.
<b>1E</b>	40-41	<b>191</b>	29	<b>243K</b>	16-17	<b>302</b>	29	<b>390/4</b>	44	<b>397B</b>	47
<b>1F</b>	42-43	<b>192</b>	25	<b>243S</b>	11	<b>303</b>	29	<b>390A/2</b>	44	<b>397C</b>	51
<b>105</b>	31	<b>192S</b>	25	<b>244</b>	11	<b>303A</b>	30	<b>390A/3</b>	44	<b>397D</b>	51
<b>120</b>	8	<b>200</b>	19	<b>245</b>	11	<b>304</b>	29	<b>390A/4</b>	44	<b>398</b>	47
<b>120A</b>	20	<b>201</b>	19	<b>246</b>	11	<b>305</b>	29	<b>390B</b>	48	<b>398B</b>	47
<b>121</b>	8	<b>203</b>	19	<b>246G</b>	14-15	<b>306</b>	29	<b>390B/2</b>	48	<b>398C</b>	51
<b>123</b>	8	<b>204</b>	19	<b>246K</b>	16-17	<b>306A</b>	30	<b>390B/3</b>	48	<b>398D</b>	51
<b>123A</b>	20	<b>206</b>	19	<b>246T</b>	11-12	<b>306B</b>	30	<b>390B/4</b>	48	<b>399</b>	52
<b>124</b>	8	<b>207</b>	19	<b>247</b>	11-12	<b>306C</b>	30	<b>390C</b>	48	<b>400</b>	52
<b>126</b>	8	<b>208</b>	19	<b>247G</b>	14-15	<b>307</b>	29	<b>390C/2</b>	48	<b>401</b>	52
<b>126A</b>	20	<b>209</b>	19	<b>247K</b>	16-17	<b>308</b>	29	<b>390C/3</b>	48	<b>402</b>	52
<b>127</b>	8	<b>210</b>	24	<b>247T</b>	11	<b>309</b>	29	<b>390C/4</b>	48	<b>402/90</b>	52
<b>127A</b>	20	<b>211</b>	24	<b>248</b>	9	<b>313</b>	27	<b>391</b>	45	<b>403</b>	52
<b>128</b>	8	<b>212</b>	23	<b>248G</b>	14-15	<b>313A</b>	26	<b>391/2</b>	45	<b>404</b>	52
<b>129</b>	8	<b>213</b>	23	<b>248K</b>	16-17	<b>313R</b>	27	<b>391/3</b>	45	<b>405</b>	35
<b>132</b>	28	<b>214</b>	23	<b>248S</b>	9	<b>314</b>	27	<b>391/4</b>	45	<b>405H</b>	52
<b>133</b>	28	<b>215</b>	23	<b>249</b>	9	<b>315</b>	30	<b>391A/2</b>	45	<b>407</b>	44
<b>134</b>	28	<b>217</b>	24	<b>249G</b>	14-15	<b>316</b>	30	<b>391A/3</b>	45	<b>407A</b>	45
<b>135</b>	28	<b>218</b>	24	<b>249K</b>	16-17	<b>317</b>	26	<b>391A/4</b>	45	<b>407B</b>	46
<b>140</b>	10	<b>220F</b>	15-17	<b>249S</b>	9	<b>318</b>	30	<b>391B</b>	49	<b>407C</b>	48
<b>140G</b>	13	<b>224</b>	23	<b>250</b>	9	<b>319</b>	30	<b>391B/2</b>	49	<b>407D</b>	49
<b>140T</b>	12	<b>225</b>	23	<b>251</b>	9	<b>320</b>	22	<b>391B/3</b>	49	<b>407E</b>	50
<b>141</b>	10	<b>220 G01</b>	15-17	<b>252</b>	9	<b>320A</b>	22	<b>391B/4</b>	49	<b>410</b>	36
<b>141G</b>	13	<b>220 G02</b>	15-17	<b>253</b>	9	<b>321</b>	30	<b>391C/2</b>	49	<b>420</b>	31
<b>141T</b>	12	<b>220 G11</b>	15-17	<b>257</b>	37	<b>322</b>	30	<b>391C/3</b>	49	<b>430</b>	31
<b>143</b>	10	<b>230</b>	9	<b>258</b>	36	<b>323</b>	30	<b>391C/4</b>	49	<b>431</b>	28
<b>143G</b>	13	<b>230B</b>	21	<b>260</b>	28	<b>324</b>	30	<b>392</b>	46	<b>440</b>	28
<b>143T</b>	12	<b>230C</b>	21	<b>270A</b>	53	<b>325</b>	35	<b>392/2</b>	46	<b>505</b>	53
<b>144</b>	10	<b>230D</b>	21	<b>270B</b>	53	<b>355</b>	36	<b>392/3</b>	46	<b>570</b>	28
<b>144G</b>	13	<b>230E</b>	21-22	<b>271</b>	54	<b>356</b>	36	<b>392/4</b>	46	<b>570S</b>	28
<b>144T</b>	12	<b>230F</b>	21	<b>271D</b>	54	<b>357</b>	35	<b>392A/2</b>	46	<b>605 G1</b>	22
<b>146</b>	10	<b>230G</b>	21	<b>272</b>	53	<b>360</b>	36	<b>392A/3</b>	46	<b>605 G2</b>	22
<b>146G</b>	13	<b>230H</b>	21	<b>272A</b>	53	<b>361</b>	36	<b>392A/4</b>	46	<b>605 G3</b>	22
<b>146T</b>	12	<b>230K</b>	21	<b>282</b>	36	<b>362</b>	28	<b>392B</b>	50	<b>ID 03</b>	53
<b>147</b>	10	<b>230L</b>	21	<b>283</b>	54	<b>365</b>	31	<b>392B/2</b>	50	<b>ID 04</b>	53
<b>147G</b>	13	<b>230M</b>	21	<b>284</b>	37	<b>366</b>	31	<b>392B/3</b>	50	<b>ID 05</b>	53
<b>147T</b>	12	<b>230S</b>	9	<b>285</b>	54	<b>367</b>	31	<b>392B/4</b>	50	<b>981</b>	3
<b>148</b>	10	<b>230SLD</b>	21	<b>286</b>	37	<b>368</b>	31	<b>392C/2</b>	50	<b>985</b>	3
<b>148G</b>	13	<b>230SLE</b>	21	<b>287</b>	34	<b>370</b>	35	<b>392C/3</b>	50		
<b>149</b>	10	<b>231</b>	9	<b>290</b>	37-38	<b>370A</b>	35	<b>392C/4</b>	50		
<b>149G</b>	13	<b>231S</b>	9	<b>291</b>	35	<b>375</b>	35	<b>393</b>	47		
<b>152</b>	24	<b>232</b>	9	<b>292</b>	37	<b>376</b>	35	<b>393D</b>	51		
<b>160</b>	18	<b>233</b>	9	<b>293</b>	37	<b>377</b>	35	<b>394</b>	47		
<b>161</b>	18	<b>234</b>	9	<b>294</b>	37	<b>380</b>	28	<b>394D</b>	51		
<b>163</b>	18	<b>235</b>	9	<b>295</b>	37	<b>381</b>	28	<b>395</b>	47		
<b>164</b>	18	<b>242</b>	11	<b>296</b>	33	<b>382</b>	28	<b>395D</b>	51		
<b>166</b>	18	<b>242G</b>	14-15	<b>297</b>	34	<b>383</b>	28	<b>396</b>	47		
<b>167</b>	18	<b>242K</b>	16-17	<b>298</b>	33	<b>384</b>	28	<b>396B</b>	47		
<b>168</b>	18	<b>242S</b>	11	<b>300</b>	29	<b>390</b>	44	<b>396C</b>	51		
<b>169</b>	18	<b>243</b>	11	<b>300A</b>	30	<b>390/2</b>	44	<b>396D</b>	51		
<b>190</b>	29	<b>243G</b>	14-15	<b>301</b>	29	<b>390/3</b>	44	<b>397</b>	47		

# VALIGETTA DI CAMPIONATURA STD / StdFLEX SAMPLE KIT CASE STD / StdFLEX



## Art. 981

Valigetta di campionatura  
morsa Art.1  
Sample kit case Art.1 vise

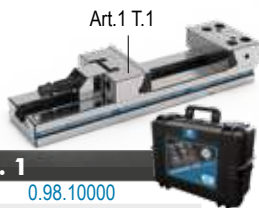

### Morsa / Vise Art. 1

Cod. 0.98.10000

## Art. 985

Valigetta di campionatura  
morsa Art.1A  
Sample kit case Art.1A vise



### Morsa / Vise Art. 1A

Cod. 0.98.50000

### Art. 1 - All'Interno - Inside:

Art.132	Art.313	Art.298	Art.147	Art.283	Art.376
Art.133	Art.314	Art.370	Art.212	Art.285	Art.217
Art.138	Art.271	Art.375	Art.297		

### Art. 1A - All'Interno - Inside:

Art.138	Art.212	Art.230B	Art.230C	Art.230D	Art.230E
Art.230F	Art.230G	Art.230H	Art.230M	Art.313	Art.314
Art.271	Art.297	Art.298	Art.370	Art.375	Art.376

## SIMBOLOGIA DATI TECNICI TECHNICAL DATA ICONS

GANASCE JAWS		Fissa Fixed		Mobile Movable		Intermedia Intermediate		Fissa con piastra singola Fixed with single plate		Fissa con piastra doppia Fixed with double plate		Ganasce sovrapponibili Stack Type Jaws
		Discendente Pull down		Discendente + inserti GRIP Pull down + GRIP inserts		Lavorabile Machineable		Cambio rapido manuale Quick manual change		GRIP integrale Integral GRIP		Inserti GRIP Inserti GRIP
PIASTRE GANASCE JAW PLATES												
POSSIBILITÀ POSSIBILITY												
PAGINE PAGES		Accessori & Ricambi Accessories & Spare Parts		Istruzioni corretto utilizzo Instruction for a proper use		Diagrammi forze di serraggio Clamping force diagrams		Accessori idraulici Hydraulic accessories		Centraline idrauliche Hydraulic Power Units		Centraline idrauliche Hydraulic Power Units
		Comando manuale Manual control		Comando elettrico Solenoid control		Comando pneumatico Pneumatic control						

## Parti di ricambio / Spare parts

# STD / StdFLEX / XL

**Un'ampia scelta di componenti ed accessori modulari !**

*Wide range of components and modular accessories !*

### USURA INESISTENTE / NO WEAR

Grazie all'accurata scelta dei materiali impiegati ed allo studio dimensionale computerizzato dei componenti. Costruzione completamente in speciali leghe di acciaio ad alta resistenza, normalizzato, cementato e temprato con durezza  $60 \pm 2$  HRC. Tutto ciò al fine di conferire massima rigidità, elevate prestazioni e usura inesistente. A riprova di tutto ciò assicuriamo **5 ANNI DI GARANZIA** su tutto il programma morse e organi meccanici in genere.

Thanks to the manufacturing with only the most suitable materials and to the structure of the vise components (developed using computer customised softwares and the experience gained during many years spent working on the specific field). High alloyed quality resistance steel, case hardened HRC  $60 \pm 2$ , is used in manufacturing all the Gerardi vises and accessories in order to give maximum rigidity, high performances and no wear. As evidence we give **5 YEARS WARRANTY** on all the vises and mechanical components.

### MODULARITÀ / MODULARITY

Tutte le morse ed accessori sono elementi componibili, intercambiabili e perfettamente allineabili fra loro e con i quali è possibile ottenere differenti soluzioni di bloccaggio. Secondo tale principio l'unico elemento che differenzia le attrezzature con identica larghezza di presa è la base (la cui lunghezza determina la massima apertura della morsa), mentre gli altri componenti sono identici. Mediante l'aggiunta o semplice sostituzione di alcuni particolari si può variare la tipologia di bloccaggio secondo le proprie esigenze utilizzando la stessa attrezzatura acquistata in un primo momento (bloccaggi singoli, con base girevole, doppi, verticali, di pezzi piani, tondi, piatti e grezzi, manuali, idraulici o pneumatici).

All vises and accessories are modular and components of all our vises will interchange with perfect alignment to provide different workholding solutions. With this basic principle the only difference between fixtures with the same width of clamping is the base (whose length determines the maximum opening of the vise), while the rest of components have same dimensions. Through the simple addition or substitution of some particulars You can change the type of clamping as Your needs require using the same fixture purchased before (single clamping, swivel base, double, vertical, smooth or round or flat or rough workpieces, manual, hydraulic or pneumatic).

### DESIGN COMPATTO / SPACE SAVING DESIGN

La semplicità nonché la compattezza costruttiva consentono un'apertura notevole rispetto all'ingombro totale dell'attrezzatura. Inoltre lo stesso peso (solo 25 kg per una morsa da 150 mm di larghezza ganasca) è tale da consentire un facile trasferimento da una macchina all'altra.

The space saving design and solid construction allow a maximum blocking ratio to total overall dimension of the vise. Furthermore the weight (only 25 kg for a 150 mm jaw width vise) allows a simple moving from one machine to another.

### SERRAGGI RAPIDI / QUICK CLAMPING

Grazie allo scorrimento del gruppo di serraggio nella guida della base (a cremagliera) fino in prossimità del pezzo da lavorare dove si adatterà automaticamente alla nicchia più vicina. L'operazione di serraggio si conclude agendo sulla vite di bloccaggio. Oltre a quello manuale meccanico, sono disponibili 4 ulteriori sistemi di serraggio intercambiabili e indipendenti: 1 - Idraulici / 2 - Pneumatici / 3 - Idraulici manuali / 4 - Idraulici elettrici. L'operazione è in termini di secondi.

Thanks to the clamping device sliding in the vise base slide (compact rack type) till the proximity of the workpiece. The clamping is completed with the main screw. Besides the manual mechanic system, 4 further interchangeable and independent clamping systems are available: 1- Hydraulic / 2- Pneumatic / 3- Manual hydraulic / 4- Electrical hydraulic. The change needs only few seconds.

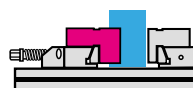

### Art.131 / 138 / 150

**Ganasce Sovrapponibili**

*Stack type jaws*



### Art.210

**Ganasce mobili guidate monoblocco per pezzi tondi**

*Solid guided movable jaws for round workpieces*

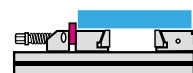

### Art.132 / 133

**Prolunga per ganasce mobili e fisse**

*Extension for movable and fixed jaws*

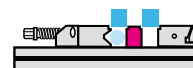

### Art.212

**Ganasca mobile intermedia con doppio gradino**

*Intermediate movable jaws with double step*

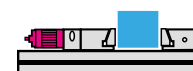

### Art.257 / 258 / 271

**Gruppi di serraggio**

*Spindle clamping devices*

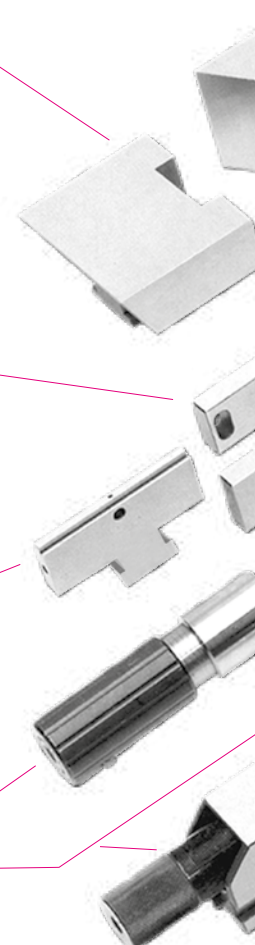

Sicuramente uno dei punti di forza del sistema modulare GERARDI consiste nell'ampissima scelta di componentistica ed accessori nonché nel continuo investimento e sviluppo nei più avanzati concetti e soluzioni originali. Il programma che viene presentato nelle pagine seguenti fa parte di un sistema modulare di bloccaggio fra i più ampi e completi a livello mondiale che permette realmente di trasformare in standard ciò che sembrerebbe essere speciale (oltre 1000 articoli moltiplicati per 6 grandezze diverse). Il segreto di tutto ciò sta proprio nella modularità del sistema che consente (con l'aggiunta di alcuni componenti) una più ampia gamma di impieghi.

One of the biggest point of strength of GERARDI modular system lies in the broadest assortment program of components and accessories and also in the continuous investment and development of the most advanced concepts and original solutions. The range of items shown in the following pages is part of a modular workholding system among the widest and complete in the world. So, any holding and clamping issue You ever have, You can solve it with Gerardi standard modular products. The secret lies just in the modularity of the system which allows (choosing different components) a wider range of solutions.



SCAN IT TO WATCH THE



VIDEO PRESENTATION



*Parallele, ganasce sovrapponibili,  
speciali e gruppi di serraggio  
intercambiabili*

*Parallel plates, stack type & special  
jaws and interchangeable  
clamping devices*

4

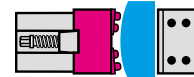
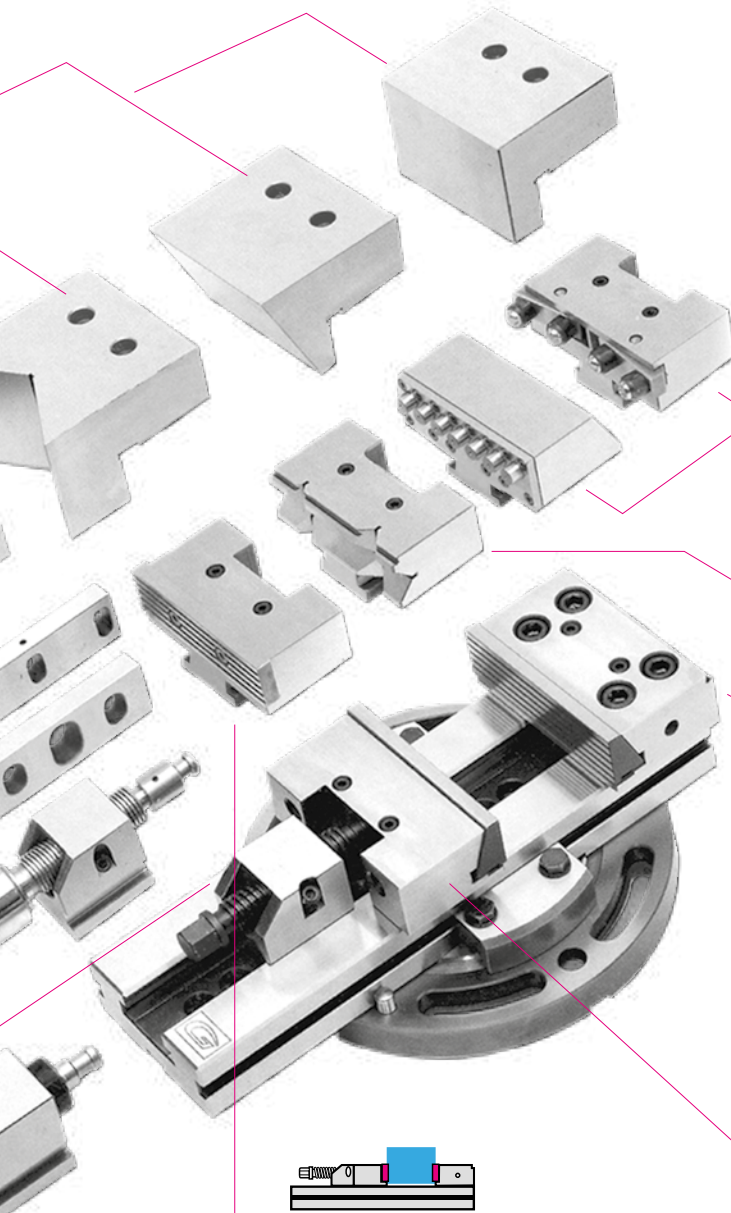

### Art.190 / 188

**Ganasce mobili guidate monoblocco**

Solid guided movable jaws

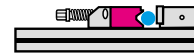

### Art.217

**Ganasce mobili guidate monoblocco prismatiche (per serraggio pezzi piatti e tondi)**

Solid guided movable prismatic jaws (for plates & round workpieces clamping)

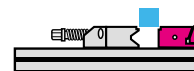

### Art.120

**Le ganasce fisse monoblocco consentono, una volta ruotate di 180°, il perfetto accoppiamento al gradino della ganascia prismatica mobile (Art. 217) ordinabile separatamente.**

The solid standard fixed jaws with 5x5 mm back steps are matchable, if turned of 180°, to the prismatic movable jaw (Art.217) to be ordered separately.

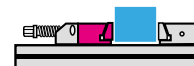

### Art.127

**Ganascia mobili guidate monoblocco costruite con un angolo di spinta verso il basso.**

Guided movable jaws built in one solid body with a pull down angle

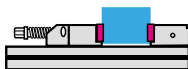

### Art.246

**Ganasce mobili guidate monoblocco con piastre piane**

Solid guided movable jaw with straight plates

## Parti di ricambio / Spare parts

# Standard / StdFLEX / XL

### Piastre ganasce discendenti intercambiabili manualmente

Pull down jaws plates interchangeable by hand

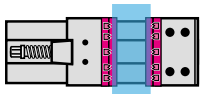
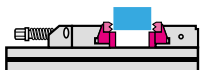

**Art. 242G**

**Art. 246G**

Pagina / Page 4.14

Larghezza Normale e Ridotta  
Normal & Narrow Width

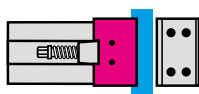
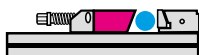

**Art. 210**

Pagina  
Page 4.24

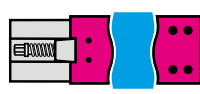

**Art. 160**

Pagina  
Page 4.18

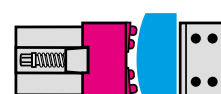
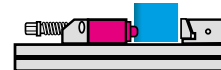

**Art. 192**

Pagina  
Page 4.25

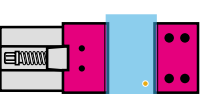

**Art. 200**

Pagina  
Page 4.19

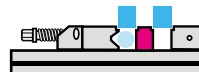

**Art. 212**

Pagina  
Page 4.23

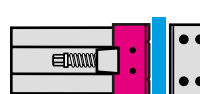
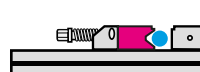

**Art. 217**

Pagina  
Page 4.24

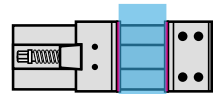
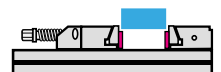

**Art. 313**

**Art. 314**

Pagina / Page 4.27  
Normali e angolari  
Normal & angular



### PIASTRE GANASCE COMPATIBILI SOLO CON MORSE STDFLEX

JAW PLATES COMPATIBLE ONLY WITH STDFLEX VISES



**Art. 230SLD**

Pagina  
Page 4.21



**Art. 230B**

Pagina  
Page 4.21

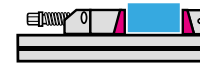

**Art. 230C**

Pagina  
Page 4.21



**Art. 230D**

Pagina  
Page 4.21

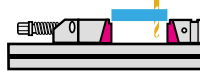

**Art. 230E**

Pagina  
Page 4.21

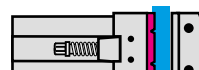
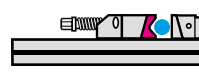

**Art. 230F**

Pagina  
Page 4.21

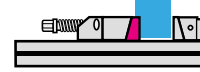

**Art. 230G**

Pagina  
Page 4.21

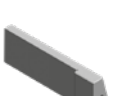

**Art. 230H**

Pagina  
Page 4.21



## Soluzioni personalizzate / Customized solutions

# Standard / StdFLEX / XL

### Soluzioni personalizzate a tutti i vostri problemi di serraggio

*Customized solutions for all your clamping problems*

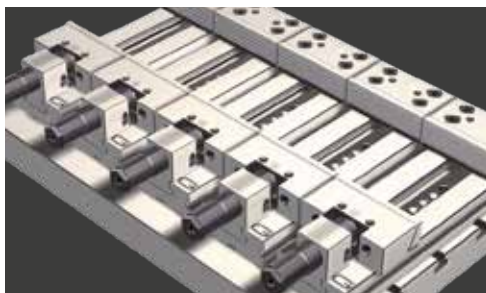

#### Serraggi idraulici

*Hydraulic clamping*

#### Morse Modulari di Precisione accoppiabili ed allineabili per serraggi multipli idraulici

Precision Modular vises matchable for gang operations and hydraulic clamping

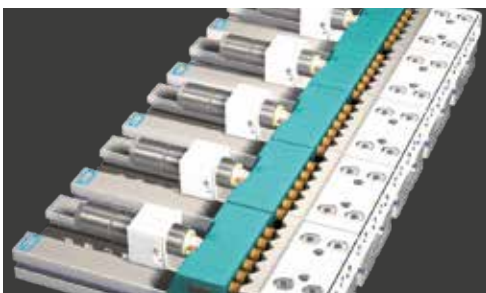

#### Serraggi multipli

*Multiple clamping*

#### Morse Modulari di Precisione accoppiabili ed allineabili per serraggi multipli idraulici con ganasce speciali oleodinamiche interfacciate a piastre ganasce con inserti prismatici

Matchable and alignable precision modular vises for multiple hydraulic clamping through special hydraulic jaws interfaced to prismatic inserts jaw plates.



#### Morse StandardMatic

*StandardMatic vises*

#### Morse StandardMatic montate in serie su centro di lavoro verticale

StandardMatic vises series mounted on vertical machining centres

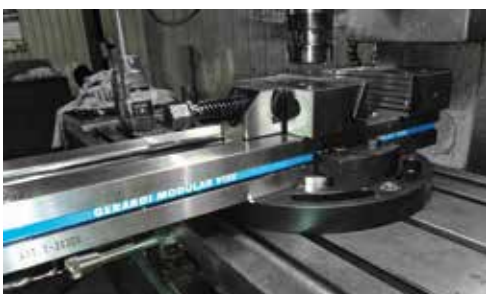

#### Art.2

*Art.2*

#### Morse Standard Art.1 montate con base girevole graduata su centro di lavoro verticale, per una maggiore versatilità su 360°

Standard vise Art.1 mounted with graduated swivel base on vertical machining centre for a greatest versatility 360°



#### Ganasce con inserti Grip

*Insert Grip jaw plate*

#### Morsa Standard con piastre ganasce a gradino con inserti Grip per un serraggio più efficace

Standard vise equipped with insert grip step jaw plate for more effective workpiece clamping

# GANASCE STANDARD / STANDARD JAWS

Tipo (grandezza) morsa / Vise type (size)	1	2	3	4	5	6
<b>Art. 120</b> W - W3 Ganascia fissa. <b>Larghezza normale</b> (W) - (W3) Fixed jaw. <b>Normal width</b> (W) - (W3)						
	Cod. 2.12.01000	2.12.02000	2.12.03000	2.12.04000	2.12.05000	2.12.06000
<b>Art. 121</b> W2 - W1 Ganascia fissa. <b>Larghezza ridotta</b> rettificata (W2) - (W1) Fixed jaw. <b>Narrow width</b> ground (W2) - (W1)						
	Cod. 2.12.11000	2.12.12000	2.12.13000	2.12.14000	2.12.15000	2.12.16000
<b>Art. 123</b> W - W3 Ganascia fissa doppia. <b>Larghezza normale</b> (W) - (W3) Double fixed jaw. <b>Normal width</b> (W) - (W3)						
	Cod. 2.12.31000	2.12.32000	2.12.33000	2.12.34000	2.12.35000	2.12.36000
<b>Art. 124</b> W2 - W1 Ganascia fissa doppia. <b>Larghezza ridotta</b> rettificata (W2) - (W1) Double fixed jaw. <b>Narrow width</b> ground (W2) - (W1)						
	Cod. 2.12.41000	2.12.42000	2.12.43000	2.12.44000	2.12.45000	2.12.46000
<b>Art. 127</b> W - W3 Ganascia mobile monoblocco guidata. <b>Larghezza normale</b> (W) - (W3) Guided movable solid jaw. <b>Normal width</b> (W) - (W3)						
	Cod. 2.12.71000	2.12.72000	2.12.73000	2.12.74000	2.12.75000	2.12.76000
<b>Art. 129</b> W2 - W1 Ganascia mobile monoblocco guidata. <b>Larghezza ridotta</b> (W2) - (W1) Guided movable solid jaw. <b>Narrow width</b> (W2) - (W1)						
	Cod. 2.12.91000	2.12.92000	2.12.93000	2.12.94000	2.12.95000	2.12.96000
<b>Art. 126</b> W - W3 Ganascia mobile <b>oscillante</b> . <b>Larghezza normale</b> (W) - (W3) <b>Floating</b> movable jaw. <b>Normal width</b> (W) - (W3)						
	Cod. 2.12.61000	2.12.62000	2.12.63000	2.12.64000	2.12.65000	2.12.66000
<b>Art. 128</b> W2 - W1 Ganascia mobile <b>oscillante</b> . <b>Larghezza ridotta</b> (W2) - (W1) <b>Floating</b> movable jaw. <b>Narrow width</b> (W2) - (W1)						
	Cod. 2.12.81000	2.12.82000	2.12.83000	2.12.84000	2.12.85000	2.12.86000

## Art. 120

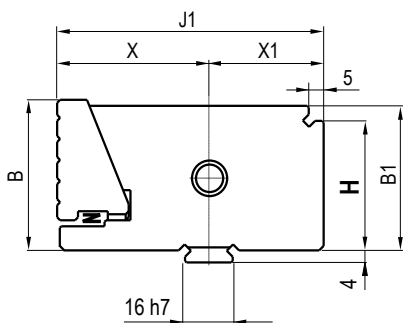

## Art. 123

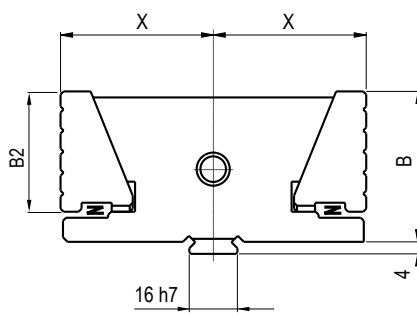

## Art. 127

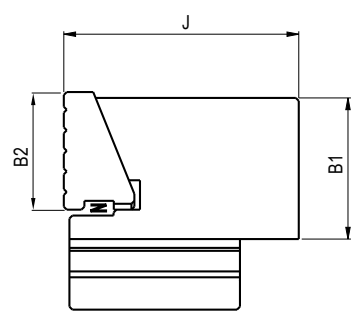

Tipo / Type	1	2	3	4	5	6
W = Jaw plate	100	125	150	175	200	300
W1 = Jaw body	75	95	125	145	170	195
W2 = Jaw plate	74	94	124	144	169	194
W3 = Jaw body	96	121	146	171	196	296
Y	21	28	41	51	61	71
Y - 1	20	27	40	50	60	70
B	30	40	50	60	65	80
B1	28	38	48	58	63	78
B2	24,5	32	39	43	53	63
* H	23	33	43	53	53	68
J	50	60	80	90	100	120
X	42,4	42,4	50,9	55,4	66,4	73,1
X1	35,5	35,5	38,5	41,5	47	47
J1	77,9	77,9	89,4	96,9	113,4	120,1

\* DIMENSIONE DA ACCOPPIARE AD Art. 212 + 217 + 214 - DIMENSION TO BE MATCHED WITH Art. 212 + 217 + 214

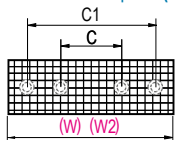
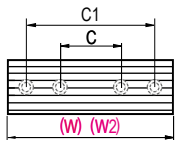

# RICAMBI PER GANASCE STANDARD / SPARES FOR STANDARD JAWS

**Tipo (grandezza) morsa / Vise type (size)**
**1      2      3      4      5      6**
**PIASTRE TEMPRATE RIGATE O QUADRETTATE**
**HARDENED GROOVED OR SERRATED JAW PLATES**
**Standard**
**A richiesta / On request (EXTRA)**

**Art. 230 (W)**
**Art. 230S (W)**

 Per ganascia fissa e mobile - Art. 120, 126, 127 - Larghezza normale (W)  
 For fixed and movable jaw - Art. 120, 126, 127 - Normal width (W)

**Art. 231**
**Art. 231S**

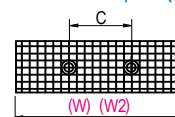
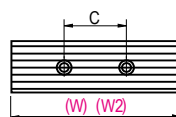
 Per ganascia fissa e mobile - Art. 121, 128, 129 - Larghezza ridotta (W2)  
 For fixed and movable jaw - Art. 121, 128, 129 - Narrow width (W2)

**Standard**
**A richiesta / On request (EXTRA)**

**Art. 248 (W)**
**Art. 248S (W)**

 Per ganascia fissa doppia Art. 123 - Larghezza normale (W)  
 For double fixed jaw Art. 123 - Normal width (W)

**Art. 249 (W2)**
**Art. 249S (W2)**

 Per ganascia fissa doppia Art. 124 - Larghezza ridotta (W2)  
 For double fixed jaw Art. 124 - Narrow width (W2)

**PIASTRE LISCE TEMPRATE**
**HARDENED SMOOTH JAW PLATES**

Fornibili a richiesta già montate, a metà prezzo se in aggiunta all'acquisto della morsa

Available on request already mounted, at half price if purchased extra with the vise

**Art. 232 (W)**

 Per ganascia fissa e mobile - Art. 120, 127, 129 - Larghezza normale (W)  
 For fixed and movable jaw - Art. 120, 127, 129 - Normal width (W)

**Art. 233 (W2)**

 Per ganascia fissa e mobile - Art. 121, 128, 129 - Larghezza ridotta (W2)  
 For fixed and movable jaw - Art. 121, 128, 129 - Narrow width (W2)

**Art. 250 (W)**

 Per ganascia fissa doppia Art. 123 - Larghezza normale (W)  
 For double fixed jaw Art. 123 - Normal width (W)

**Art. 251 (W2)**

 Per ganascia fissa doppia Art. 124 - Larghezza ridotta (W2)  
 For double fixed jaw Art. 124 - Narrow width (W2)

**PIASTRE IN ACCIAIO LAVORABILE (DOLCE)**
**MACHINEABLE STEEL JAW PLATES (SOFT)**

Fornibili a richiesta già montate, a metà prezzo se in aggiunta all'acquisto della morsa

Available on request already mounted, at half price if purchased extra with the vise

**Art. 234 (W)**

 Per ganascia fissa e mobile - Art. 120, 127, 129 - Larghezza normale (W)  
 For fixed and movable jaw - Art. 120, 127, 129 - Normal width (W)

**Art. 235 (W2)**

 Per ganascia fissa e mobile - Art. 121, 128, 129 - Larghezza ridotta (W2)  
 For fixed and movable jaw - Art. 121, 128, 129 - Narrow width (W2)

**Art. 252 (W)**

 Per ganascia fissa doppia Art. 123 - Larghezza normale (W)  
 For double fixed jaw Art. 123 - Normal width (W)

**Art. 253 (W2)**

 Per ganascia fissa doppia Art. 124 - Larghezza ridotta (W2)  
 For double fixed jaw Art. 124 - Super narrow width (W2)

Per qualsiasi piastra ganascia speciale, raddoppiare il prezzo / For special tailor made jaw plate double the price

W	100	125	150	175	200	300
W2	74	94	124	144	169	194
A	14	20	24	24	29	35
B2	24,5	32	39	43	53	63
C	20	32	50	50	76	90
C1	62	80	90	116	138	184

Cod. Art. 230	1.65.10000	1.65.20000	1.65.30000	1.65.40000	1.65.50000	1.65.60000
Cod. Art. 230S	4.23.0S100	4.23.0S200	4.23.0S300	4.23.0S400	4.23.0S500	4.23.0S600

Cod. Art. 231	1.65.11000	1.65.21000	1.65.31000	1.65.41000	1.65.51000	1.65.61000
---------------	------------	------------	------------	------------	------------	------------

Cod. Art. 231S	4.23.1S100	4.23.1S200	4.23.1S300	4.23.1S400	4.23.1S500	4.23.1S600
----------------	------------	------------	------------	------------	------------	------------

**ATTENZIONE - ATTENTION:**

IN FASE D'ORDINE VERIFICARE QUOTE C - C1 - CHECK DIMENSIONS C - C1 IN CASE OF ORDER

Cod. Art. 248	1.65.14000	1.65.24000	1.65.34000	1.65.44000	1.65.54000	1.65.64000
Cod. Art. 248S	4.24.8S100	4.24.8S200	4.24.8S300	4.24.8S400	4.24.8S500	4.24.8S600

Cod. Art. 249	1.65.15000	1.65.25000	1.65.35000	1.65.45000	1.65.55000	1.65.65000
Cod. Art. 249S	4.24.9S100	4.24.9S200	4.24.9S300	4.24.9S400	4.24.9S500	4.24.9S600

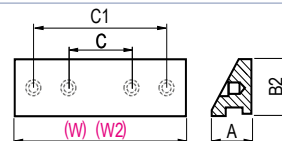

Cod. Art. 232	1.65.10100	1.65.20100	1.65.30100	1.65.40100	1.65.50100	1.65.60100
---------------	------------	------------	------------	------------	------------	------------

Cod. Art. 233	1.65.11100	1.65.21100	1.65.31100	1.65.41100	1.65.51100	1.65.61100
---------------	------------	------------	------------	------------	------------	------------

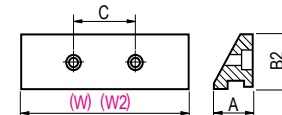

Cod. Art. 250	1.65.14100	1.65.24100	1.65.34100	1.65.44100	1.65.54100	1.65.64100
---------------	------------	------------	------------	------------	------------	------------

Cod. Art. 251	1.65.15100	1.65.25100	1.65.35100	1.65.45100	1.65.55100	1.65.65100
---------------	------------	------------	------------	------------	------------	------------

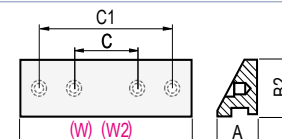

Cod. Art. 234	1.65.10200	1.65.20200	1.65.30200	1.65.40200	1.65.50200	1.65.60200
---------------	------------	------------	------------	------------	------------	------------

Cod. Art. 235	1.65.11200	1.65.21200	1.65.31200	1.65.41200	1.65.51200	1.65.61200
---------------	------------	------------	------------	------------	------------	------------

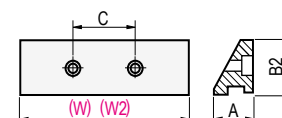

Cod. Art. 252	1.65.14200	1.65.24200	1.65.34200	1.65.44200	1.65.54200	1.65.64200
---------------	------------	------------	------------	------------	------------	------------

Cod. Art. 253	1.65.15200	1.65.25200	1.65.35200	1.65.45200	1.65.55200	1.65.65200
---------------	------------	------------	------------	------------	------------	------------

# GANASCE CON PIASTRE PIANE / STRAIGHT PLATE JAWS

Tipo (grandezza) morsa / Vise type (size)	1	2	3	4	5	6
<b>Art. 140</b> W - W3 Ganasia fissa. <b>Larghezza normale</b> (W) - (W3) Fixed jaw. <b>Normal width</b> (W) - (W3)	Cod. 2.14.01000	2.14.02000	2.14.03000	2.14.04000	2.14.05000	2.14.06000
<b>Art. 141</b> W2 - W1 Ganasia fissa. <b>Larghezza ridotta rettificata</b> (W2) - (W1) Fixed jaw. <b>Narrow width ground</b> (W2) - (W1)	Cod. 2.14.11000	2.14.12000	2.14.13000	2.14.14000	2.14.15000	2.14.16000
<b>Art. 143</b> W - W3 Ganasia fissa doppia. <b>Larghezza normale</b> (W) - (W3) Double fixed jaw. <b>Normal width</b> (W) - (W3)	Cod. 2.14.31000	2.14.32000	2.14.33000	2.14.34000	2.14.35000	2.14.36000
<b>Art. 144</b> W2 - W1 Ganasia fissa doppia. <b>Larghezza ridotta rettificata</b> (W2) - (W1) Double fixed jaw. <b>Narrow width ground</b> (W2) - (W1)	Cod. 2.14.41000	2.14.42000	2.14.43000	2.14.44000	2.14.45000	2.14.46000
<b>Art. 146</b> W - W3 Ganasia mobile monoblocco guidata. <b>Larghezza normale</b> (W) - (W3) Guided movable solid jaw. <b>Normal width</b> (W) - (W3)	Cod. 2.14.61000	2.14.62000	2.14.63000	2.14.64000	2.14.65000	2.14.66000
<b>Art. 147</b> W2 - W1 Ganasia mobile monoblocco guidata. <b>Larghezza ridotta</b> (W2) - (W1) Guided movable solid jaw. <b>Narrow width</b> (W2) - (W1)	Cod. 2.14.71000	2.14.72000	2.14.73000	2.14.74000	2.14.75000	2.14.76000
<b>Art. 148</b> W - W3 Ganasia mobile monoblocco oscillante. <b>Larghezza normale</b> (W) - (W3) Floating movable solid jaw. <b>Normal width</b> (W) - (W3)	Cod. 2.14.81000	2.14.82000	2.14.83000	2.14.84000	2.14.85000	2.14.86000
<b>Art. 149</b> W2 - W1 Ganasia mobile monoblocco oscillante. <b>Larghezza ridotta</b> (W2) - (W1) Floating movable solid jaw. <b>Narrow width</b> (W2) - (W1)	Cod. 2.14.91000	2.14.92000	2.14.93000	2.14.94000	2.14.95000	2.14.96000

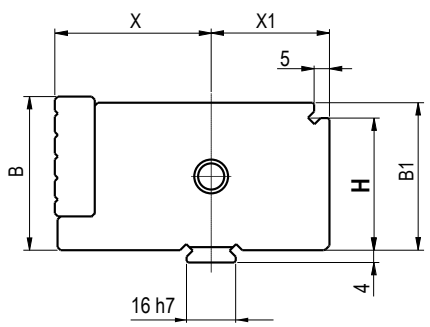
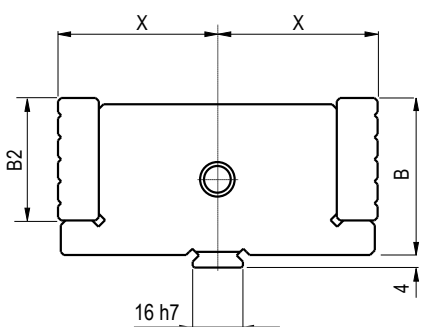
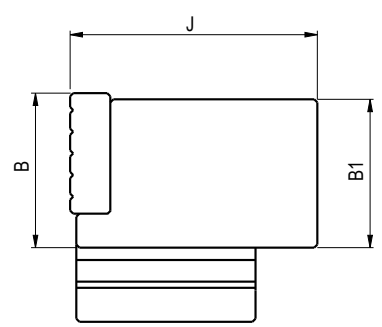
**Art. 140**

**Art. 143**

**Art. 146**

Tipo / Type	1	2	3	4	5	6
W = Jaw plate	100	125	150	175	200	300
W1 = Jaw body	75	95	125	145	170	195
W2 = Jaw plate	74	94	124	144	169	194
W3 = Jaw body	96	121	146	171	196	296
Y	21	28	41	51	61	71
Y1	20	27	40	50	60	70
B	30	40	50	60	65	80
B1	28	38	48	58	63	78
B2	24,5	32	40	43	48	63
<b>* H</b>	<b>23</b>	<b>33</b>	<b>43</b>	<b>53</b>	<b>53</b>	<b>68</b>
J	50	60	80	90	100	120
X	42,4	42,4	50,9	55,4	66,4	73,1
X1	35,5	35,5	38,5	41,5	47	47

\* DIMENSIONE DA ACCOPPIARE AD Art. 212 + 217 + 214 - DIMENSION TO BE MATCHED WITH Art. 212 + 217 + 214

# RICAMBI PER GANASCE CON PIASTRE PIANE / SPARES FOR STRAIGHT JAW PLATES

Tipo (grandezza) morsa / Vise type (size)	1	2	3	4	5	6
---	---	---	---	---	---	---

**PIASTRE PIANE TEMPRATE, RIGATE O QUADRETTATE**
**HARDENED GROOVED OR SERRATED STRAIGHT JAW PLATES**

 Dotazione normale delle ganasce e delle morse complete  
 Standard equipment on complete jaws and vises

Per qualsiasi piastra ganascia speciale, raddoppiare il prezzo / For special tailor made jaw plate double the price

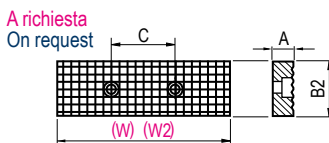
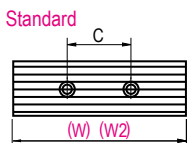
**Art. 242 (W)**
**Art. 242S (W)**

 Per ganascia fissa e mobile - Art. 140, 143, 146 - Larghezza normale (W)  
 For fixed and movable jaw - Art. 140, 143, 146 - Normal width (W)

W	100	125	150	175	200	300
W2	74	94	124	144	169	194
A	12	12	13	13	18	18
B2	24,5	32	40	43	48	56
C	25	32	50	50	76	90

Cod. Art. 242	1.65.16000	1.65.26000	1.65.36000	1.65.46000	1.65.56000	1.65.66000
Cod. Art. 242S	4.24.2S100	4.24.2S200	4.24.2S300	4.24.2S400	4.24.2S500	4.24.2S600

**Art. 243 (W2)**
**Art. 243S (W2)**

 Per ganascia fissa e mobile - Art. 141, 144, 147 - Larghezza ridotta (W2)  
 For fixed and movable jaw - Art. 141, 144, 147 - Narrow width (W2)

Cod. Art. 243	1.65.17000	1.65.27000	1.65.37000	1.65.47000	1.65.57000	1.65.67000
Cod. Art. 243S	4.24.3S100	4.24.3S200	4.24.3S300	4.24.3S400	4.24.3S500	4.24.3S600

**PIASTRE PIANE LISCE TEMPRATE**
**HARDENED SMOOTH STRAIGHT JAW PLATES**

Fornibili a richiesta già montate, a metà prezzo se in aggiunta all'acquisto della morsa

Available on request already mounted, at half price if purchased extra with the vise

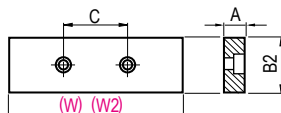
**Art. 244 (W)**

 Per ganascia fissa e mobile - Art. 140, 143, 146 - Larghezza normale (W)  
 For fixed and movable jaw - Art. 140, 143, 146 - Normal width (W)

Cod. Art. 244	4.24.41000	4.24.42000	4.24.43000	4.24.44000	4.24.45000	4.24.46000
---------------	------------	------------	------------	------------	------------	------------

**Art. 245 (W2)**

 Per ganascia fissa e mobile - Art. 141, 144, 147 - Larghezza ridotta (W2)  
 For fixed and movable jaw - Art. 141, 144, 147 - Narrow width (W2)

Cod. Art. 245	4.24.51000	4.24.52000	4.24.53000	4.24.54000	4.24.55000	4.24.56000
---------------	------------	------------	------------	------------	------------	------------

**PIASTRE PIANE IN ACCIAIO LAVORABILE (DOLCE)**
**MACHINEABLE STEEL STRAIGHT JAW PLATES (SOFT HRC)**

Fornibili a richiesta già montate, a metà prezzo se in aggiunta all'acquisto della morsa

Available on request already mounted, at half price if purchased extra with the vise

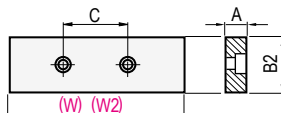
**Art. 246 (W)**

 Per ganascia fissa e mobile - Art. 140, 143, 146 - Larghezza normale (W)  
 For fixed and movable jaw - Art. 140, 143, 146 - Normal width (W)

Cod. Art. 246	1.65.16200	1.65.26200	1.65.36200	1.65.46200	1.65.56200	1.65.66200
---------------	------------	------------	------------	------------	------------	------------

**Art. 247 (W2)**

 Per ganascia fissa e mobile - Art. 141, 144, 147 - Larghezza ridotta (W2)  
 For fixed and movable jaw - Art. 141, 144, 147 - Narrow width (W2)

Cod. Art. 247	1.65.17200	1.65.27200	1.65.37200	1.65.47200	1.65.57200	1.65.67200
---------------	------------	------------	------------	------------	------------	------------

**PIASTRE PIANE TEMPRATE GRIP**
**HARDENED STRAIGHT JAW PLATES GRIP**

Fornibili a richiesta già montate, a metà prezzo se in aggiunta all'acquisto della morsa

Available on request already mounted, at half price if purchased extra with the vise

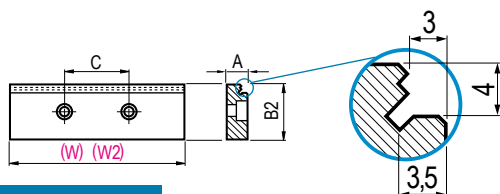
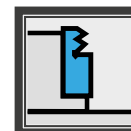
**PIASTRE GANASCE "GRIP" JAW PLATES**
**MINOR SUPERFICIE DI CONTATTO + PRESSIONE DI SERRAGGIO**
**LESS SURFACE CONTACT + CLAMPING PRESSURE**
**Art. 246T (W)**

 Per ganascia fissa e mobile - Art. 140, 143, 146 - Larghezza normale (W)  
 For fixed and movable jaw - Art. 140, 143, 146 - Normal width (W)

Cod. Art. 246T	4.24.6T100	4.24.6T200	4.24.6T300	4.24.6T400	4.24.6T500	4.24.6T600
----------------	------------	------------	------------	------------	------------	------------

**Art. 247T (W2)**

 Per ganascia fissa e mobile - Art. 141, 144, 147 - Larghezza ridotta (W2)  
 For fixed and movable jaw - Art. 141, 144, 147 - Narrow width (W2)

Cod. Art. 247T	4.24.7T100	4.24.7T200	4.24.7T300	4.24.7T400	4.24.7T500	4.24.7T600
----------------	------------	------------	------------	------------	------------	------------

# GANASCE CON PIASTRE PIANE GRIP / STRAIGHT PLATE GRIP JAWS

**Tipo (grandezza) morsa / Vise type (size)**
**NEW**
**Art. 140T W - W3**

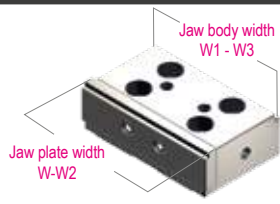
 Ganascia fissa GRIP. **Larghezza normale (W) - (W3)**  
 Fixed GRIP jaw. **Normal width (W) - (W3)**

Cod.	2.14.0T100	2.14.0T200	2.14.0T300	2.14.0T400	2.14.0T500	2.14.0T600
Cod.	2.14.1T100	2.14.1T200	2.14.1T300	2.14.1T400	2.14.1T500	2.14.1T600

**Art. 141T W2 - W1**

 Ganascia fissa GRIP.  
**Larghezza ridotta rettificata (W2) - (W1)**  
 Fixed GRIP jaw. **Narrow width ground (W2) - (W1)**
**Art. 143T W - W3**

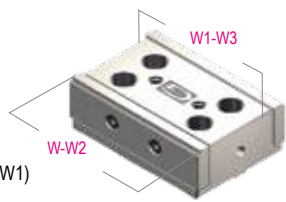
 Ganascia fissa doppia. **Larghezza normale (W) - (W3)**  
 Double fixed jaw. **Normal width (W) - (W3)**

Cod.	2.14.3T100	2.14.3T200	2.14.3T300	2.14.3T400	2.14.3T500	2.14.3T100
Cod.	2.14.4T100	2.14.4T200	2.14.4T300	2.14.4T400	2.14.4T500	2.14.4T600

**Art. 144T W2 - W1**

 Ganascia fissa doppia. **Larghezza ridotta rettificata (W2) - (W1)**  
 Double fixed jaw. **Narrow width ground (W2) - (W1)**
**Art. 146T W - W3**

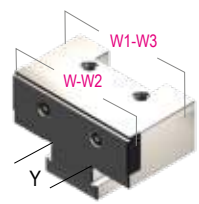
 Ganascia mobile monoblocco guidata.  
**Larghezza normale (W) - (W3)**  
 Guided movable solid jaw. **Normal width (W) - (W3)**

Cod.	2.14.6T100	2.14.6T200	2.14.6T300	2.14.6T400	2.14.6T500	2.14.6T600
Cod.	2.14.7T100	2.14.7T200	2.14.7T300	2.14.7T400	2.14.7T500	2.14.7T600

**Art. 147T W2 - W1**

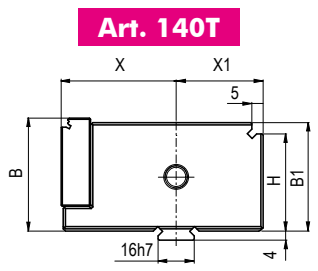
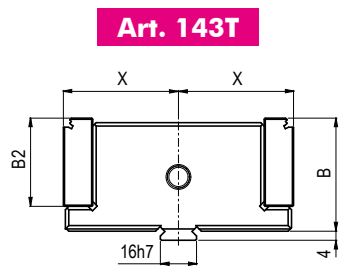
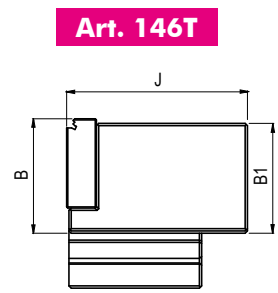
 Ganascia mobile monoblocco guidata.  
**Larghezza ridotta (W2) - (W1)**  
 Guided movable solid jaw. **Narrow width (W2) - (W1)**

**Art. 140T**

**Art. 143T**

**Art. 146T**

\* DIMENSIONE DA ACCOPPIARE AD Art. 212 + 217 + 214 - DIMENSION TO BE MATCHED WITH Art. 212 + 217 + 214

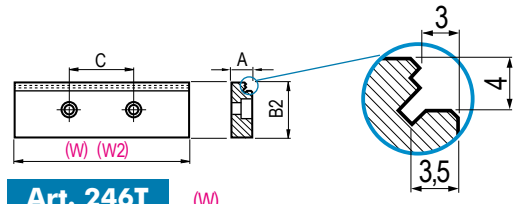
Tipo / Type	1	2	3	4	5	6
W = Jaw plate	100	125	150	175	200	300
W1 = Jaw body	75	95	125	145	170	195
W2 = Jaw plate	74	94	124	144	169	194
W3 = Jaw body	96	121	146	171	196	296
Y	21	28	41	51	61	71
B	30	40	50	60	65	80
B1	28	38	48	58	63	78
B2	24,5	32	40	43	48	63
* H	23	33	43	53	53	68
J	50	60	80	90	100	120
X	42,4	42,4	50,9	55,4	66,4	73,1
X1	35,5	35,5	38,5	41,5	47	47

**PIASTRE PIANE TEMPERATE GRIP**  
**HARDENED STRAIGHT JAW PLATES GRIP**

 Fornibili a richiesta su ganasce e morse senza variazione di prezzo  
 Available on request for complete jaws and vises without price change

**PIASTRE GANASCE "GRIP" JAW PLATES**

**MINOR SUPERFICIE DI CONTATTO + PRESSIONE DI SERRAGGIO**  
**LESS SURFACE CONTACT + CLAMPING PRESSURE**
**Art. 246T (W)**

 Per ganasce fissa e mobile - Art. 140, 143, 146 - Larghezza normale (W)  
 For fixed and movable jaw - Art. 140, 143, 146 - Normal width (W)

Cod. Art. 246T	4.24.6T100	4.24.6T200	4.24.6T300	4.24.6T400	4.24.6T500	4.24.6T600
----------------	------------	------------	------------	------------	------------	------------

**Art. 247T (W2)**

 Per ganasce fissa e mobile - Art. 141, 144, 147 - Larghezza ridotta (W2)  
 For fixed and movable jaw - Art. 141, 144, 147 - Narrow width (W2)

Cod. Art. 247T	4.24.7T100	4.24.7T200	4.24.7T300	4.24.7T400	4.24.7T500	4.24.7T600
----------------	------------	------------	------------	------------	------------	------------

# GANASCE CON PIASTRE CON INSERTI GRIP / STRAIGHT PLATE JAWS WITH GRIP INSERTS

**NEW**

Tipo (grandezza) morsa / Vise type (size)	1	2	3	4	5	6
---	---	---	---	---	---	---

**Art. 140G** W  
 Ganascia fissa completa di parallela magnetica. **Larghezza normale (W)** - (W3)  
 Fixed jaw with magnetic parallel. **Normal width (W)** - (W3)

Cod.	2.14.0G100	2.14.0G200	2.14.0G300	2.14.0G400	2.14.0G500	2.14.0G600
------	------------	------------	------------	------------	------------	------------

**Art. 141G** W2  
 Ganascia fissa completa di parallela magnetica. **Larghezza ridotta rettificata (W2)** - (W1)  
 Fixed jaw complete with magnetic parallel. **Narrow width ground (W2)** - (W1)

Cod.	2.14.1G100	2.14.1G200	2.14.1G300	2.14.1G400	2.14.1G500	2.14.1G600
------	------------	------------	------------	------------	------------	------------

**Art. 143G** W  
 Ganascia fissa doppia completa di parallela magnetica. **Larghezza normale (W)** - (W3)  
 Double fixed jaw complete with magnetic parallel. **Normal width (W)** - (W3)

Cod.	2.14.3G100	2.14.3G200	2.14.3G300	2.14.3G400	2.14.3G500	2.14.3G600
------	------------	------------	------------	------------	------------	------------

**Art. 144G** W2  
 Ganascia fissa doppia completa di parallela magnetica. **Larghezza ridotta rettificata (W2)** - (W1)  
 Double fixed jaw complete with magnetic parallel. **Narrow width ground (W2)** - (W1)

Cod.	2.14.4G100	2.14.4G200	2.14.4G300	2.14.4G400	2.14.4G500	2.14.4G600
------	------------	------------	------------	------------	------------	------------

**Art. 146G** W  
 Ganascia mobile monoblocco guidata completa di parallela magnetica. **Larghezza normale (W)**  
 Guided movable solid jaw. Complete with magnetic parallel. **Normal width (W)**

Cod.	2.14.6G100	2.14.6G200	2.14.6G300	2.14.6G400	2.14.6G500	2.14.6G600
------	------------	------------	------------	------------	------------	------------

**Art. 147G** W2  
 Ganascia mobile monoblocco guidata completa di parallela magnetica. **Larghezza ridotta (W2)**  
 Guided movable solid jaw complete with magnetic parallel. **Narrow width (W2)**

Cod.	2.14.7G100	2.14.7G200	2.14.7G300	2.14.7G400	2.14.7G500	2.14.7G600
------	------------	------------	------------	------------	------------	------------

**Art. 148G** W  
 Ganascia mobile monoblocco oscillante completa di parallela magnetica. **Larghezza normale (W)**  
 Floating movable solid jaw complete with magnetic parallel. **Normal width (W)**

Cod.	2.14.8G100	2.14.8G200	2.14.8G300	2.14.8G400	2.14.8G500	2.14.8G600
------	------------	------------	------------	------------	------------	------------

**Art. 149G** W2  
 Ganascia mobile monoblocco oscillante completa di parallela magnetica. **Larghezza ridotta (W2)**  
 Floating movable solid jaw complete with magnetic parallel. **Narrow width (W2)**

Cod.	2.14.9G100	2.14.9G200	2.14.9G300	2.14.9G400	2.14.9G500	2.14.9G600
------	------------	------------	------------	------------	------------	------------

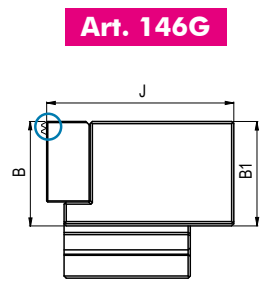
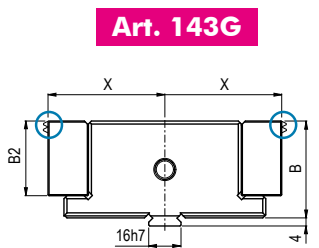
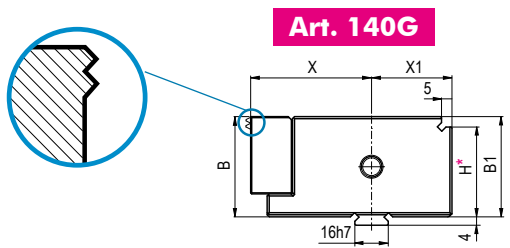

\* DIMENSIONE DA ACCOPPIARE AD Art. 212 + 217 + 214 - DIMENSION TO BE MATCHED WITH Art. 212 + 217 + 214

Tipo / Type	1	2	3	4	5	6
W = Jaw plate	100	125	150	175	200	300
W1 = Jaw body	75	95	125	145	170	195
W2 = Jaw plate	74	94	124	144	169	194
W3 = Jaw body	96	121	146	171	196	296
Y	21	28	41	51	61	71
Y1	20	27	40	50	60	70
B	28	38	48	58	63	78
B1	28	38	48	58	63	78
B2	24,5	30	37	42	46	54
<b>* H</b>	<b>23</b>	<b>33</b>	<b>43</b>	<b>53</b>	<b>53</b>	<b>68</b>
J	58	68	87	97	102	122
X	50,4	50,4	57,9	62,4	68,4	75,1
X1	35,5	35,5	38,5	41,5	47	47

# PIASTRE GANASCE CON INSERTI GRIP E PARALLELA MAGNETICA

**Tipo (grandezza) morsa / Vise type (size)**
**NEW**
**1**
**2**
**3**
**4**
**5**
**6**
**Art. 242G W**

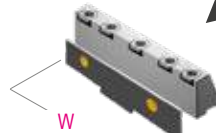
 Piastra Ganascia con Inserti GRIP. **Larghezza normale (W)**  
 Jaw plate with GRIP insert. **Normal width (W)**

Cod. 1.24.2G100 1.24.2G200 1.24.2G300 1.24.2G400 1.24.2G500 1.24.2G600

**ATTENZIONE - ATTENTION:**

Utilizzare solo con viti posteriori ben serrate - Using only with rear screws strong clamped

**Art. 243G W2**

 Piastra Ganascia con Inserti GRIP. **Larghezza ridotta rettificata (W1)**  
 Jaw plate with GRIP insert. **Narrow width ground (W1)**

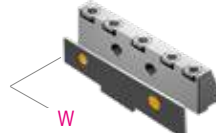

Cod. 1.24.3G100 1.24.3G200 1.24.3G300 1.24.3G400 1.24.3G500 1.24.3G600

**Art. 248G W**

 Piastra Ganascia con Inserti GRIP  
**per ganascia fissa doppia. Larghezza normale (W)**  
 Jaw plate with GRIP insert for double fixed jaw. **Normal width (W)**

Cod. 1.24.8G100 1.24.8G200 1.24.8G300 1.24.8G400 1.24.8G500 1.24.8G600

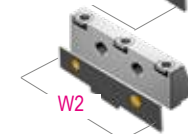
**Art. 249G W2**

 Piastra Ganascia con Inserti GRIP  
**per ganascia fissa doppia. Larghezza ridotta rettificata (W1)**  
 Jaw plate with GRIP insert.  
**For double fixed jaw. Narrow width ground (W1)**

Cod. 1.24.9G100 1.24.9G200 1.24.9G300 1.24.9G400 1.24.9G500 1.24.9G600

**Art. 246G W**

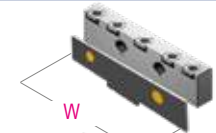
 Piastra Piana con Inserti GRIP. **Larghezza normale (W)**  
 Straight Plate with GRIP inserts. **Normal width (W)**

Cod. 1.24.6G100 1.24.6G200 1.24.6G300 1.24.6G400 1.24.6G500 1.24.6G600

**Art. 247G W2**

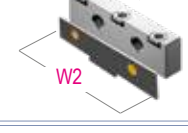
 Piastra Piana con Inserti GRIP. **Larghezza ridotta rettificata (W1)**  
 Straight Plate with GRIP inserts. **Narrow width ground (W1)**

Cod. 1.24.7G100 1.24.7G200 1.24.7G300 1.24.7G400 1.24.7G500 1.24.7G600

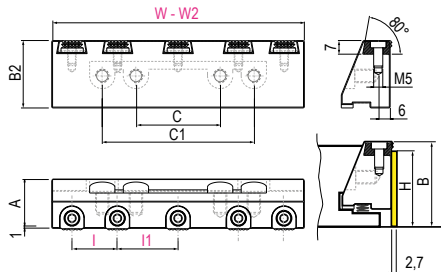
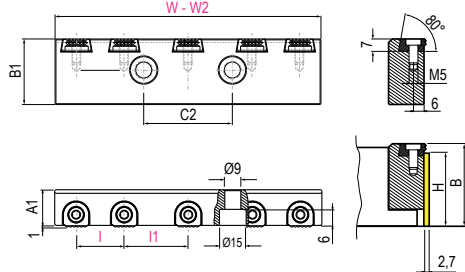
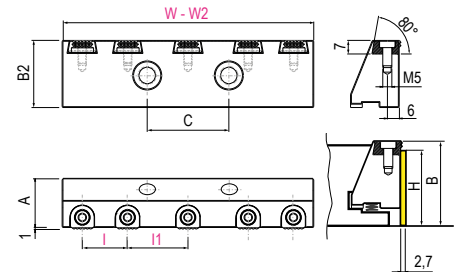
**Art.242G W**

**Art.246G W**

**Art.248G W**

**Dotazione Standard - Standard Equipment**

1 pc. Art.313S (parallela magnetica SINGOLA) - 1 pc. Art.313S (SINGLE magnetic parallel)

Tipo / Type	1	2	3	4	5	6
W	100	125	150	175	200	300
W2	74	94	124	144	169	194
I	-	-	31,5	35	27	33
I1	35	45	31,5	35	27	33
C	20	32	50	50	76	90
C1	62	80	90	116	138	184
C2	25	32	50	50	76	90
B	30	40	50	60	65	80
B1	24,5	32	39	43	48	56
B2	24,5	32	40	43	53	63
A	25	27	29	32	34	43
A1	20	20	20	20	20	20
H	25	35	45	55	60	75

# INSERT GRIP JAW PLATES WITH MAGNETIC PARALLEL

**NEW**

**Art. 242G**

Con parallela magnetica e Inserti GRIP  
With magnetic parallel and GRIP inserts



**Art. 243G**  
Larghezza ridotta  
Narrow width

**Art. 248G** Per ganasca fissa doppia  
For double fixed jaw

Con parallela magnetica e Inserti GRIP  
With magnetic parallel and GRIP inserts



**Art. 249G**  
Larghezza ridotta  
Narrow width

**Art. 246G** Piastra Piana  
Straight Plate

Piana con parallela magnetica e Inserti GRIP  
Straight with magnetic parallel and GRIP inserts



**Art. 247G**  
Larghezza ridotta  
Narrow width

## Inserti Grip - Grip Inserts

**Art. 220 G01**

Per materiali di durezza normale  
For standard workpieces hardness clamping

Cod. 4.22.01000 / G01

**Art. 220 G02**

Per materiali di notevole durezza.  
For hardened workpieces clamping

Cod. 4.22.01000 / G02

**Art. 220 G11**

Per materiali teneri  
For soft material clamping

Cod. 4.22.01000 / G11

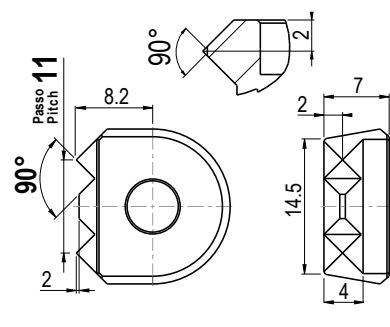
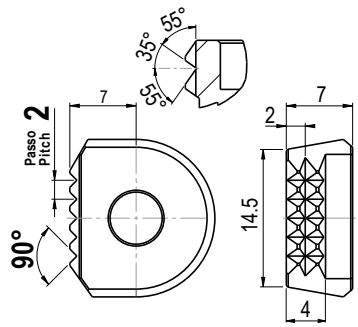
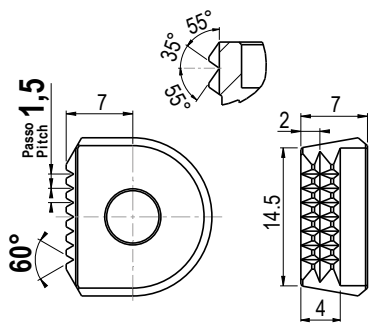

Tipo / Type	1	2	3	4	5	6
Art.242G - Art.248G - Art.246G	3 pcs each jaw plate	3 pcs each jaw plate	5 pcs each jaw plate	5 pcs each jaw plate	7 pcs each jaw plate	9 pcs each jaw plate
Art.243G - Art.249G - Art.247G	3 pcs each jaw plate	3 pcs each jaw plate	5 pcs each jaw plate	5 pcs each jaw plate	7 pcs each jaw plate	7 pcs each jaw plate
Viti a testa bassa M5 x 10mm Low head screws M5 x 10mm	3 pcs each	3 pcs each	5 pcs each	5 pcs each	7 pcs each	7 / 9 pcs each

Tipo (grandezza) morsa / Vise type (size)	1	2	3	4	5	6
---	---	---	---	---	---	---

**Art.220F**

Utensile fresa per realizzare sedi per inserti grip su piastre ganasce dolci  
Milling tool for machining the insert grip seat on machineable jaw plates

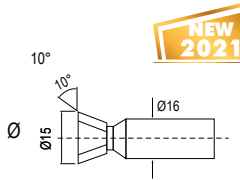

**NEW 2021**

Ø	15					
Cod.	4.22.0F1510					

# PIASTRE GANASCE A GRADINO INTEGRALE CON INSERTI GRIP

**Tipo (grandezza) morsa / Vise type (size)**
**NEW 2021**

1	2	3	4	5	6
---	---	---	---	---	---

**Art. 242K W**

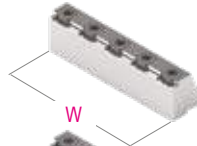
 Piastra Ganascia a gradino con Inserti GRIP.  
**Larghezza normale (W)**  
 Step jaw plate with GRIP insert. **Normal width (W)**

Cod.	1.24.2K100	1.24.2K200	1.24.2K300	1.24.2K400	1.24.2K500	1.24.2K600
------	------------	------------	------------	------------	------------	------------

**Art. 243K W2**

 Piastra Ganascia a gradino con Inserti GRIP.  
**Larghezza ridotta rettificata (W1)**  
 Step jaw plate with GRIP insert. **Narrow width ground (W1)**

**ATTENZIONE - ATTENTION:**

Utilizzare solo con viti posteriori ben serrate - Using only with rear screws strong clamped

Cod.	1.24.3K100	1.24.3K200	1.24.3K300	1.24.3K400	1.24.3K500	1.24.3K600
------	------------	------------	------------	------------	------------	------------

**Art. 248K W**

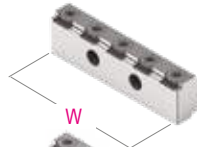
 Piastra Ganascia a gradino con Inserti GRIP  
**per ganascia fissa doppia. Larghezza normale (W)**  
 Jaw plate with GRIP insert for double fixed jaw. **Normal width (W)**

Cod.	1.24.8K100	1.24.8K200	1.24.8K300	1.24.8K400	1.24.8K500	1.24.8K600
------	------------	------------	------------	------------	------------	------------

**Art. 249K W2**

 Piastra Ganascia a gradino con Inserti GRIP  
**per ganascia fissa doppia. Larghezza ridotta rettificata (W1)**  
 Step jaw plate with GRIP insert.  
**For double fixed jaw. Narrow width ground (W1)**

Cod.	1.24.9K100	1.24.9K200	1.24.9K300	1.24.9K400	1.24.9K500	1.24.9K600
------	------------	------------	------------	------------	------------	------------

**Art. 246K W**

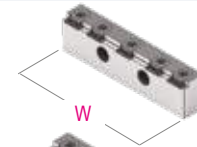
 Piastra Piana con Inserti GRIP. **Larghezza normale (W)**  
 Straight Plate with GRIP inserts. **Normal width (W)**

Cod.	1.24.6K100	1.24.6K200	1.24.6K300	1.24.6K400	1.24.6K500	1.24.6K600
------	------------	------------	------------	------------	------------	------------

**Art. 247K W2**

 Piastra Piana con Inserti GRIP. **Larghezza ridotta rettificata (W1)**  
 Straight Plate with GRIP inserts. **Narrow width ground (W1)**

Cod.	1.24.7K100	1.24.7K200	1.24.7K300	1.24.7K400	1.24.7K500	1.24.7K600
------	------------	------------	------------	------------	------------	------------

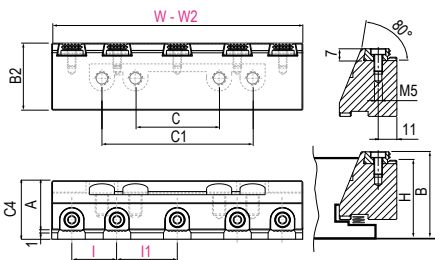
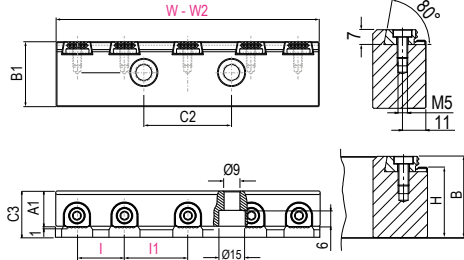
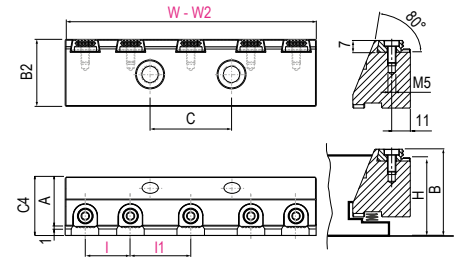
**Art. 242K W**

**Art. 247K W**

**Art. 248K W**

Tipo / Type	1	2	3	4	5	6
W	100	125	150	175	200	300
W2	74	94	124	144	169	194
I	-	-	31,5	35	27	33
I1	35	45	31,5	35	27	33
C	20	32	50	50	76	90
C1	62	80	90	116	138	184
C2	25	32	50	50	76	90
C3	25	25	25	25	25	25
C4	30	32	34	37	39	48
B	30	40	50	60	65	80
B1	24,5	32	39	43	48	56
B2	24,5	32	40	43	53	63
A	25	27	29	32	34	43
A1	20	20	20	20	20	20
H	25	35	45	55	60	75



# INTEGRAL INSERT GRIP STEP JAW PLATES

**NEW 2021**

**Art. 242K**   
A gradino con Inserti GRIP  
With step and GRIP inserts



**Art. 248K**   
Per ganasce fissa doppia  
For double fixed jaw  
A gradino con Inserti GRIP  
With step and GRIP inserts



**Art. 246K**   
Piastra Piana  
Straight Plate  
A gradino con Inserti GRIP  
With step and GRIP inserts



**Art. 243K**  
Larghezza ridotta  
Narrow width



**Art. 249K**  
Larghezza ridotta  
Narrow width



**Art. 247K**  
Larghezza ridotta  
Narrow width

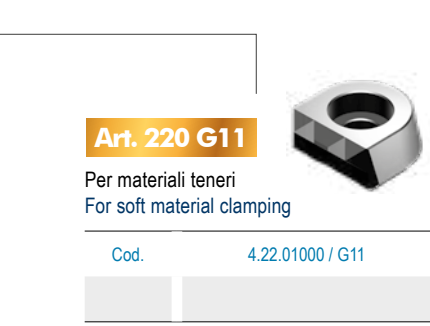

## Inserti Grip - Grip Inserts

**Art. 220 G01**   
Per materiali di durezza normale  
For standard workpieces hardness clamping

Cod. 4.22.01000 / G01









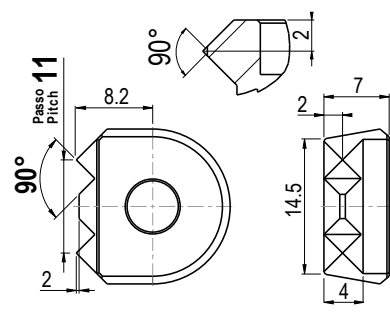
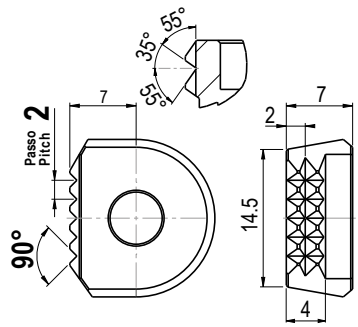
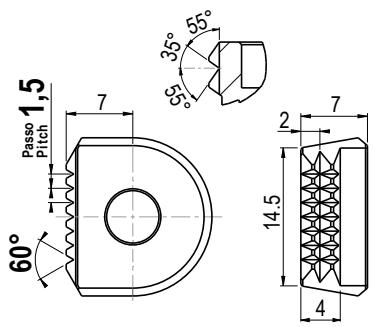











**Art. 220 G02**   
Per materiali di notevole durezza.  
For hardened workpieces clamping

Cod. 4.22.01000 / G02

**Art. 220 G11**   
Per materiali teneri  
For soft material clamping

Cod. 4.22.01000 / G11



Tipo / Type	1	2	3	4	5	6
 Art.242K - Art.248K - Art.246K	 3 pcs each jaw plate	 3 pcs each jaw plate	 5 pcs each jaw plate	 5 pcs each jaw plate	 7 pcs each jaw plate	 9 pcs each jaw plate
 Art.243K - Art.249K - Art.247K	 3 pcs each jaw plate	 3 pcs each jaw plate	 5 pcs each jaw plate	 5 pcs each jaw plate	 7 pcs each jaw plate	 7 pcs each jaw plate
Viti a testa bassa M5 x 10mm Low head screws M5 x 10mm	 3 pcs each	 3 pcs each	 5 pcs each	 5 pcs each	 7 pcs each	 7 / 9 pcs each

Tipo (grandezza) morsa / Vise type (size)	1	2	3	4	5	6
---	---	---	---	---	---	---

**Art.220F**   
Utensile fresa per realizzare sedi per inserti grip su piastre ganasce dolci  
Milling tool for machining the insert grip seat on machineable jaw plates

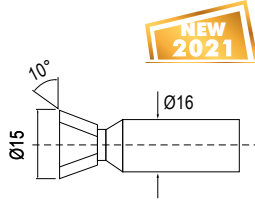

Ø	15					
Cod.	4.22.0F1510					

**GANASCE LAVORABILI MONOBLOCCO / SOLID MACHINEABLE JAWS**

Tipo (grandezza) morsa / Vise type (size)	1	2	3	4	5	6
<b>Art. 160</b> W3 Ganasca fissa. Larghezza normale (W3) Fixed jaw. Normal width (W3)	Cod. 2.16.01000	2.16.02000	2.16.03000	2.16.04000	2.16.05000	2.16.06000
<b>Art. 161</b> W1 Ganasca fissa. Larghezza ridotta rettificata (W1) Fixed jaw. Narrow width ground (W1)	Cod. 2.16.11000	2.16.12000	2.16.13000	2.16.14000	2.16.15000	2.16.16000
<b>Art. 163</b> W3 Ganasca fissa doppia. Larghezza normale (W3) Double fixed jaw. Normal width (W3)	Cod. 2.16.31000	2.16.32000	2.16.33000	2.16.34000	2.16.35000	2.16.36000
<b>Art. 164</b> W1 Ganasca fissa doppia. Larghezza ridotta rettificata (W1) Double fixed jaw. Narrow width ground (W1)	Cod. 2.16.41000	2.16.42000	2.16.43000	2.16.44000	2.16.45000	2.16.46000
<b>Art. 166</b> W3 Ganasca mobile monoblocco guidata. Larghezza normale (W3) Guided movable solid jaw. Normal width (W3)	Cod. 2.16.61000	2.16.62000	2.16.63000	2.16.64000	2.16.65000	2.16.66000
<b>Art. 167</b> W2 Ganasca mobile monoblocco guidata. Larghezza ridotta (W2) Guided movable solid jaw. Narrow width (W2)	Cod. 2.16.71000	2.16.72000	2.16.73000	2.16.74000	2.16.75000	2.16.76000
<b>Art. 168</b> W3 Ganasca mobile monoblocco oscillante. Larghezza normale (W3) Floating movable solid jaw. Normal width (W3)	Cod. 2.16.81000	2.16.82000	2.16.83000	2.16.84000	2.16.85000	2.16.86000
<b>Art. 169</b> W2 Ganasca mobile monoblocco oscillante. Larghezza ridotta (W2) Floating movable solid jaw. Narrow width (W2)	Cod. 2.16.91000	2.16.92000	2.16.93000	2.16.94000	2.16.95000	2.16.96000

**Durezza / Hardness HB= 290**

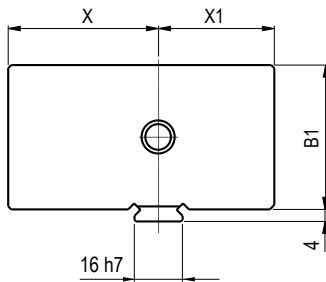
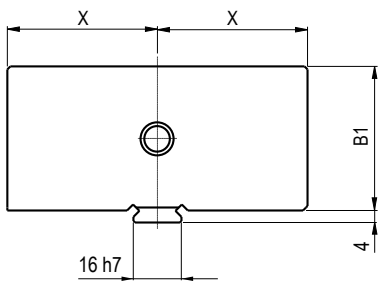
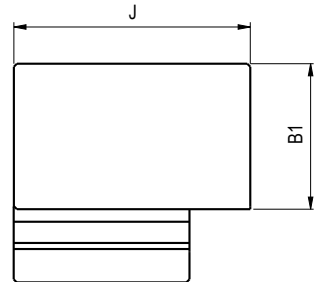
**Art. 160**

**Art. 163**

**Art. 166**

Art.	1	2	3	4	5	6
W3	96	121	146	171	196	296
W1	75	95	125	145	170	195
W2	74	94	124	144	169	194
B1	28	38	48	58	63	78
Y	21	28	41	51	61	71
Y-1	20	27	40	50	60	70
J	50	60	80	90	100	120
X	42,4	42,4	50,9	55,4	66,4	73,1
X1	35,5	35,5	36,5	41,5	47	47

**GANASCE MONOBLOCCO TEMPRATE CON GRADINO / SOLID JAWS WITH STEP, CASE HARDENED**

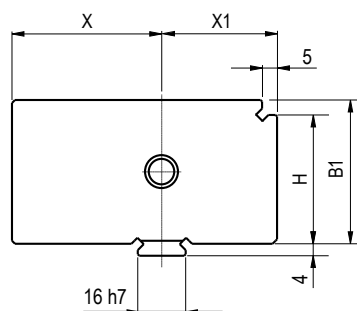
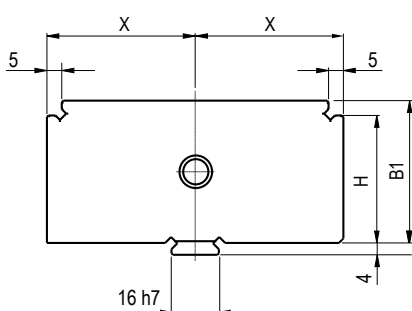
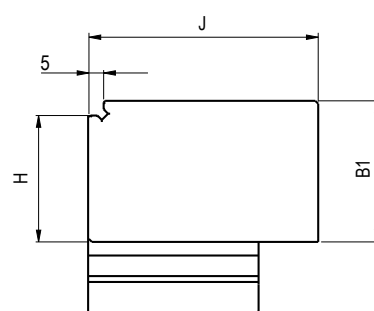
Tipo (grandezza) morsa / Vise type (size)		1	2	3	4	5	6	
<b>Art. 200</b> W3 Ganascia fissa. Larghezza normale (W3) Fixed jaw. Normal width (W3)		Cod.	2.20.01000	2.20.02000	2.20.03000	2.20.04000	2.20.05000	2.20.06000
<b>Art. 201</b> W1 Ganascia fissa. Larghezza ridotta rettificata (W1) Fixed jaw. Narrow width ground (W1)		Cod.	2.20.11000	2.20.12000	2.20.13000	2.20.14000	2.20.15000	2.20.16000
<b>Art. 203</b> W3 Ganascia fissa doppia. Larghezza normale (W3) Double fixed jaw. Normal width (W3)		Cod.	2.20.31000	2.20.32000	2.20.33000	2.20.34000	2.20.35000	2.20.36000
<b>Art. 204</b> W1 Ganascia fissa doppia. Larghezza ridotta rettificata (W1) Double fixed jaw. Narrow width ground (W1)		Cod.	2.20.41000	2.20.42000	2.20.43000	2.20.44000	2.20.45000	2.20.46000
<b>Art. 208</b> W3 Ganascia mobile monoblocco guidata. Larghezza normale (W3) Guided movable solid jaw. Normal width (W3)		Cod.	2.20.81000	2.20.82000	2.20.83000	2.20.84000	2.20.85000	2.20.86000
<b>Art. 209</b> W2 Ganascia mobile monoblocco guidata. Larghezza ridotta (W2) Guided movable solid jaw. Narrow width (W2)		Cod.	2.20.91000	2.20.92000	2.20.93000	2.20.94000	2.20.95000	2.20.96000
<b>Art. 206</b> W3 Ganascia mobile monoblocco oscillante. Larghezza normale (W3) Floating movable solid jaw. Normal width (W3)		Cod.	2.20.61000	2.20.62000	2.20.63000	2.20.64000	2.20.65000	2.20.66000
<b>Art. 207</b> W2 Ganascia mobile monoblocco oscillante. Larghezza ridotta (W2) Floating movable solid jaw. Narrow width (W2)		Cod.	2.20.71000	2.20.72000	2.20.73000	2.20.74000	2.20.75000	2.20.76000

**Durezza / Hardness HRC= 60**

**Art. 200**

**Art. 203**

**Art. 208**

Art.	1	2	3	4	5	6
W3	96	121	146	171	196	296
W1	75	95	125	145	170	195
W2	74	94	124	144	169	194
Y	21	28	41	51	61	71
Y-1	20	27	40	50	60	70
B1	28	38	48	58	63	78
* H	23	33	43	53	53	68
J	50	60	80	90	100	120
X	42,4	42,4	50,9	55,4	66,4	73,1
X1	35,5	35,5	38,5	41,5	47	47

\* DIMENSIONE DA ACCOPPIARE AD Art. 212 + 217 + 214 - DIMENSION TO BE MATCHED WITH Art. 212 + 217 + 214

# Piastra ganascia StdFLEX a cambio rapido / StdFLEX quick change jaw plates

Tipo (grandezza) morsa / Vise type (size)	1	2	3	4	5	6
---	---	---	---	---	---	---

## Art. 120A

Ganascia fissa  
Fixed jaw



Cod.	4.12.0A100	4.12.0A200	4.12.0A300	4.12.0A400	4.12.0A500	4.12.0A600

## Art. 123A

Ganascia fissa doppia  
Double fixed jaw

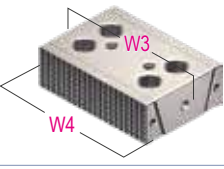

Cod.	4.12.3A100	4.12.3A200	4.12.3A300	4.12.3A400	4.12.3A500	4.12.3A600

## Art. 126A

Ganascia mobile oscillante  
Floating movable jaw

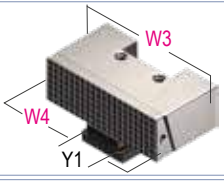

Cod.	4.12.6A100	4.12.6A200	4.12.6A300	4.12.6A400	4.12.6A500	4.12.6A600

## Art. 127A

Ganascia mobile guidata  
Guided movable jaw



Cod.	4.12.7A100	4.12.7A200	4.12.7A300	4.12.7A400	4.12.7A500	4.12.7A600

## Art. 120A

**Durezza / Hardnes HRC= 60**

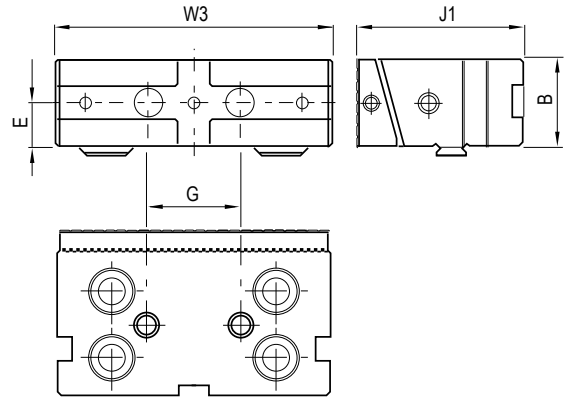

**Ganacce StandardFLEX con piastre intercambiabili manualmente (Sistema a pettine)**  
**StandardFLEX jaws with interchangeable jaw plates by hand (Comb system)**



## Art. 127A

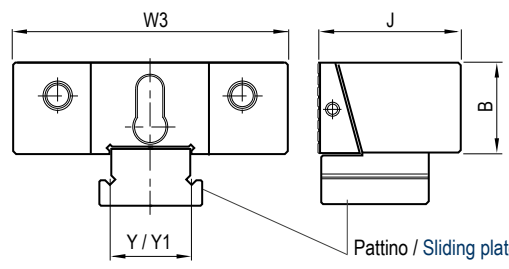

La ganascia mobile guidata, Art. 127A, può essere tramutata in ganascia mobile oscillante, sostituendo il pattino, Art. 306B, con il pattino Art. 306C (vedi pag. 4.30)  
 The guided movable jaw, Art. 127A, could be transformed in a floating movable jaw by simply exchanging the sliding plate, Art. 306B, with sliding plate Art. 306C (see page 4.30)

mm	1	2	3	4	5	6
W3	96	121	146	171	196	296
W4	95	120	145	170	195	295
B	28	38	48	58	63	78
E	14	19	25	27	30	47
G	-	-	50	50	50	50
J	50	60	80	90	100	120
J1	77,9	77,9	89,4	96,9	113,4	120,4
Y	21	28	41	51	61	71
Y1	20	27	40	50	60	70

# Piastre ganascia StdFLEX a cambio rapido / StdFLEX quick change jaw plates

Tipo (grandezza) morsa / Vise type (size)	1	2	3	4	5	6		
<b>Piastre ganascia rapide singole.</b> Ricambi per ganascie rapide a pettine <b>Single quick change jaw plates.</b> Spares for quick change comb jaw								
	W4	95	120	145	170	195	295	
	B	28	38	48	58	63	78	
	C	9	9	11	11	14	14	
<b>Art. 230B</b> Piastra ganascia intercambiabile dolce a pettine Soft comb interchangeable jaw plate								
	Cod.	4.23.0B101	4.23.0B201	4.23.0B301	4.23.0B401	4.23.0B501	4.23.0B601	
<b>Art. 230C</b> Piastra ganascia intercambiabile liscia a pettine Smooth comb interchangeable jaw plate								
	Cod.	4.23.0C101	4.23.0C201	4.23.0C301	4.23.0C401	4.23.0C501	4.23.0C601	
<b>Art. 230D</b> Piastra ganascia intercambiabile zigrinata a pettine Serrated comb interchangeable jaw plate								
	Cod.	4.23.0D101	4.23.0D201	4.23.0D301	4.23.0D401	4.23.0D501	4.23.0D601	
<b>Art. 230SLD</b> Piastra ganascia scaricata a pettine Discharged comb jaw plate			Per il serraggio di particolari di piccole dimensioni utilizzare sempre ganascie scaricate To clamp small workpieces use discharged jaws					
	A	28	38	48	58	63	95	
	B	12	12	12	12	12	12	
	C	14	18	32	42	47	79	
	H	8	8	8	8	8	8	
	Cod.	4.23.0SLD101	4.23.0SLD201	4.23.0SLD301	4.23.0SLD401	4.23.0SLD501	4.23.0SLD601	
<b>Art. 230SLE</b> Piastra ganascia con gradino scaricata a pettine Discharged step comb jaw plate								
	Cod.	4.23.0SLE101	4.23.0SLE201	4.23.0SLE301	4.23.0SLE401	4.23.0SLE501	4.23.0SLE601	
<b>Art. 230K</b> Piastra ganascia intercambiabile a gradino a pettine con inserti GRIP Comb interchangeable step jaw plate with GRIP inserts								
	C	14	18	32	42	47	79	
	H	23	33	43	53	58	73	
	H1	5	5	5	5	5	5	
	Cod.	4.23.0K100	4.23.0K200	4.23.0K300	4.23.0K400	4.23.0K500	4.23.0K600	
<b>Art. 230F</b> Piastra ganascia intercambiabile prismatica a pettine Prismatic comb interchangeable jaw plate			Ø min / max Ø min / max					
	A	6 / 16	9 / 24	13 / 38	15 / 40	15 / 42	15 / 42	
	B	4 / 10	7 / 18	9 / 24	9 / 24	9 / 24	9 / 24	
	Cod.	4.23.0F101	4.23.0F201	4.23.0F301	4.23.0F401	4.23.0F501	4.23.0F601	
<b>Art. 230G</b> Piastra ganascia intercambiabile a pettine con arresto a 90° 90° interchangeable comb jaw plate			<b>Solo 1 per morsa !! Just 1 pc each vise !!</b>					
	Cod.	4.23.0G101	4.23.0G201	4.23.0G301	4.23.0G401	4.23.0G501	4.23.0G601	
<b>Art. 230H</b> Piastra ganascia intercambiabile bombata a pettine Round comb interchangeable jaw plate			<b>Solo 1 per morsa !! Just 1 pc each vise !!</b>					
	Cod.	4.23.0H101	4.23.0H201	4.23.0H301	4.23.0H401	4.23.0H501	4.23.0H601	
<b>Art. 230M</b> Piastra ganascia intercambiabile a pettine per angolo di 30° o 45° 30° or 45° angle interchangeable comb jaw plate			<b>Solo 1 per morsa !! Just 1 pc each vise !!</b>					
	Cod.	4.23.0M101	4.23.0M201	4.23.0M301	4.23.0M401	4.23.0M501	4.23.0M601	
<b>Art. 230L</b> Piastra ganascia intercambiabile a pettine con inserti GRIP frontali GRIP frontal inserts interchangeable comb jaw plate								
	Cod.	4.23.0L101	4.23.0L201	4.23.0L301	4.23.0L401	4.23.0L501	4.23.0L601	

# GANASCE StdFLEX A CAMBIO RAPIDO / StdFLEX QUICK CHANGE JAWS

Tipo (grandezza) morsa / Vise type (size)	1	2	3	4	5	6
<b>Art. 230E</b>						
W	95	120	145	170	195	295
B	28	38	48	58	63	78
	3	3	3	3	3	3
	5	5	5	5	5	5
	8	8	8	8	10	10
<b>H1</b>	13	13	13	13	13	13
	-	18	18	18	18	18
	-	23	23	23	23	23
	-	-	28	28	28	28
<b>SPECIFICARE SEMPRE QUOTA "H1" - ALWAYS SPECIFY "H1" DIMENSION</b>						
Cod.	4.23.0E101	4.23.0E201	4.23.0E301	4.23.0E401	4.23.0E501	4.23.0E601

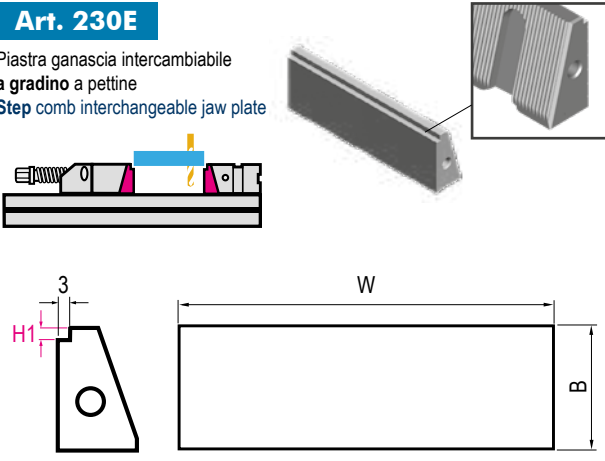

## SET RISPARMIO FINO AL 48% - SAVING UP WITH THE SET 48%

Acquistando i seguenti set di piastre ganasce  
If you purchase this number of jaw plate sets

Set	8	12	14	14	14	14
	Pezzi - Pieces	Pezzi - Pieces	Pezzi - Pieces	Pezzi - Pieces	Pezzi - Pieces	Pezzi - Pieces
Prezzo Cad. se acquistate con set Price each in case of set purchase						

### Art. 320

Portapiastre  
Rack



Cod.	4.32.01000	4.32.02000	4.32.03000	4.32.04000	4.32.05000	4.32.06000

**Risparmio del 33% sul raccogliatore Art.320 (vuoto) se acquistato insieme ad un set di piastre ganasce Art.230A**  
**Save 33% purchasing the rack Art.320 together with the small or big set of straight magnetic parallels plates Art.230E**

### Art. 605G1

Vite a gradino / Step screw



Cod.	6.60.5G101

### Art. 605G2

Perno a molla / Spring pin



Cod.	6.60.5G201	6.60.5G202

### Art. 605G3

Molla / Spring



Cod.	6.60.5G301

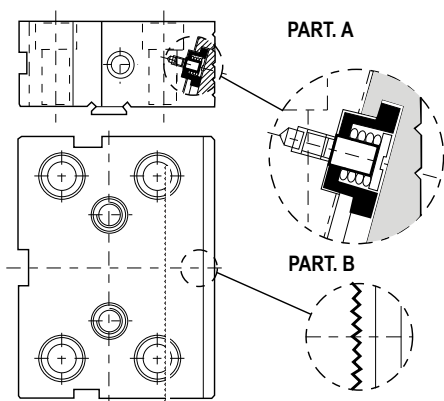

### Rapida sostituzione delle piastre ganasce discendenti senza bisogno di alcun utensile

Il nuovo sistema con piastre ganasce intercambiabili, conferisce alla morsa STD un ulteriore aumento di versatilità dato dalla rapidità di sostituzione delle piastre ganasce e dalla precisione di riposizionamento. La rapidità di sostituzione delle piastre ganasce è resa possibile dal nuovo sistema con perno a molla (PART. A), mentre le righe prismatiche (PART. B) effettuate con mola sagomata sui piani d'appoggio rendono possibile un riposizionamento di elevata precisione.

### Quick hand change of downward jaw plates - no tools needed

The new system with quick interchangeable jaw plates increases the STD vise versatility, and allows the quick jaw allows plates replacement and their high precision repositioning. The speed of the jaw replacement is allowed by the new design of pin with spring (PART. A), while the prismatic grooves (PART. B), made with shaped grind wheel on the surface plates, allow a perfect repositioning. The wide range of interchangeable jaw plates can satisfy the most varied workholding needs.

# GANASCE MOBILI INTERMEDIE / INTERMEDIATE MOVABLE JAWS

**Tipo (grandezza) morsa / Vise type (size)**
**1      2      3      4      5      6**
**Art. 212      W3**

 Ganasce mobile intermedia con doppio gradino.  
 Larghezza normale (W3)

 Intermediate movable jaw with double step.  
 Normal width (W3)

Cod. 1.21.21000    1.21.22000    1.21.23000    1.21.24000    1.21.25000    1.21.26000

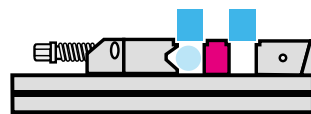
**Art. 213      W2**

 Ganasce mobile intermedia con doppio gradino.  
 Larghezza ridotta (W2)

 Intermediate movable jaw with double step.  
 Narrow width (W2)

Cod. 1.21.31000    1.21.32000    1.21.33000    1.21.34000    1.21.35000    1.21.36000

**Art. 214      W3**

 Ganasce mobile intermedia prismatica.  
 Larghezza normale (W3)

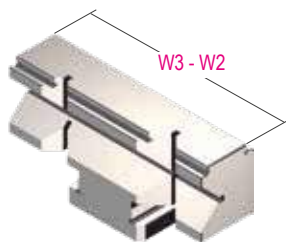
 Prismatic intermediate movable jaw.  
 Normal width (W3)

Cod. 1.21.41000    1.21.42000    1.21.43000    1.21.44000    1.21.45000    1.21.46000

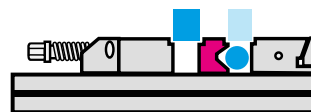
**Art. 215      W2**

 Ganasce mobile intermedia.  
 Larghezza ridotta (W2)

 Intermediate movable jaw.  
 Narrow width (W2)

Cod. 1.21.51000    1.21.52000    1.21.53000    1.21.54000    1.21.55000    1.21.56000

**Art. 224      W3**

 Ganasce mobile intermedia.  
 Larghezza normale (W3)

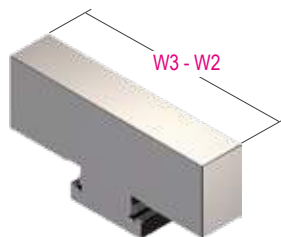
 Intermediate movable jaw.  
 Normal width (W3)

Cod. 1.22.41000    1.22.42000    1.22.43000    1.22.44000    1.22.45000    1.22.46000

**Art. 225      W2**

 Ganasce mobile intermedia.  
 Larghezza ridotta (W2)

 Intermediate movable jaw.  
 Narrow width (W2)

Cod. 1.22.51000    1.22.52000    1.22.53000    1.22.54000    1.22.55000    1.22.56000

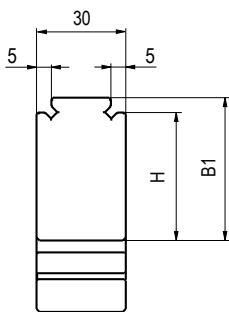
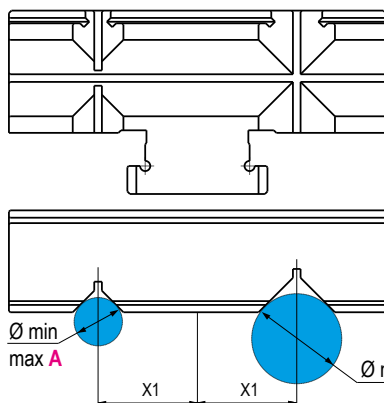
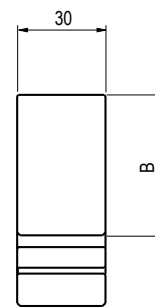
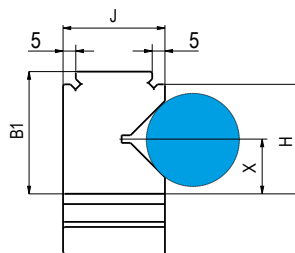
**Art. 212**

**Art. 214**

**Art. 224**

Art.	1	2	3	4	5	6
W3	96	121	146	171	196	296
W2	74	94	124	144	169	194
B	30	40	50	60	65	80
B1	28	38	48	58	63	78
H	23	33	43	53	53	68
J	30	30	40	40	45	50
X	11,5	16,5	21,5	26,5	26,5	34
X1	25	33	39	50	55	70
Ø min/max A	4 - 10	7 - 18	9 - 24	9 - 24	9 - 24	10 - 28
Ø min/max B	6 - 16	9 - 24	13 - 38	15 - 40	15 - 42	18 - 46

## GANASCE MOBILI PRISMATICHE / PRISMATIC MOVABLE JAWS

Tipo (grandezza) morsa / Vise type (size)	1	2	3	4	5	6
<b>Art. 217</b> W3 Ganascia mobile guidata prismatica. Larghezza normale (W3) Prismatic guided movable jaw. Normal width (W3)	Cod. 2.21.71000	2.21.72000	2.21.73000	2.21.74000	2.21.75000	2.21.76000
<b>Art. 218</b> W2 Ganascia mobile guidata prismatica. Larghezza ridotta (W2) Prismatic guided movable jaw. Narrow width (W2)	Cod. 2.21.81000	2.21.82000	2.21.83000	2.21.84000	2.21.85000	2.21.86000
<b>Art. 152</b> W2 Inserto prismatico. Larghezza ridotta (W2) Prismatic insert. Narrow width (W2)	Cod. 4.15.21000	4.15.22000	4.15.23000	4.15.24000	4.15.25000	4.15.26000

## Ganasce per PARTICOLARI TONDI / Jaws for ROUND WORKPIECE

<b>Art. 210</b> W3 Ganascia mobile oscillante. Larghezza normale (W3) Floating movable jaw. Normal width (W3)	Cod. 2.21.01000	2.21.02000	2.21.03000	2.21.04000	2.21.05000	2.21.06000
<b>Art. 211</b> W2 Ganascia mobile oscillante. Larghezza ridotta (W2) Floating movable jaw. Narrow width (W2)	Cod. 2.21.11000	2.21.12000	2.21.13000	2.21.14000	2.21.15000	2.21.16000

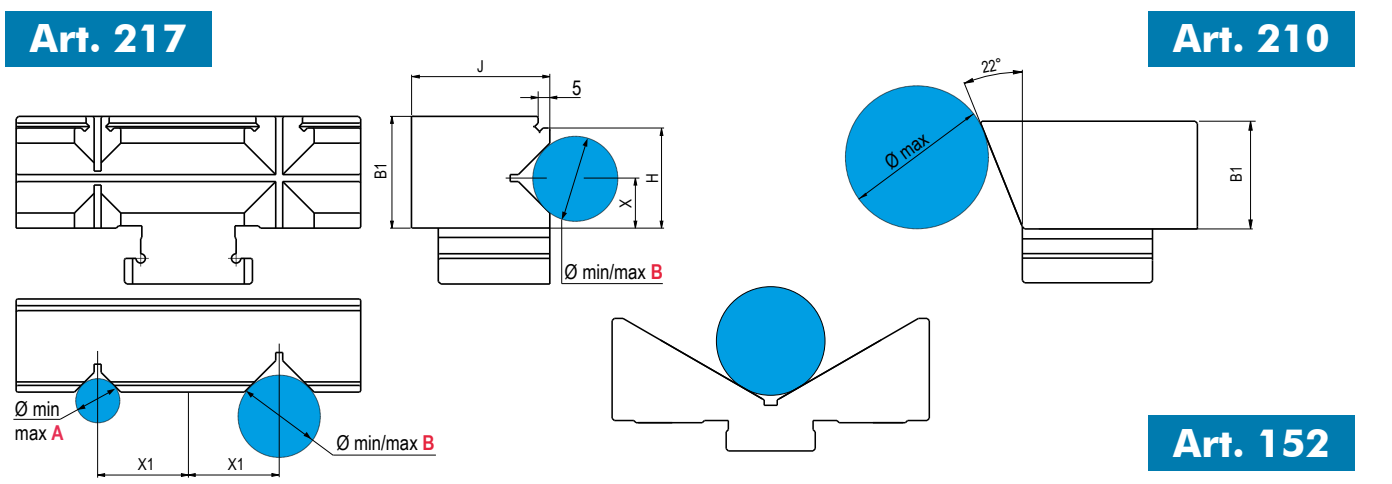

mm	1	2	3	4	5	6
W3	96	121	146	171	196	296
W2	74	94	124	144	169	194
B1	28	38	48	58	63	78
H	23	33	43	53	53	68
J	50	60	80	90	100	120
X	11,5	16,5	21,5	26,5	31,5	34
X1	25	33	39	50	50	70
Ø min / max A Art. 217	4 - 10	7 - 18	9 - 24	9 - 24	9 - 24	10 - 28
Ø min / max B Art. 217	6 - 16	9 - 24	13 - 38	15 - 40	15 - 42	18 - 46
Ø min / max Art. 152			<b>A richiesta</b>	<b>On request</b>		
Ø max Art. 210	35	50	65	80	85	105



# GANASCE CON SEGMENTI OSCILLANTI / MOVABLE JAW WITH FLOATING ELEMENTS

Tipo (grandezza) morsa / Vise type (size)	1	2	3	4	5	6
---	---	---	---	---	---	---

## Art. 192

Ganascia mobile oscillante con 2 segmenti oscillanti e puntali sferici lisci.  
 Floating movable jaw with two floating elements and spherical smooth points.

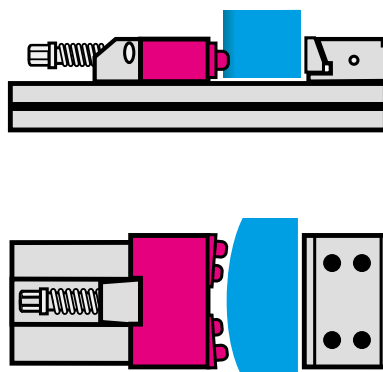
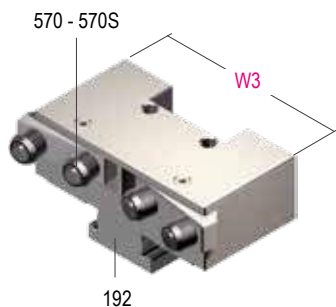

## Art. 192S

Ganascia mobile oscillante con 2 elementi oscillanti e puntali sferici zigrinati.  
 Floating movable jaw with two floating elements and spherical serrated points.

Per serraggio di particolari irregolari - For irregular workpieces clamping

Cod.	4.19.21000	4.19.22000	4.19.23000	4.19.24000	4.19.25000	4.19.26000
Cod.	4.19.2S100	4.19.2S200	4.19.2S300	4.19.2S400	4.19.2S500	4.19.2S600

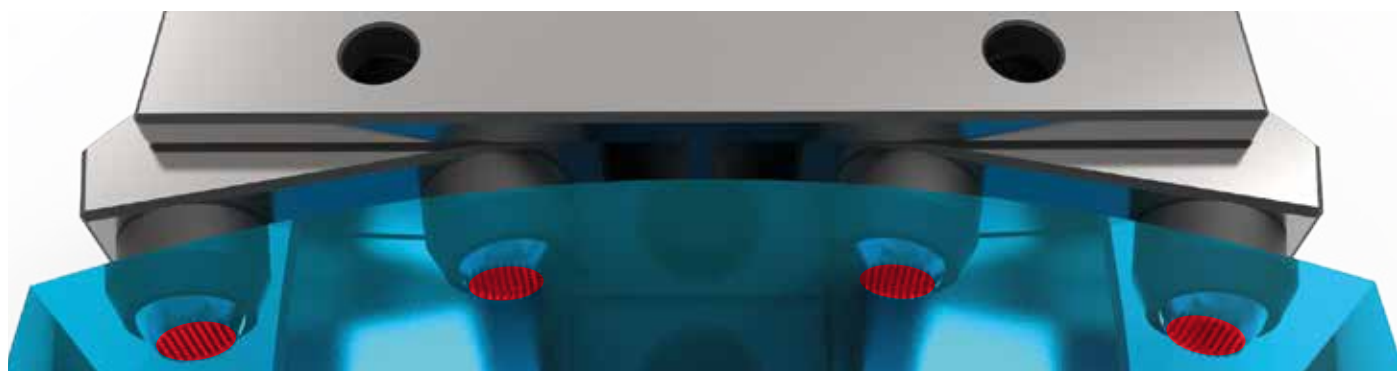

## Art. 192

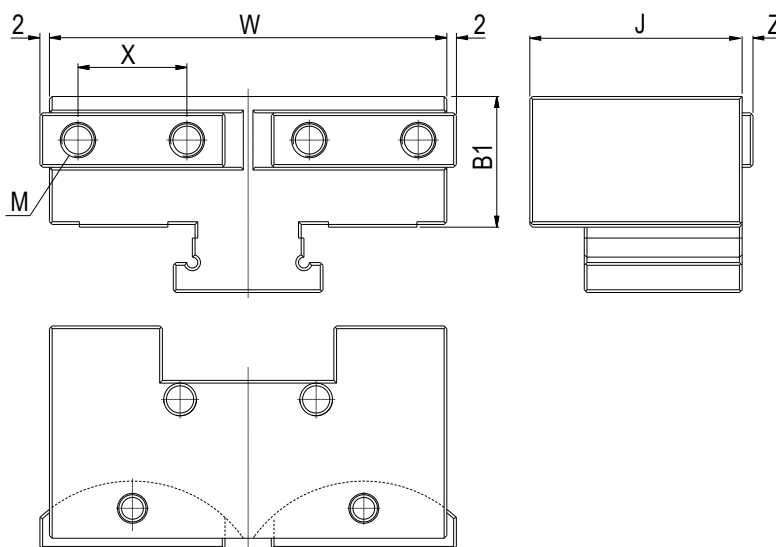

Art.	1	2	3	4	5	6
W3	96	121	146	171	196	296
J	48	58	78	88	98	118
B1	28	38	48	58	63	78
X	30	40	40	40	60	60
M	M10	M12	M12	M12	M16	M16
N	4	4	6	7	8	12
Z	3	4	4	4	7	7

## PARALLELE MODULARI MAGNETICHE AD INNESTO RAPIDO QUICK MAGNETIC MODULAR PARALLEL PLATES

Queste piastre d'appoggio modulari parallele sono una ulteriore opportunita' del sistema modulare Gerardi. Esso consente infatti il posizionamento rapido e preciso di parallele piane o angolari per la lavorazione di pezzi piatti da forare e/o filettare.

**Nessun problema di magnetismo sui trucioli**

The modular bearing parallelsplates are a further opportunity of the Gerardi modular system. It allows in fact the quick and accurate positioning of straight or angular parallels plates to machine (milling, drilling and tapping) flat pieces of any size and dimension without disassembling or positioning the fixture again.

**No problem with chips magnetic**

### VANTAGGI:

- Rapidita' e precisione di installazione.
  - Risparmio rispetto alla sostituzione della ganaschia intera.
  - Minori ingombri e costi rispetto alle parallele standard.
  - Usiamo parallele magnetiche con piastre ganasce avvitate
- Naturalmente tutti i componenti sono in acciaio speciale per molle e rettificati con tolleranze centesimali.

### ADVANTAGES:

- Quick and accurate positioning.
  - Saving with respect to the substitution of the whole jaw.
  - Space and money saving with respect to the standard parallel plates.
  - Use magnetic plates with jaw plates completely tightened
- Of course each component is made of hardened and ground spring steel and the accuracy is within 0,02 mm.

## ESEMPI DI APPLICAZIONE - TYPICAL ARRANGEMENTS

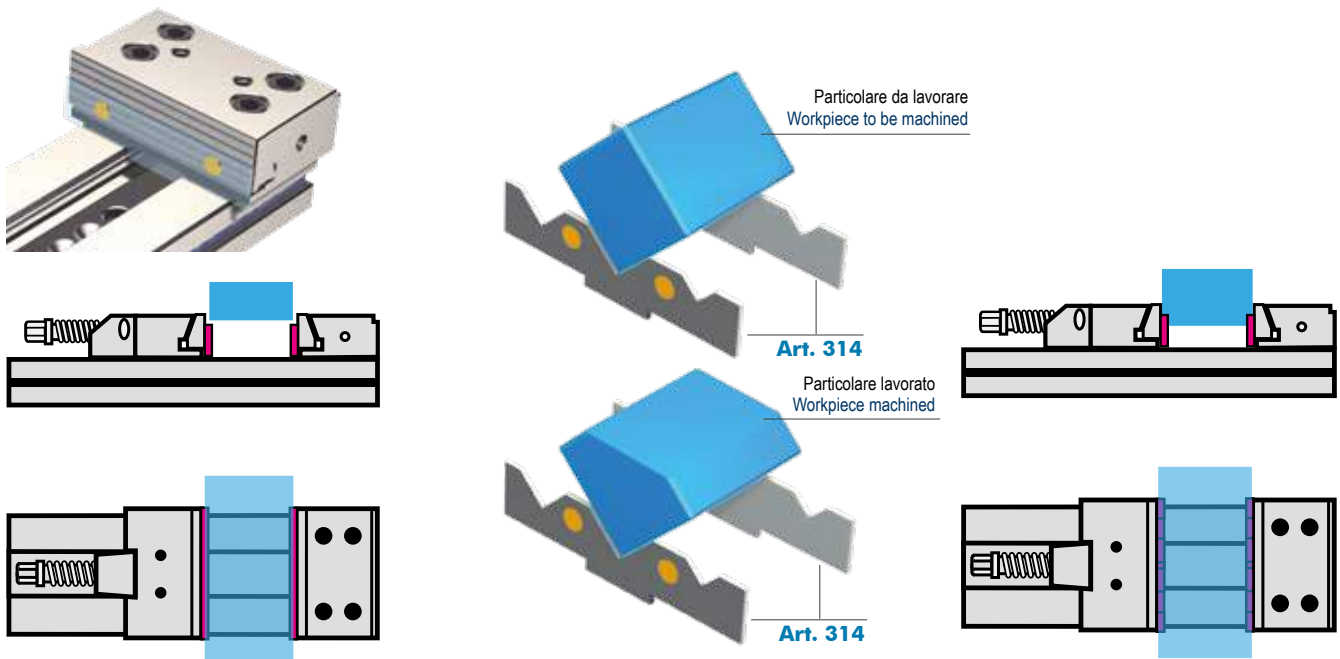

### Art. 317

Rastrelliera per piastre parallele magnetiche piane e angolari  
Rack for straight and angular parallel magnetic plates

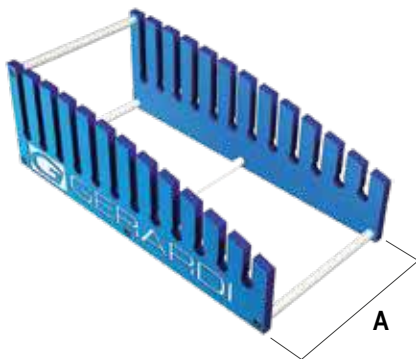

Per morse tipo (grandezza) da 1 a 6  
For vises (type) size 1 ÷ 6

A	60	70	80	100	120	150
Cod.	4.31.71000	4.31.72000	4.31.73000	4.31.74000	4.31.75000	4.31.76000

**Risparmio del 33 % sulla rastrelliera Art. 317 (Vuota) se acquistata insieme al set piccolo o grande di parallele magnetiche piane o angolari!**

**Save 33 % purchasing the rack Art. 317 Together with the small or big set of straight magnetic parallels plates !**

### Art. 313A

Magnete per parallele  
Magnet for parallels



Cod. 4.31.3A100

### NON MODULARI - NOT MODULAR

Richiedono aggiustaggio in opera - Adjustment needed before working

Per qualsiasi parallela speciale, raddoppiare il prezzo / For special tailor made parallel double the price

Tipo (grandezza) / Vise type (size)	1	2	3	4	5	6
<b>Art. 313</b>						
Coppia di parallele magnetiche guidate Pair of guided parallels magnetic plates						
H STANDARD FOR INSERT GRIP H STANDARD	-	-	-	20	20	30
	-	-	15	25	25	35
	-	15	20	30	30	40
	-	20	25	35	35	45
	15	25	30	40	40	50
	18	28	35	45	45	54
	20	30	40	50	50	60
	23	33	43	53	53	68
	<b>25</b>	<b>35</b>	<b>45</b>	<b>55</b>	57	70
	27	37	47	57	<b>60</b>	<b>75</b>
	B	30	40	50	60	65
W	100	125	150	175	200	300
Cod.	4.31.3100C	4.31.3200C	4.31.3300C	4.31.3400C	4.31.3500C	4.31.3600C

Tipo (grandezza) / Vise type (size)	1	2	3	4	5	6
<b>Art. 313R</b>						
Coppia di parallele magnetiche guidate ridotte Pair of narrow guided parallels magnetic plates						
<b>SPECIFICARE SEMPRE QUOTA "H" - ALWAYS SPECIFY "H" DIMENSION</b>						
W1	74	94	124	144	169	194
Cod.	4.31.3R10C	4.31.3R20C	4.31.3R30C	4.31.3R40C	4.31.3R50C	4.31.3R60C

**SET RISPARMIO FINO AL 47% - SAVING WITH THE SET UP TO 47%**

<b>6</b> COPPIE - PAIRS	Acquistando 6 coppie di parallele magnetiche (Art.313-313R) If you purchase 6 pairs of parallels magnetic plates (Art.313-313R)						
	Prezzo Cad. se acquistate con set Price each in case of set purchase						
<b>10</b> COPPIE - PAIRS	Acquistando 10 coppie di parallele magnetiche (Art.313-313R) If you purchase 10 pairs of parallels magnetic plates (Art.313-313R)						
	Prezzo Cad. se acquistate con set Price each in case of set purchase						

Tipo (grandezza) / Vise type (size)	1	2	3	4	5	6
<b>Art. 314</b>						
Coppia di parallele magnetiche angolari Pair of angular magnetic parallels plates						
alpha						
<b>SPECIFICARE SEMPRE QUOTA "alpha" - SPECIFY ALWAYS "alpha" DIMENSION</b>						
W	100	125	150	175	200	300
H	<b>23</b>	<b>33</b>	<b>43</b>	<b>53</b>	<b>53</b>	<b>68</b>
Cod.	4.31.4100C	4.31.4200C	4.31.4300C	4.31.4400C	4.31.4500C	4.31.4600C

**SET RISPARMIO FINO AL 43% - SAVING WITH THE SET UP TO 43%**











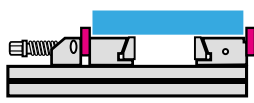

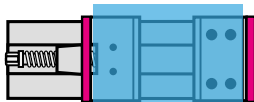
<b>6</b> COPPIE - PAIRS	Acquistando 6 coppie di parallele magnetiche angolari (Art.314) If you purchase 6 pairs of angular magnetic parallels plates (Art.314)						
	Prezzo Cad. se acquistate con set Price each in case of set purchase						

**Utilizzabili per qualsiasi tipo o marca di morsa - To be used with any vise type or brand**

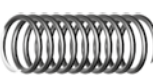
Tipo (grandezza) / Vise type (size)	1	2	3	4	5	6
<b>Art. 414</b>						
Coppia di parallele magnetiche universali Pair of universal parallels magnetic plates						
<b>SPECIFICARE SEMPRE QUOTA "H" - ALWAYS SPECIFY "H" DIMENSION</b>						
W	100	125	150	175	200	300
J	2,7	2,7	2,7	2,7	2,7	2,7
Cod.	4.41.4100C	4.41.4200C	4.41.4300C	4.41.4400C	4.41.4500C	4.41.4600C

Tipo (grandezza) / Vise type (size)	1	2	3	4	5	6
<b>Art. 414R</b>						
Coppia di parallele magnetiche ridotte universali Pair of universal narrow narrow parallels magnetic plates						
<b>SPECIFICARE SEMPRE QUOTA "H" - ALWAYS SPECIFY "H" DIMENSION</b>						
W1	74	94	124	144	169	194
Cod.	4.41.4R10C	4.41.4R20C	4.41.4R30C	4.41.4R40C	4.41.4R50C	4.41.4R60C

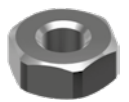
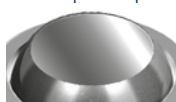
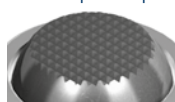
## ACCESSORI PER GANASCE / ACCESSORIES FOR JAWS

Tipo (grandezza) / Vise type (size)		1	2	3	4	5	6			
<b>Art. 132</b>	Prolunga per ganascia mobile. Larghezza normale Extension for movable jaw. Normal width	<b>NO StandardFLEX</b>		Cod.	2.13.21000	2.13.22000	2.13.23000	2.13.24000	2.13.25000	2.13.26000
										
<b>Art. 134</b>	Prolunga per ganascia mobile. Super ridotta Extension for movable jaw. Super narrow			Cod.	2.13.41000	2.13.42000	2.13.43000	2.13.44000	2.13.45000	2.13.46000
										
<b>Art. 133</b>	Prolunga per ganascia fissa. Larghezza normale Extension for fixed jaw. Normal width			Cod.	2.13.31000	2.13.32000	2.13.33000	2.13.34000	2.13.35000	2.13.36000
										
<b>Art. 135</b>	Prolunga per ganascia fissa. Ridotta e super ridotta Extension for fixed jaw. Narrow and super narrow		<b>NO StandardFLEX</b>	Cod.	2.13.51000	2.13.52000	2.13.53000	2.13.54000	2.13.55000	2.13.56000
										
<b>Art. 260</b>	Segmento oscillante per ganasce mobili. <b>Art. 190 - 191</b> Floating segment for movable jaws. <b>Art. 190 - 191</b>			Cod.	1.26.01000	1.26.02000	1.26.03000	1.26.04000	1.26.05000	1.26.06000
<b>Art. 362</b>	Molla per piastre ganasce Spring for jaw plates			Cod.	0.70.10000	0.70.20000	0.70.30000	0.70.40000	0.70.50000	0.70.60000
<b>Art. 380</b>	Vite TCEI fissaggio corpo ganascia fissa Hex socket and screw for fixed jaw body			Cod.	0.01.11030	0.01.10865	0.01.11450	0.01.11660	0.01.12065	0.01.12080
<b>Art. 381</b>	Vite TCEI fissaggio piastra ganascia fissa Hex socket screw for fixed plate			Cod.	0.01.10565	0.01.11240	0.01.11451	0.01.11661	0.01.12066	0.01.12081
										
<b>Art. 382</b>	Vite TCEI fissaggio piastra ganascia mobile Hex socket and screw for movable jaw plate			Cod.	0.01.10525	0.01.10830	0.01.10840	0.01.10845	0.01.11050	0.01.11065
										
<b>Art. 383</b>	Vite TCEI fissaggio piastra ganascia fissa doppia Hex socket and screw for double fixed jaw			Cod.	0.01.10520	0.01.10620	0.01.10820	0.01.11820	0.01.11020	0.01.11020
										
<b>Art. 384</b>	Vite TCEI per arresto laterale Hex socket and screw for workstop			Cod.	0.06.11100	0.06.22200	0.06.33300	0.06.44400	0.06.55500	0.06.66600
<b>Art. 431</b>	Rondella per arresto laterale Washer for workstop			Cod.	2.43.11000	2.43.12000	2.43.13000	2.43.14000	2.43.15000	2.43.16000
<b>Art. 440</b>	Dado per arresto laterale Nut for workstop			Cod.	2.44.01000	2.44.02000	2.44.03000	2.44.04000	2.44.05000	2.44.06000
<b>Art. 570</b>	Puntale sferico liscio Smooth spherical point			Cod.	1.57.01000	1.57.02000	1.57.03000	1.57.04000	1.57.05000	1.57.06000
<b>Art. 570S</b>	Puntale sferico zigrinato Serrated spherical point			Cod.	1.57.0S100	1.57.0S200	1.57.0S300	1.57.0S400	1.57.0S500	1.57.0S600
										

# CORPI GANASCE STANDARD / BODIES STANDARD JAWS

Tipo (grandezza) / Vise type (size)	1	2	3	4	5	6
<b>Art. 300</b> Corpo ganascia fissa. <b>Larghezza normale</b> Body fixed jaw. <b>Normal width</b>						
Cod.	1.35.10000	1.35.20000	1.35.30000	1.35.40000	1.35.50000	1.35.60000
<b>Art. 301</b> Corpo ganascia fissa. <b>Larghezza ridotta rettificata</b> Body fixed jaw. <b>Normal width ground</b>						
Cod.	1.35.10300	1.35.20300	1.35.30300	1.35.40300	1.35.50300	1.35.60300
<b>Art. 303</b> Corpo ganascia fissa doppia. <b>Larghezza normale</b> Double body fixed jaw. <b>Normal width</b>						
Cod.	1.35.10900	1.35.20900	1.35.30900	1.35.40900	1.35.50900	1.35.60900
<b>Art. 304</b> Corpo ganascia fissa doppia. <b>Larghezza ridotta rettificata</b> Double body fixed jaw. <b>Normal width ground</b>						
Cod.	1.35.11200	1.35.21200	1.35.31200	1.35.41200	1.35.51200	1.35.61200
<b>Art. 306</b> Corpo ganascia mobile guidata. <b>Larghezza normale</b> Body guided movable jaw. <b>Normal width</b>						
Cod.	1.36.10000	1.36.20000	1.36.30000	1.36.40000	1.36.50000	1.36.60000
<b>Art. 302</b> Corpo ganascia mobile oscillante. <b>Larghezza normale</b> Body floating movable jaws. <b>Normal width</b>						
Cod.	4.30.21000	4.30.22000	4.30.23000	4.30.24000	4.30.25000	4.30.26000
<b>Art. 307</b> Corpo ganascia mobile guidata. <b>Larghezza ridotta rettificata</b> Body guided movable jaw. <b>Narrow width ground</b>						
Cod.	1.36.11000	1.36.21000	1.36.31000	1.36.41000	1.36.51000	1.36.61000
<b>Art. 305</b> Corpo ganascia mobile guidata per segmenti oscillanti. <b>Larghezza normale</b> Body guided movable jaw for floating elements. <b>Normal width</b>						
Cod.	4.30.51000	4.30.52000	4.30.53000	4.30.54000	4.30.55000	4.30.56000
<b>Art. 308</b> Corpo ganascia mobile oscillante per segmenti oscillanti. <b>Larghezza normale</b> Body floating movable jaw for floating elements. <b>Normal width</b>						
Cod.	1.36.10400	1.36.20400	1.36.30400	1.36.40400	1.36.50400	1.36.60400
<b>Art. 309</b> Corpo ganascia mobile oscillante per segmenti oscillanti. <b>Larghezza ridotta</b> Body floating movable jaw for floating elements. <b>Narrow width</b>						
Cod.	1.36.10700	1.36.20700	1.36.30700	1.36.40700	1.36.50700	1.36.60700
<b>Art. 190</b> Corpo ganascia mobile oscillante guidata con 2 segmenti oscillanti. <b>Larghezza normale</b> Body guided floating movable jaw with 2 floating segments. <b>Normal width</b>						
Cod.	2.19.01000	2.19.02000	2.19.03000	2.19.04000	2.19.05000	2.19.06000
<b>Art. 191</b> Corpo ganascia mobile oscillante guidata con 2 segmenti oscillanti. <b>Larghezza ridotta</b> Body guided floating movable jaw with 2 floating segments. <b>Narrow width</b>						
Cod.	2.19.11000	2.19.12000	2.19.13000	2.19.14000	2.19.15000	2.19.16000

## CORPI GANASCE PIANE / BODY - STRAIGHT JAWS

**Tipo (grandezza) / Vise type (size)**
**1 2 3 4 5 6**
**Art. 315**

 Corpo ganascia fissa. **Larghezza normale**  
 Body fixed jaw. **Normal width**

Cod. 1.35.11800 1.35.21800 1.35.31800 1.35.41800 1.35.51800 1.35.61800

**Art. 316**

 Corpo ganascia fissa. **Larghezza ridotta rettificata**  
 Body fixed jaw. **Narrow width ground**

Cod. 1.35.12100 1.35.22100 1.35.32100 1.35.42100 1.35.52100 1.35.62100

**Art. 318**

 Corpo ganascia fissa doppia. **Larghezza normale**  
 Double body fixed jaw. **Normal width**

Cod. 1.35.12700 1.35.22700 1.35.32700 1.35.42700 1.35.52700 1.35.62700

**Art. 319**

 Corpo ganascia fissa doppia. **Larghezza ridotta rettificata**  
 Double body fixed jaw. **Narrow width ground**

Cod. 1.35.13000 1.35.23000 1.35.33000 1.35.43000 1.35.53000 1.35.63000

**Art. 321**

 Corpo ganascia mobile guidata. **Larghezza normale**  
 Body guided movable jaw. **Normal width**

Cod. 1.36.11600 1.36.21600 1.36.31600 1.36.41600 1.36.51600 1.36.61600

**Art. 322**

 Corpo ganascia mobile guidata. **Larghezza ridotta rettificata**  
 Body guided movable jaw. **Narrow width ground**

Cod. 1.36.12200 1.36.22200 1.36.32200 1.36.42200 1.36.52200 1.36.62200

**Art. 323**

 Corpo ganascia mobile oscillante. **Larghezza normale**  
 Body floating movable jaw. **Normal width**

Cod. 1.36.11300 1.36.21300 1.36.31300 1.36.41300 1.36.51300 1.36.61300

**Art. 324**

 Corpo ganascia mobile oscillante. **Larghezza ridotta rettificata**  
 Body floating movable jaw. **Narrow width ground**

Cod. 1.36.11900 1.36.21900 1.36.31900 1.36.41900 1.36.51900 1.36.61900

## CORPI GANASCE PER PIASTRE INTERCAMBIABILI MANUALMENTE JAW BODIES FOR QUICK INTRCHANGEABLE JAW PLATES

**Art. 300A**

 Corpo ganascia fissa  
 Fixed jaw body

Cod. 1.30.0A100 1.30.0A200 1.30.0A300 1.30.0A400 1.30.0A500 1.30.0A600

**Art. 303A**

 Corpo ganascia fissa doppia  
 Double fixed jaw body



Cod. 1.30.3A100 1.30.3A200 1.30.3A300 1.30.3A400 1.30.3A500 1.30.3A600

**Art. 306A**

 Corpo ganascia mobile guidata  
 Guided movable jaw body

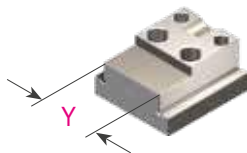

Cod. 1.30.6A100 1.30.6A200 1.30.6A300 1.30.6A400 1.30.6A500 1.30.6A600

**Art. 306B**

 Pattino per ganasce mobili guidate  
 Sliding plate for guided movable jaw

Cod. 1.30.6B100 1.30.6B200 1.30.6B300 1.30.6B400 1.30.6B500 1.30.6B600

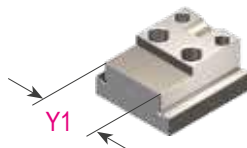
**Art. 306C**

 Pattino per ganasce mobili oscillanti  
 Sliding plate for floating movable jaw

Cod. 1.30.6C100 1.30.6C200 1.30.6C300 1.30.6C400 1.30.6C500 1.30.6C600

**Y1 = Y - 1mm**

# GRUPPI PREASSEMBLATI / PRE-ASSEMBLED GROUP

Tipo (grandezza) / Vise type (size)	1	2	3	4	5	6	
<b>Art. 105</b> Base girevole Swivel base	Ø B	180	225	290	320	370	400
	C	50	52	65	80	94	116
	D	112	146	175	200	220	240
	E	155	195	245	272	310	340
	F	20	23	28	28	34	38
	G	11	14	20	20	25	25
	H	6,5	8,5	12,5	12,5	17	17
	L	7	10	13	13	17	17
	M	12	14	20	20	26	26
	N	10	13	16	16	20	20
	O	6,5	8,5	12,5	12,5	16,5	16,5
	kg	3,3	5,5	10,8	13	21	25,3
	Cod.	2.10.51000	2.10.52000	2.10.53000	2.10.54000	2.10.55000	2.10.56000

Art. 105 - Senza alcuna dotazione  
 Art. 105 - Supplied without accessory equipment

<b>Art. 365</b> Anello esterno per base girevole Outer ring swivel base	Cod.	1.81.11000	1.81.21000	1.81.31000	1.81.41000	1.81.51000	1.81.61000
<b>Art. 366</b> Anello interno per base girevole Inner ring swivel base	Cod.	1.81.12000	1.81.22000	1.81.32000	1.81.42000	1.81.52000	1.81.62000
<b>Art. 367</b> Staffa per base girevole Clamp swivel base	Cod.	1.84.10000	1.84.20000	1.84.30000	1.84.40000	1.84.50000	1.84.60000
<b>Art. 368</b> Spina cilindrica per base girevole Straight pin swivel base	Cod.	0.80.11000	0.80.21000	0.80.31000	0.80.41000	0.80.51000	0.80.61000
<b>Art. 420</b> Vite esagonale per base girevole Bolt swivel base	Cod.	0.05.08035	0.05.10035	0.05.10040	0.05.12050	0.05.14060	0.05.14060
<b>Art. 430</b> Rondella per base girevole Washer swivel base	Cod.	0.75.18416	0.75.11052	0.75.11052	0.75.11325	0.75.11525	0.75.11525

**Art. 105** Base girevole / Swivel base  
 (Art. 365 + 366 + 367 + 368 + 420 + 430)

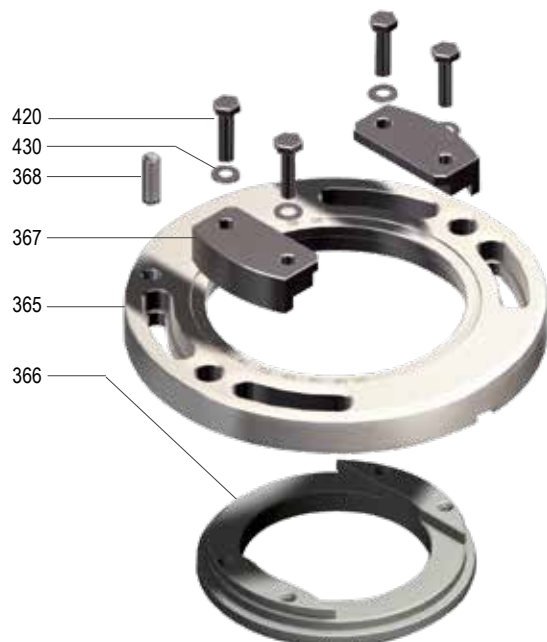
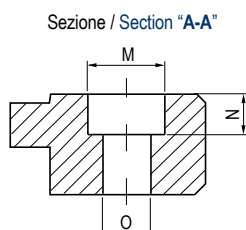
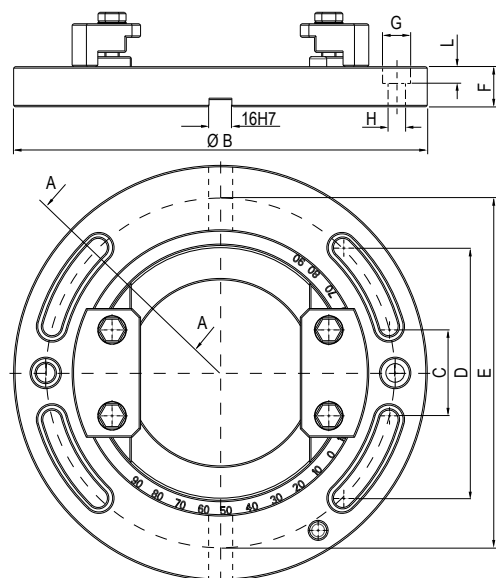

## GRUPPI PREASSEMBLATI / PRE-ASSEMBLED GROUP



**Art. 105**  
*Art. 105*

**Base girevole**  
Swivel base



**Art. 2**  
*Art. 2*

**Morsa STD Art. 1 + Base girevole Art.105**  
Art. 1 STD vise + Swivel base Art.105



**Art. 2**  
*Art. 2*

**Morsa STD Art. 1 + Base girevole Art.105**  
Art. 1 STD vise + Swivel base Art.105



**Morsa XL Art. 30A + Base girevole Art.105**  
Art. 30A XL vise + Swivel base Art.105



**Morsa STD Art. 15 + Base girevole Art.105**  
Art. 15 STD vise + Swivel base Art.105



**Art. 2A**  
*Art. 2A*

**Morsa STD Art. 1A + Base girevole Art.105**  
Art. 1A STD vise + Swivel base Art.105



# STAFFE DI ANCORAGGIO PER MORSE / VISE HOLDING CLAMPING

**Art. 296**

Coppia di staffe Art. 298 complete di vite e dado a T (Art. 287) / Pair of vise holding clamps Art. 298 complete of screws and T nuts (Art. 287)

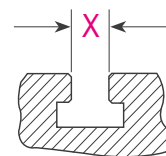
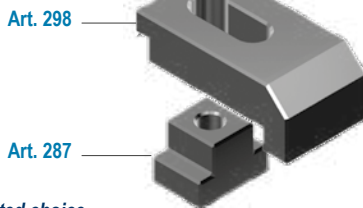
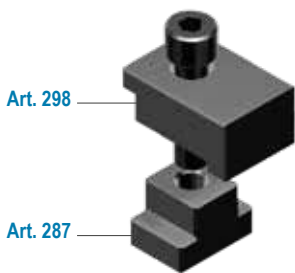

Specificare sempre la cava della vostra macchina

Always specify the machine T-slot dimension

\* Scelta consigliata - Suggested choice

Morse / Vises	Tipo (grandezza) morse / Vise (type) size							
STD	1	1 - 2		3 - 4		5 - 6		
FMS	1	1		2 - 3		4 - 5 - 6		
MULTIFLEX	1	1		2 - 3		-		
MULTITASKING	-	3		-		-		
COMPACT GRIP	-	1 - 2 - 3		-		-		
GRIPMATIC	-	2 - 3 - 4		-		-		
Staffe / Holding Clamps	<b>M8</b>	<b>M10</b>	<b>M12 *</b>	<b>M16</b>	<b>M12 *</b>	<b>M16</b>	<b>M12</b>	<b>M16 *</b>
Cod.	2.29.61000 / M8	2.29.61000 / M10	2.29.61000 / M12	2.29.61000 / M16	2.29.63000 / M12	2.29.63000 / M16	2.29.65000 / M12	2.29.65000 / M16

**Art. 298**

Staffe di ancoraggio per morse (Venduta singolarmente) / Vise holding clamps (Single)

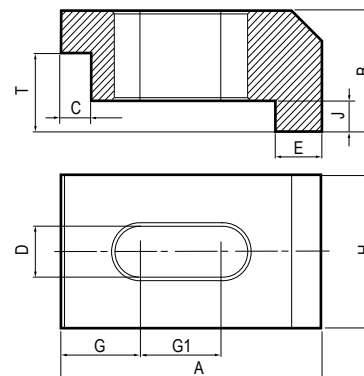
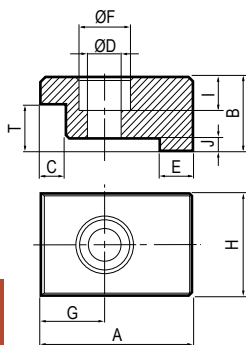
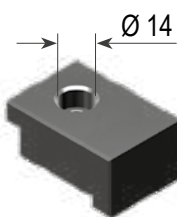
 Solo per tipo 1 x M8  
 Only for type 1 x M8

\* Scelta consigliata - Suggested choice

Morse / Vises	Tipo (grandezza) morse / Vise (type) size							
STD	1	1 - 2		3 - 4		5 - 6		
FMS	1	1		2 - 3		4 - 5 - 6		
MULTIFLEX	1	1		2 - 3		-		
MULTITASKING	-	3		-		-		
COMPACT GRIP	-	1 - 2 - 3		-		-		
GRIPMATIC	-	2 - 3 - 4		-		-		
Staffe / Holding Clamps	<b>M8</b>	<b>M10</b>	<b>M12 *</b>	<b>M16</b>	<b>M12 *</b>	<b>M16</b>	<b>M12</b>	<b>M16 *</b>
A	50	50	50	50	76	76	86	86
B	24	24	24	24	30	30	40	40
C	6	6	6	6	6	6	10	10
ØD	<b>8,5</b>	<b>11</b>	<b>13</b>	<b>17</b>	<b>13</b>	<b>17</b>	<b>13</b>	<b>17</b>
E	10	10	10	10	13	13	15	15
ØF	<b>14</b>	-	-	-	-	-	-	-
G / G1	<b>17</b>	<b>16 / 15</b>	<b>17,5 / 13</b>	<b>19 / 9</b>	<b>17 / 22</b>	<b>16 / 15</b>	<b>26 / 27</b>	<b>26 / 27</b>
H	34	34	34	34	42	42	50	50
I	8	10	10	10	-	-	-	-
J	4	4	4	4	10	10	10	10
T ±0,1	15	15	15	15	20	20	26	26
Cod.	2.29.81000 / M8	2.29.81000 / M10	2.29.81000 / M12	2.29.81000 / M16	2.29.83000 / M12	2.29.83000 / M16	2.29.85000 / M12	2.29.85000 / M16

## Art. 287

 Dadi per cave a T  
 Nuts for T slots

DIN 508

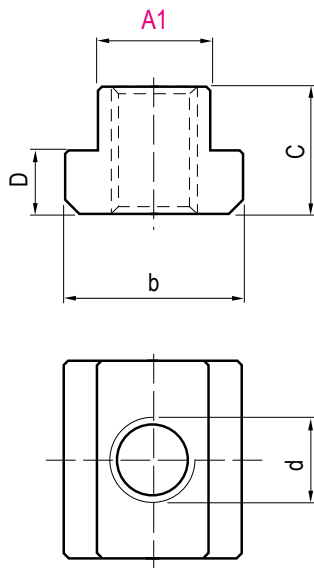
 In fase d'ordine,  
 completare il codice  
 specificando il  
 numero **N** di dado a T

 In the purchase order  
 specify the **N** number  
 of the **T** nut in the code

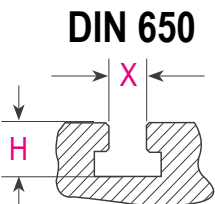
**Esempio / Example**  
 Cod. 2.28.74000 / 24

**DIN 650**  
 Specificare sempre la cava  
 della vostra macchina  
 Always specify  
 the machine T-slot dimension

N	d	A1	b	C	D	N	d	A1	b	C	D
01	M5 x 6	5,7	40	8	4	31	M14 x 24	23,7	40	32	16
02	M5 x 8	7,7	13	10	5	32	M16 x 18	17,7	28	20	10
03	M5 x 10	9,7	15	12	6	33	M16 x 20	19,7	32	24	12
04	M6 x 8	7,7	13	10	5	34	M16 x 22	21,7	35	28	14
05	M6 x 10	9,7	15	12	6	35	M16 x 24	23,7	40	32	16
06	M6 x 12	11,7	18	14	7	36	M16 x 28	27,7	44	36	18
07	M8 x 10	9,7	15	12	6	37	M16 x 30	29,7	48	38	19
08	M8 x 12	11,7	18	14	7	38	M16 x 36	35,6	54	44	22
09	M8 x 14	13,7	22	16	8	39	M18 x 20	19,7	32	24	12
10	M8 x 16	15,7	25	18	9	40	M18 x 22	21,7	35	28	14
11	M8 x 18	17,7	28	20	10	41	M18 x 24	23,7	40	32	16
12	M10 x 12	11,7	18	14	7	42	M18 x 28	27,7	44	36	18
13	M10 x 14	13,7	22	16	8	43	M18 x 30	29,7	48	38	19
14	M10 x 16	15,7	25	18	9	44	M18 x 36	35,6	54	44	22
15	M10 x 18	17,7	28	20	10	45	M20 x 22	21,7	35	28	14
16	M10 x 20	19,7	32	24	12	46	M20 x 24	23,7	40	32	16
17	M10 x 22	21,7	35	28	14	47	M20 x 28	27,7	44	36	18
18	M10 x 24	23,7	40	32	16	48	M20 x 30	29,7	48	38	19
19	M12 x 14	13,7	22	16	8	49	M20 x 36	35,6	54	44	22
20	M12 x 16	15,7	25	18	9	50	M20 x 42	41,6	65	52	26
21	M12 x 18	17,3	28	20	10	51	M20 x 48	47,6	75	60	30
22	M12 x 20	19,7	32	24	12	52	M24 x 28	27,7	44	36	18
23	M12 x 22	21,7	35	28	14	53	M24 x 30	29,7	48	38	19
24	M12 x 24	23,7	40	32	16	54	M24 x 36	35,6	54	44	22
25	M12 x 28	27,7	44	36	18	55	M24 x 42	41,6	65	52	26
26	M12 x 30	29,7	48	38	19	56	M24 x 48	47,6	75	60	30
27	M14 x 16	15,7	25	18	9	57	M30 x 36	35,6	54	44	22
28	M14 x 18	17,7	28	20	10	58	M30 x 42	41,6	65	52	26
29	M14 x 20	19,7	32	24	12	59	M30 x 48	47,6	75	60	30
30	M14 x 22	21,7	35	28	14	60	M30 x 54	53,6	85	70	35

 -Scelta **NON** consigliata - **NOT** Suggested choice

X	0 ÷ 22	23 ÷ 36	37 ÷ 54
Cod.	2.28.72000 / N	2.28.740000 / N	2.28.76000 / N

**Tipo (grandezza) morsa / Vise type (size)**
**1 2 3 4 5 6**

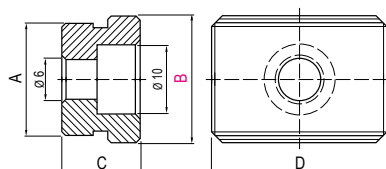

## Art. 297

 Coppia di tasselli di posizionamento completi di vite M5 x 10 / **Specificare sempre quota B**  
 Pair of positioning key-nuts with M5 x 10 clamping screw / **Specify always B dimension**



 Altri tipi e misure  
 fornibili a richiesta  
 Other types and dimensions  
 available on request

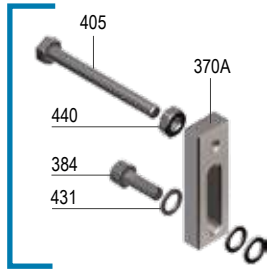

A	16									
B	10	12	14	16	18	20	22	24	28	36
C	10	10	10	10	10	12	12	12	12	12
D	25									
Cod.	2.29.71000									

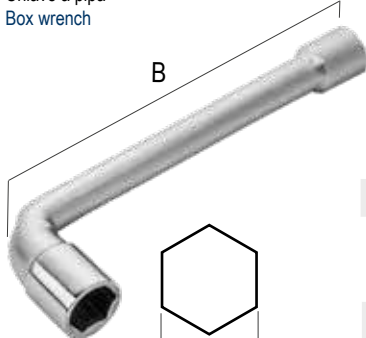
# ATTREZZI e DOTAZIONI / TOOLS and EQUIPMENT

Tipo (grandezza) morsa / Vise type (size)	1	2	3	4	5	6
<b>Art. 291</b> Tappo incavo per alloggiamento sfera <i>solo per Art.1A</i> Concave cap for sphere <i>only for Art.1A</i>						
Ø	13,2	20,8	20,8	25,8	25,8	25,8
Cod.	1.29.11000	1.29.12000	1.29.13000	1.29.14000	1.29.15000	1.29.16000
<b>Art. 325</b> Chiave esagonale a bussola Hexagon bushing						
CH	14	16	17	18	19	21
Cod.	0.09.32514	0.09.32516	0.09.32517	0.09.32518	0.09.32519	0.09.32521
CH	22	24	27	30	32	-
Cod.	0.09.32522	0.09.32524	0.09.32527	0.09.32530	0.09.32532	-
<b>Art. 370</b> Arresto laterale completo Complete workstop						
<b>Art. 405</b> Vite principale per arresto laterale (Ricambio) Main bolt for workstop (Spare)	405					
<b>Art. 370A</b> Staffa per arresto laterale (Ricambio) Klamps for workstop (Spare)	370A					
	440					
	384					
	431					
Cod.	2.37.01000		2.37.03000		2.37.05000	
Cod.	1.77.10120				1.77.16180	
Cod.	2.37.0A100		2.37.0A300		2.37.0A500	

Tipo (grandezza) morsa / Vise type (size)	1	2	3	4	5	6
<b>Art. 375</b> Chiave a pipa Box wrench						
<b>Dimensioni / Dimension</b>	CH	B	CH	B	CH	B
<b>Morse Standard / Standard Vises</b>	12	160	19	250	22	300
Cod.	4.37.512160	4.37.519250	4.37.522300	4.37.522300	4.37.530480	4.37.530480
<b>Morse FMS / FMS Vises</b>	16	250	16	250	19	250
Cod.	4.37.516250	4.37.516250	4.37.519250	4.37.519250	4.37.519250	4.37.519250
Vedi pag. 5.61 See pag. 5.61						
<b>Morse Multitasking / Multitasking Vises</b>	12	250	16	250	16	250
Cod.	4.37.512160	4.37.516250	4.37.516250	-	-	-
Vedi pag. 7.29 See pag. 7.29						
<b>Morse Compact Grip / Compact Grip Vises</b>	10	160	12	160	16	250
Cod.	4.37.510160	4.37.512160	4.37.516250	-	-	-
Vedi pag. 7.29 See pag. 7.29						

<b>Art. 376</b> Chiave a T T wrench						
CH	4	5	6	10		
Cod.	0.09.21400	0.09.22500	0.09.23600	0.09.25100		
<b>Art. 377</b> Chiave esagonale serie lunga Hexagon wrench long reach						
CH	2	2,5	3	3,5	4	4,5
Cod.	0.09.37702	0.09.37725	0.09.37703	0.09.37735	0.09.37704	0.09.37745
CH	5	6	7	8	9	10
Cod.	0.09.37705	0.09.37706	0.09.37707	0.09.37708	0.09.37709	0.09.37710
CH	12	13	14	17	19	-
Cod.	0.09.37712	0.09.37713	0.09.37714	0.09.37717	0.09.37719	-

Tipo (grandezza) morsa / Vise type (size)	1	2	3
<b>Art. 357</b> Chiave dinamometrica digitale a cricchetto con attacco 1/2" Torque wrench digital ratchet type with hexagon with 1/2" driver square			
Nm	10÷135	20÷200	34÷340
Cod.	2.35.71000	2.35.72000	2.35.73000

**DISPOSITIVI MECCANICI / MECHANICAL BLOCKING DEVICES**

Tipo (grandezza) morsa / Vise type (size)	1	2	3	4	5	6
<b>Art. 258</b> Gruppo di serraggio meccanico completo senza accessori Mechanical clamping device complete No accessories						
						
kg	0,4	1	1,9	2,9	5,3	7,8
Cod.	2.25.81000	2.25.82000	2.25.83000	2.25.84000	2.25.85000	2.25.86000

 Per le forze di serraggio vedi pag. 4.00  
 For clamping force see page 4.00

**RICAMBI / SPARE PARTS**
**Art. 360**

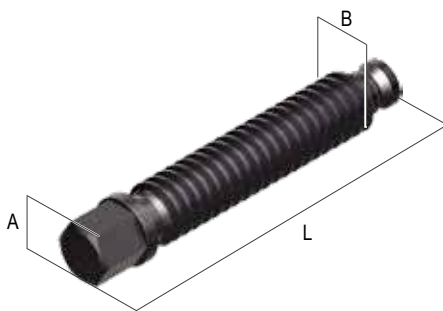
 Vite di spinta. Normale  
 Clamping bolt. Normal

A	12	19	22	30
B	M12	TPN 18 x 4	TPN 24 x 5	TPN 30 x 5
L	100	130	150	190
Cod.	1.90.10144	1.90.20184	1.90.30245	1.90.50366

**Art. 355**

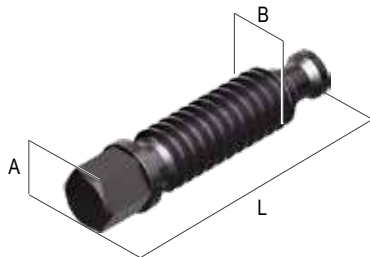
 Vite di spinta. Ridotta  
 Clamping bolt. Short

A	12	19	22	30
B	M12	TPN 18 x 4	TPN 24 x 5	TPN 30 x 5
L	90	100	115	150
Cod.	1.90.14144	1.90.24184	1.90.34245	1.90.54366

**Art. 356**

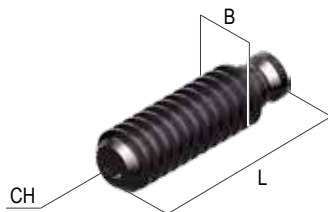
 Vite di spinta. Super ridotta  
 Clamping bolt. Super short

CH	6	8	10	12
B	M12	TPN 18 x 4	TPN 24 x 5	TPN 30 x 5
L	53	73	81	113
Cod.	1.35.61000	1.35.62000	1.35.60003	1.35.60005

**Art. 282A**

 Supporto di serraggio meccanico  
 Mechanical clamping device support

Cod.	2.28.2A100	2.28.2A200	2.28.2A300	2.28.2A400	2.28.2A500	2.28.2A600

**Art. 410**

 Grano  
 Setscrew









	0.06.20810	0.06.21012	0.06.21216	0.06.21620	0.06.21630	0.06.31360
Cod.	M8 x 20	M10 x 25	M12 x 30	M12 x 40	M20 x 50	M20 x 50
	CH. 3	CH. 5	CH. 6	CH. 6	CH. 10	CH. 10

**Art. 361**

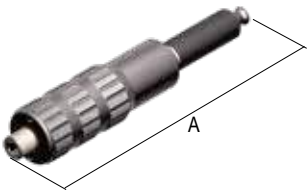
 Sfera  
 Ball

Cod.	1.36.11001	1.36.12002	1.36.13003	1.36.14004	1.36.15005	1.36.16006
	9/16"	3/4"	7/8"	7/8"	1 1/8"	1 1/8"

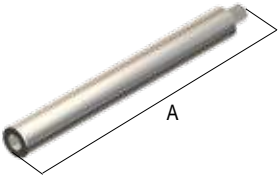
# SERVOCOMANDI OLEODINAMICI / HYDRAULIC SERVO UNITS

Tipo (grandezza) morsa / Vise type (size)	1	2	3	4	5	6
<b>Art. 257</b> Gruppo di serraggio a vite idraulica (Autonomo) Hydraulic hand screw clamping device (Self contained)						
Cod.	-	2.25.73000	2.25.74000	2.25.75000	2.25.76000	
<b>Art. 284A</b> Supporto di serraggio per mandrino a vite idraulica Clamping support for hydraulic spindle						
Cod.	-	2.28.4A300	2.28.4A400	2.28.4A500	2.28.4A600	
<b>Art. 286</b> Mandrino a vite idraulica Hydraulic spindle						
Kn	-	12	20			
A	-	420	359			
Cod.	-	4.28.63000	4.28.65000			
<b>Art. 295</b> Gruppo di serraggio a vite idraulica compatto Compact hydraulic hand screw clamping device						
Cod.	-	4.29.53000	4.29.54000	-	-	
<b>Art. 294</b> Supporto di serraggio per mandrino compatto a vite idraulica Clamping support for compact hydraulic spindle						
Cod.	-	4.29.43000	4.29.44000	-	-	
<b>Art. 293</b> Mandrino compatto a vite idraulica Compact hydraulic spindle						
Kn	-	10	-			
A	-	173				
Cod.	-	4.29.33000	4.29.34000	-	-	
<b>Art. 290</b> Manovella per mandrino a vite idraulica Crank hydraulic spindle						
Cod.	-		0.09.73000			
<b>Art. 292</b> Prolunga per Art. 290 Extension for Art. 290						
A		160 / 260				
Cod.	-	4.29.23000				

# METODI ALTERNATIVI DI SERRAGGIO

## ALTERNATIVE CLAMPING OPTION

Il gruppo di serraggio a vite idraulica, è un moltiplicatore di forza manuale alternativo al gruppo di serraggio meccanico **Art. 258**; Tale dispositivo consente di applicare la medesima forza di serraggio della vite manuale con uno sforzo minore. Il mandrino a vite idraulica è azionato manualmente tramite l'apposita manovella in dotazione **Art. 290**.

Verificare che il vano tra ganasce mobile **A** e supporto vite **B** sia pulito, in modo che il mandrino idraulico possa scorrere liberamente senza impedimenti che potrebbero causare attriti e di conseguenza minor forza di serraggio.

Ruotare in senso orario il mandrino utilizzando la manovella in dotazione **Art. 290**, muovendo la ganasce mobile **A** in avanti fino al contatto con il pezzo da serrare. Un' ulteriore rotazione farà scattare la frizione e di conseguenza da quel momento inizia la forza di spinta idraulica e mentre il mandrino rimane fermo, avanza la vite **1** che spinge lo stantuffo **2** nella camera d'olio **3** generando pressione. Dopo il prearico meccanico **ogni giro di manovella genera una forza K** e **quando il mandrino arriva in battuta, sviluppa la massima forza possibile**.

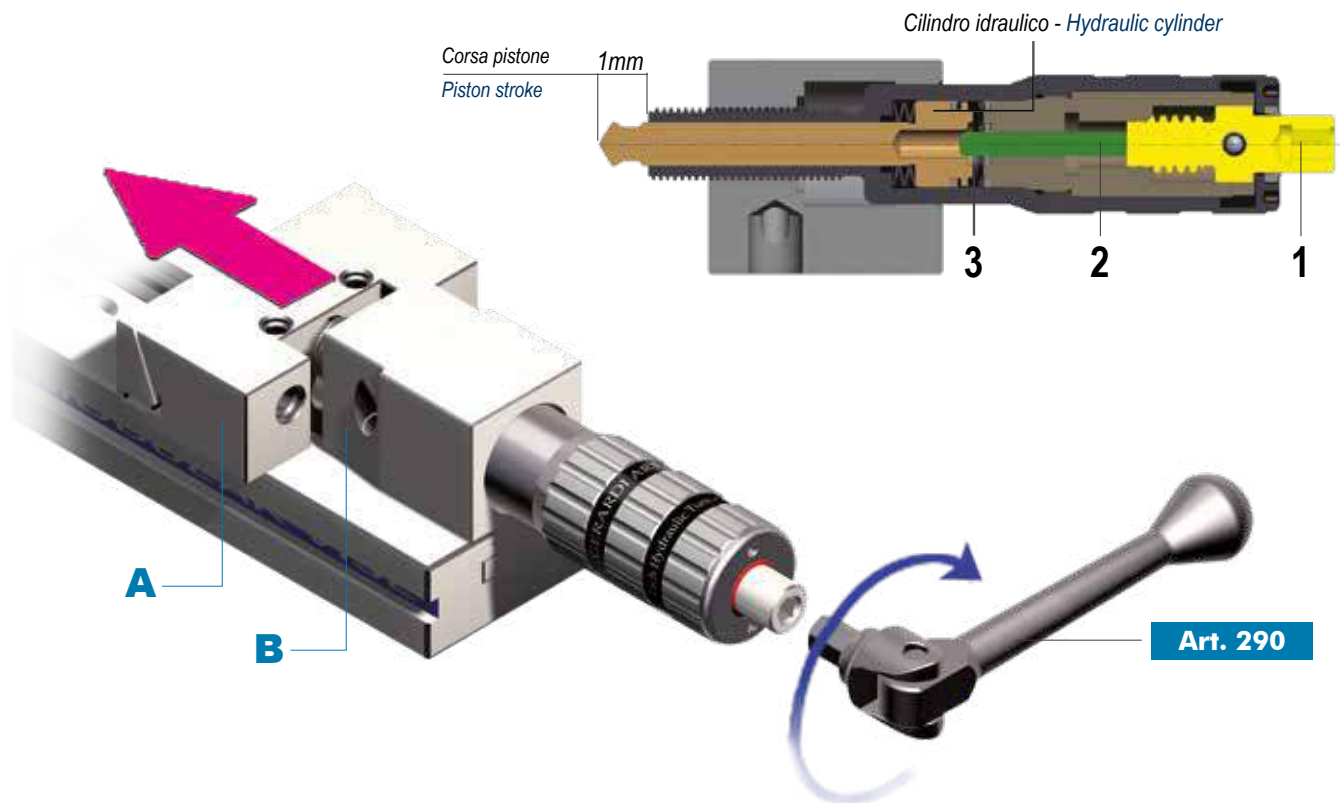

### ATTENZIONE !

Quando il mandrino arriva in battuta, una ulteriore pressione sviluppata sulla manovella (Art. 290) potrebbe danneggiare in modo irreparabile il moltiplicatore.

### ATTENTION !

When the spindle reach the end of his stroke, a further pressure on the wrench (Art. 290) can seriously damage the pressure multiplier

The hand hydraulic clamping group is a manual power multiplier alternative to the mechanical clamping group **Art.258**. This device allows to reach the same clamping power reachable with the mechanical screw through a minimum effort. The hand hydraulic screw is manually operated by the proper wrench **Art.290**. Make sure that space between the movable jaw **A** and the main spindle support **B** is clean so that the hydraulic spindle can move freely without chips inside causing frictions and consequently less clamping power.

Turn clockwise the spindle using the wrench **Art. 290** supplied in the standard equipment until the movable jaw **A** touches workpiece. A further rotation will start the power multiplier action; at every spindle turn an increasing clamping power will be applied to the workpiece. A further rotation will make the crank slip and the hydraulic power will start. The hydraulic spindle will stop turning but the screw **1** will move forward to push the small piston **2** into the oil chamber **3** creating an overpressure and obviously clamping force. After the mechanical pre-loading **each turn of the wrench produce a K force** and **when the spindle reaches the end of its possible run it reaches its max possible power**.

## Diagrammi di serraggio / Clamping diagrams

# Gruppi di serraggio idraulici Hydraulic clamping devices

### Diagrammi di serraggio meccanico con vite idraulica

#### Mechanical clamping diagrams with hydraulic hand screw

**Morse tipo**  
Vises type

**3-4**

Autonomo - Self Contained

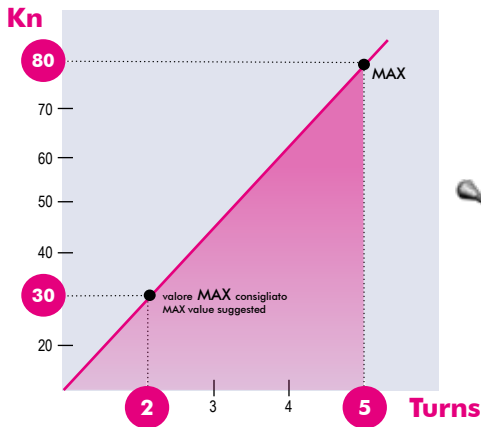

Art. 257

**Morse tipo**  
Vises type

**5-6**

Autonomo - Self Contained

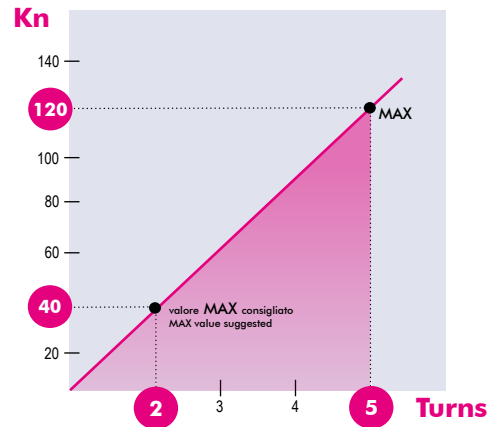

### Gruppi di serraggio meccanici (Art.257 - Art.295) / Mechanical clamping devices (Art.257 - Art.295)

I diagrammi seguenti consentono di determinare le forze di serraggio ottenibili con i seguenti gruppi di serraggio idraulici (da 1 a 6), in funzione dei giri applicati  
The following diagrams give the clamping force that can be obtained with each hydraulic clamping devices type (size 1 to 6) depending on the turns

**Morse tipo**  
Vises type

**3-4**

Compatto - Compact

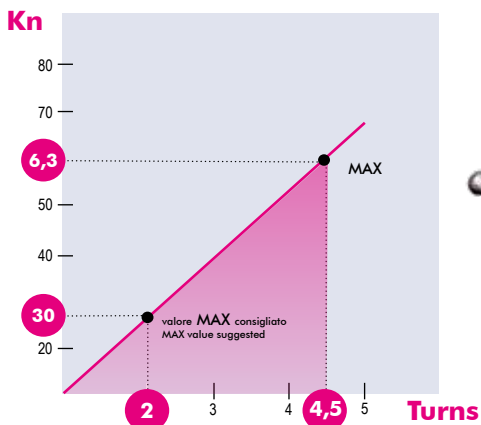

Art. 295

NB: Alcuni fattori, come la lubrificazione, lo staffaggio, gli attriti ed altro, possono modificare i valori indicati fino a  $\pm 10\%$ . Per un corretto utilizzo non superare i valori indicati nel grafico  
Some factor as lubrication, clamping on the machine table, frictions and more can modify above values within a  $\pm 10\%$  range. For optimum operation do not exceed chart values.

**MORSE StandardMatic**

Tipo (grandezza) morsa / Vise type (size)	kN	1		2		3		4	
		16 kN	25 kN	30 kN	30 kN	30 kN	30 kN	30 kN	30 kN
Apertura massima / Maximum spread	A	100	150	200	300	200	300	400	500
	W	100	125	150		175			
	B	30	40	50		60			
	C	35	40	50		58			
	D	270	345	420	520	455	555	655	755
	G	75	95	125		145			
	X								
	kg	6.8	12.9	25.5	29	37	42	47	52
	Cod.	1.1E.10000	1.1E.20000	1.1E.32000	1.1E.33000	1.1E.42000	1.1E.43000	1.1E.44000	1.1E.45000

**Art. 1E**

 Morsa modulare STD  
 con cilindro idraulico a  
 SINGOLO effetto

Art.271

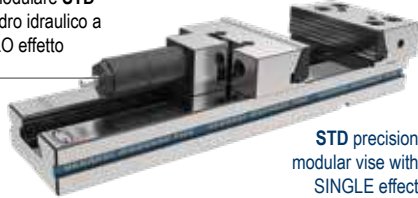
 STD precision  
 modular vise with  
 SINGLE effect  
 hydraulic cylinder

**NEW  
2021**
**Art. 393**

MAX 450bar

 Centralina a comando  
 manuale **singolo effetto**  
 Single effect power unit  
 with manual control

Cod. 4.39.34500

**Art. 394**

MAX 450bar

 Centralina a comando  
 pneumatico remoto **singolo effetto**  
 Single effect power unit  
 with remote pneumatic control

Per azionare la centralina è consigliato l'uso dell' ART.402 (vedi pag.4.52)

Cod. 4.39.44500

**Art. 395**

MAX 450bar

 Centralina a comando  
 elettrico **singolo effetto**  
 Single effect power unit  
 with electrical control

Cod. 4.39.54500

**Art. 407**

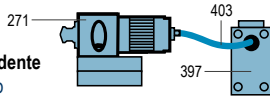
 Gruppo di serraggio **indipendente**  
 Independent clamping group

Le corse del pistone sono disponibili a pagina 4.54

Cod. 4.40.71000 4.40.72000 4.40.73000 4.40.74000

**MANUAL CONTROL**
**Art. 407A**

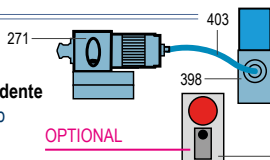
 Gruppo di serraggio **indipendente**  
 Independent clamping group

Le corse del pistone sono disponibili a pagina 4.54

Cod. 4.40.7A100 4.40.7A200 4.40.7A300 4.40.7A400

**CNC CONTROL**

Art. 401 Pulsantiera / Pushbutton board

**Art. 407B**

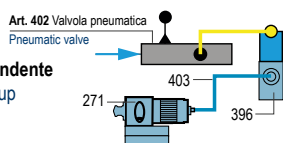
 Gruppo di serraggio **indipendente**  
 Independent clamping group

Cod. 4.40.7B100 4.40.7B200 4.40.7B300 4.40.7B400

**AIR CONTROL**

Dotazione standard:

- 1 arresto laterale Art. 370
- 1 coppia di tasselli di posizionamento Art. 297 (Standard per cava da 16 mm; altre dimensioni a richiesta senza variazione di prezzo)
- 1 chiave a "T" Art. 376

Extra per ogni foro calibrato (tolleranza F7): € 90,00 - Extra per ogni chiave (tolleranza H7): € 200,00

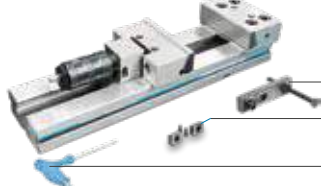

Art. 1E

Art. 370

Art. 297

Art. 376

Standard equipment:

- 1 workstop Art. 370
- 1 pair of positioning key-nuts Art. 297 (Standard for 16 mm slot. Other dimensions available on request without price change)
- 1 T-wrench Art. 376

Extra charge for each calibrated hole (F7 tolerance): € 90,00 - Extra charge for each calibrated key nut (F7 tolerance): € 200,00

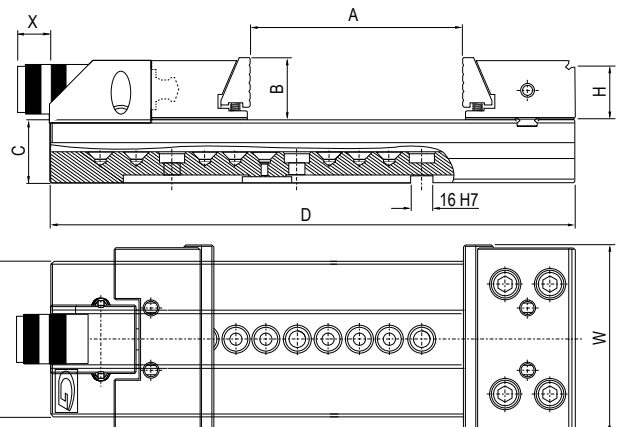
**ESEMPIO D'ORDINE PER KIT COMPLETO:** Art.1E (Morsa) + Art.393 (centralina a comando manuale) + Art.403 (tubo 1,5M)  
**COMPLETE KIT ORDER EXAMPLE:** Art.1E (Vise) + Art.393 (power unit with manual control) + Art.403 (pipe 1,5M)



**StandardMatic VISES**

5 40 kN						6 40 kN						
A	200	300	400	500	600	200	300	400	500	600	700	800
W			200						300			
B			65						80			
C			70						78			
D	495	595	695	795	895	535	635	735	835	935	1035	1135
G			170						195			
X												
kg	64	69	74	79	84	95	105	115	125	135	145	155
Cod.	1.1E.52000	1.1E.53000	1.1E.54000	1.1E.55000	1.1E.56000	1.1E.62000	1.1E.63000	1.1E.64000	1.1E.65000	1.1E.66000	1.1E.67000	1.1E.68000

4.39.34500

**Art. 393**

4.39.34500

**MANUAL CONTROL**

Suggest the ART.402 (see pag.4.52) to use power unit

4.39.44500

**Art. 394**

4.39.44500

**AIR CONTROL**

4.39.54500

**Art. 395**

4.39.54500

**CNC CONTROL**

Piston strokes are available at page 4.54

4.40.75000

**Art. 407**

4.40.76000

**MANUAL CONTROL**

Piston strokes are available at page 4.54

4.40.7A500

**Art. 407A**

4.40.7A600

**CNC CONTROL**

4.40.7B500

**Art. 407B**

4.40.7B600

 Pneumo-hydraulic servo units (complete of hydraulic cylinder + support) for multiple clamping **simultaneous** or **independent**, from 2 to 6 vises. See from page 4.38 to 4.49

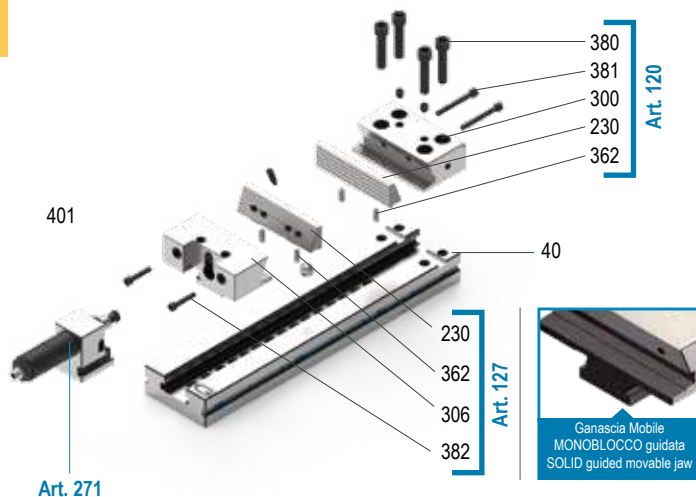
**Art. 1E**

Art.	Pag.
<b>40</b>	1.24
<b>230</b>	4.9
<b>271</b>	4.54
<b>300</b>	4.29
<b>306</b>	4.29
<b>362</b>	4.28
<b>380</b>	4.28
<b>381</b>	4.28
<b>382</b>	4.28

**MORSE StandardMatic**

Tipo (grandezza) morsa / Vise type (size)	kN	1		2		3		4	
		16 kN	25 kN	30 kN	30 kN	30 kN	30 kN	30 kN	
Apertura massima / Maximum spread	A	100	150	200	300	200	300	400	500
	W	100	125	150		175			
	B	30	40	50		60			
	C	35	40	50		58			
	D	270	345	420	520	455	555	655	755
	G	75	95	125		145			
	X								
	kg	6.8	12.9	25.5	29	37	42	47	52
	Cod.	1.1F.10000	1.1F.20000	1.1F.32000	1.1F.33000	1.1F.42000	1.1F.43000	1.1F.44000	1.1F.45000

**Art. 1F**

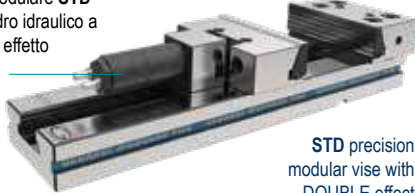
 Morsa modulare STD  
 con cilindro idraulico a  
 DOPPIO effetto  
 Art.271D

 STD precision  
 modular vise with  
 DOUBLE effect  
 hydraulic cylinder

**NEW  
2021**
**Art. 393D** MAX 450bar

 Centralina a comando  
 manuale **doppio effetto**  
 Double effect power unit  
 with manual control

Cod. 4.39.3D450

**Art. 394D** MAX 450bar

 Centralina a comando pneumatico  
 remoto **doppio effetto**  
 Double effect power unit with  
 remote pneumatic control

Per azionare la centralina è consigliato l'uso dell' ART.402 (vedi pag.4.52)

Cod. 4.39.4D450

**Art. 395D** MAX 450bar

 Centralina a comando  
 elettrico **doppio**  
 Power unit with **double**  
 electrical control

Cod. 4.39.5D450

**Art. 407C**

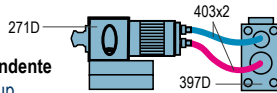
 Gruppo di serraggio **indipendente**  
 Independent clamping group

Le corse del pistone sono disponibili a pagina 4.54

Cod. 4.40.7C100 4.40.7C200 4.40.7C300 4.40.7C400

**MANUAL CONTROL**
**Art. 407D**

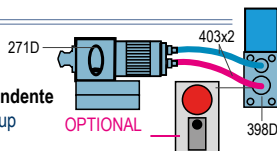
 Gruppo di serraggio **indipendente**  
 Independent clamping group

Le corse del pistone sono disponibili a pagina 4.54

Cod. 4.40.7D100 4.40.7D200 4.40.7D300 4.40.7D400

**CNC CONTROL**
**Art. 407E**

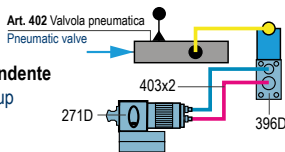
 Gruppo di serraggio **indipendente**  
 Independent clamping group

Cod. 4.40.7E100 4.40.7E200 4.40.7E300 4.40.7E400

**AIR CONTROL**

Dotazione standard:

- 1 arresto laterale Art. 370
- 1 coppia di tasselli di posizionamento Art. 297 (Standard per cava da 16 mm; altre dimensioni a richiesta senza variazione di prezzo)
- 1 chiave a "T" Art. 376

Extra per ogni foro calibrato (tolleranza F7): € 90,00 - Extra per ogni chiave (tolleranza H7): € 200,00

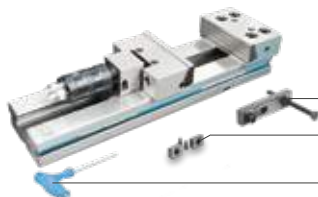

Art. 1E

Art. 370

Art. 297

Art. 376

Standard equipment:

- 1 workstop Art. 370
- 1 pair of positioning key-nuts Art. 297 (Standard for 16 mm slot. Other dimensions available on request without price change)
- 1 T-wrench Art. 376

Extra charge for each calibrated hole (F7 tolerance): € 90,00 - Extra charge for each calibrated key nut (F7 tolerance): € 200,00

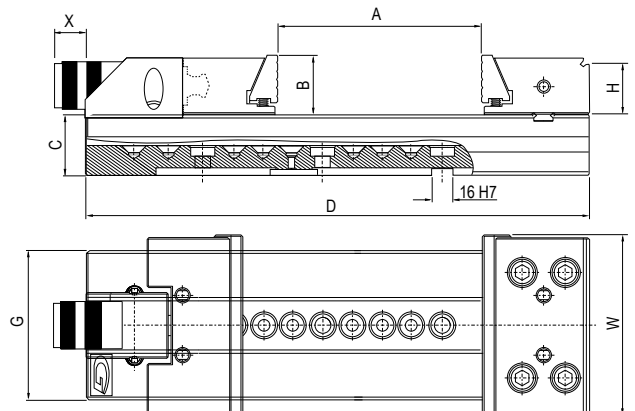
**ESEMPIO D'ORDINE PER KIT COMPLETO:** Art.1F (Morsa) + Art.393 (centralina a comando manuale) + Art.403 (tubo 1,5M)  
**COMPLETE KIT ORDER EXAMPLE:** Art.1F (Vise) + Art.393 (power unit with manual control) + Art.403 (pipe 1,5M)

**StandardMatic VISES**

5 40 kN						6 40 kN						
A	200	300	400	500	600	200	300	400	500	600	700	800
W			200						300			
B			65						80			
C			70						78			
D	495	595	695	795	895	535	635	735	835	935	1035	1135
G			170						195			
X												
kg	64	69	74	79	84	95	105	115	125	135	145	155
Cod.	1.1F.52000	1.1F.53000	1.1F.54000	1.1F.55000	1.1F.56000	1.1F.62000	1.1F.63000	1.1F.64000	1.1F.65000	1.1F.66000	1.1F.67000	1.1F.68000

Art. 393 4.39.3D450

4.39.3D450  
**MANUAL CONTROL**

Suggest the ART.402 (see pag.4.52) to use power unit

Art. 394 4.39.4D450

4.39.4D450  
**AIR CONTROL**

Art. 395 4.39.5D450

4.39.5D450  
**CNC CONTROL**

Piston strokes are available at page 4.54

Art. 407C 4.40.7C500 4.40.7C600

**MANUAL CONTROL**

Piston strokes are available at page 4.54

Art. 407D 4.40.7D500 4.40.7D600

**CNC CONTROL**

Art. 407E 4.40.7E500 4.40.7E600

 Pneumo-hydraulic servo units (complete of hydraulic cylinder + support) for multiple clamping *simultaneous* or *independent*, from 2 to 6 vises. See from page 4.38 to 4.49

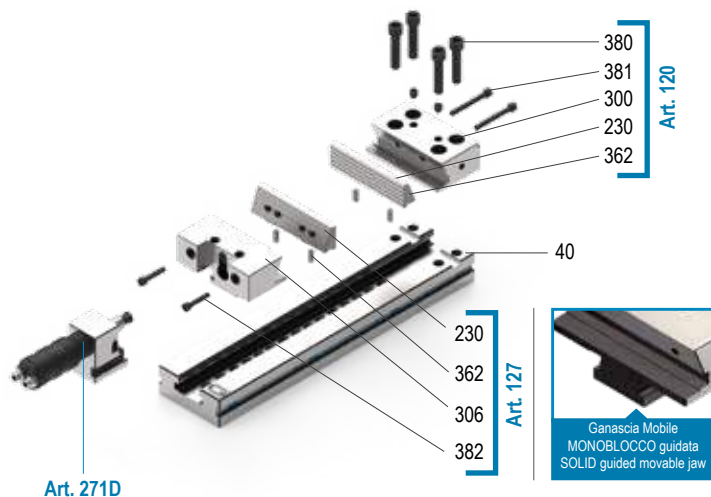
**Art. 1F**

Art.	Pag.
<b>40</b>	1.24
<b>230</b>	4.9
<b>271D</b>	4.54
<b>300</b>	4.29
<b>362</b>	4.28
<b>381</b>	4.28
<b>382</b>	4.28

**COMANDO MANUALE - MANUAL CONTROL**
**SINGOLO EFFETTO**
**SINGLE EFFECT**
**Tipo (grandezza) morsa / Vise type (size)**

<b>1</b>	<b>2</b>	<b>3</b>	<b>4</b>	<b>5</b>	<b>6</b>
----------	----------	----------	----------	----------	----------

**Art. 390**

 N° 1 serraggio  
 N° 1 clamping

**MORSA NON COMPRESA**  
**VICE NOT INCLUDED**

 403 tubo idraulico Multispiral  
 Hydraulic pipe Multispiral

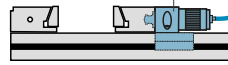
 271 cilindro idraulico  
 Hydraulic cylinder

 Ingresso aria  
 Air inlet

 393 centralina a comando manuale  
 Power unit with manual control

Cod.	4.39.01000	4.39.02000	4.39.03000	4.39.04000	4.39.05000	4.39.06000
------	------------	------------	------------	------------	------------	------------

**Art. 393 + Art. 271 + Art. 403 (m 1,5)**
**Art. 390/2**

 N° 2 serraggi contemporanei  
 N° 2 simultaneously clamping

**Art. 390 + n° 1 Art. 271**

+1 Art. 271

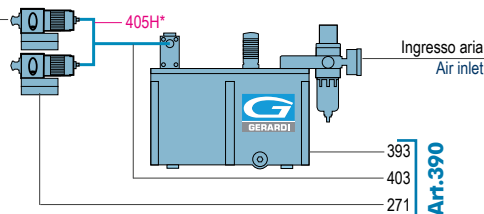
 Ingresso aria  
 Air inlet

Cod.	4.39.01002	4.39.02002	4.39.03002	4.39.04002	4.39.05002	4.39.06002
------	------------	------------	------------	------------	------------	------------

\* Non incluso (Pag. 4.52) / Not included (Pag. 4.52)

**Art. 390/3**

 N° 3 serraggi contemporanei  
 N° 3 simultaneously clamping

**Art. 390 + n° 2 Art. 271**

+2 Art. 271

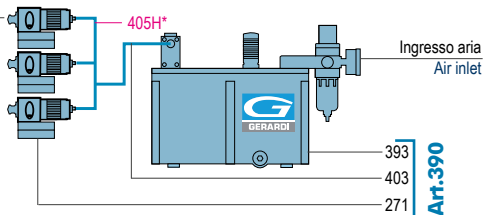
 Ingresso aria  
 Air inlet

Cod.	4.39.01003	4.39.02003	4.39.03003	4.39.04003	4.39.05003	4.39.06003
------	------------	------------	------------	------------	------------	------------

\* Non incluso (Pag. 4.52) / Not included (Pag. 4.52)

**Art. 390/4**

 N° 4 serraggi contemporanei  
 N° 4 simultaneously clamping

**Art. 390 + n° 3 Art. 271**

+3 Art. 271

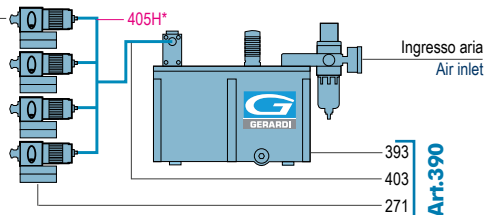

 Ingresso aria  
 Air inlet

Cod.	4.39.01004	4.39.02004	4.39.03004	4.39.04004	4.39.05004	4.39.06004
------	------------	------------	------------	------------	------------	------------

\* Non incluso (Pag. 4.52) / Not included (Pag. 4.52)

**Art. 407**

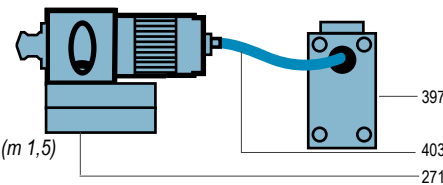
 Gruppo di serraggio indipendente  
 Independent clamping group

**Art. 271 + Art. 397 + Art. 403 (m 1,5)**

Cod.	4.40.71000	4.40.72000	4.40.73000	4.40.74000	4.40.75000	4.40.76000
------	------------	------------	------------	------------	------------	------------

**Possibilità di automatizzare tutte le morse STD / StandardFLEX / XL / Elementi modulari. (Esclusi Art.1E, Art.1F)**
**Art. 390A / 2**

 N° 2 serraggi indipendenti  
 N° 2 independent clamping

**Art. 390 + n° 1 Art. 407**

+1 Art. 407

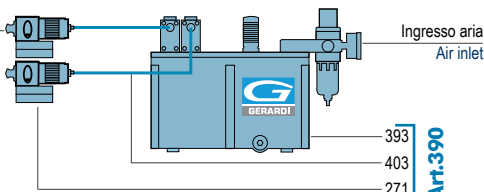
 Ingresso aria  
 Air inlet

Cod.	4.39.0A102	4.39.0A202	4.39.0A302	4.39.0A402	4.39.0A502	4.39.0A602
------	------------	------------	------------	------------	------------	------------

**Art. 390A / 3**

 N° 3 serraggi indipendenti  
 N° 3 independent clamping

**Art. 390 + n° 2 Art. 407**

+2 Art. 407

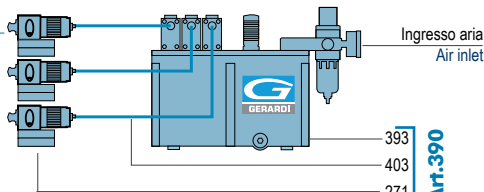
 Ingresso aria  
 Air inlet

Cod.	4.39.0A103	4.39.0A203	4.39.0A303	4.39.0A403	4.39.0A503	4.39.0A603
------	------------	------------	------------	------------	------------	------------

**Art. 390A / 4**

 N° 4 serraggi indipendenti  
 N° 4 independent clamping

**Art. 390 + n° 3 Art. 407**

+3 Art. 407

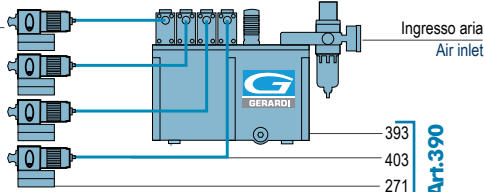
 Ingresso aria  
 Air inlet

Cod.	4.39.0A104	4.39.0A204	4.39.0A304	4.39.0A404	4.39.0A504	4.39.0A604
------	------------	------------	------------	------------	------------	------------

# COMANDO ELETTRICO - SOLENOID CONTROL

SINGOLO EFFETTO - cnc

SINGLE EFFECT da cnc

Tipo (grandezza) morsa / Vise type (size)

1	2	3	4	5	6
---	---	---	---	---	---

## Art. 391

N° 1 serraggio  
N° 1 clamping

**MORSA NON COMPRESA**  
VISE NOT INCLUDED

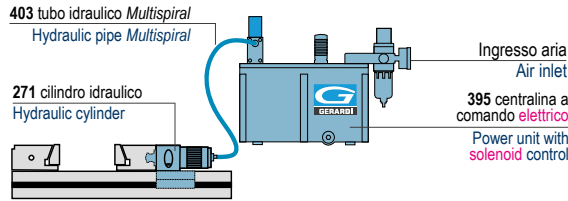

Cod.	4.39.11000	4.39.12000	4.39.13000	4.39.14000	4.39.15000	4.39.16000

Art. 395 + Art. 271 + Art. 403 (m 1,5)

## Art. 391 / 2

N° 2 serraggi contemporanei  
N° 2 simultaneously clamping

Art. 391 + n° 1 Art. 271

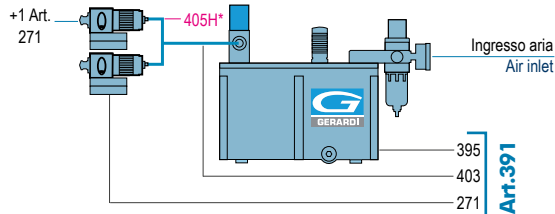

Cod.	4.39.11002	4.39.12002	4.39.13002	4.39.14002	4.39.15002	4.39.16002

\* Non incluso (Pag. 4.52) / Not included (Pag. 4.52)

## Art. 391 / 3

N° 3 serraggi contemporanei  
N° 3 simultaneously clamping

Art. 391 + n° 2 Art. 271

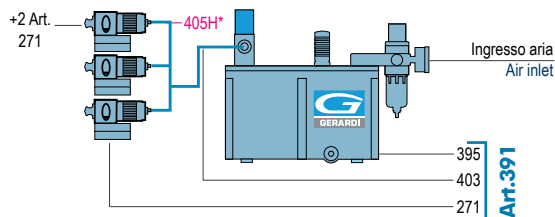

Cod.	4.39.11003	4.39.12003	4.39.13003	4.39.14003	4.39.15003	4.39.16003

\* Non incluso (Pag. 4.52) / Not included (Pag. 4.52)

## Art. 391 / 4

N° 4 serraggi contemporanei  
N° 4 simultaneously clamping

Art. 391 + n° 3 Art. 271

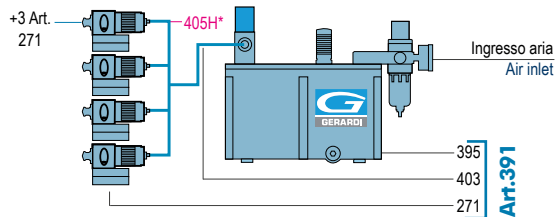

Cod.	4.39.11004	4.39.12004	4.39.13004	4.39.14004	4.39.15004	4.39.16004

\* Non incluso (Pag. 4.52) / Not included (Pag. 4.52)

## Art. 407A

Gruppo di serraggio indipendente  
Independent clamping group

Art. 271 + Art. 398 + Art. 403 (m 1,5)

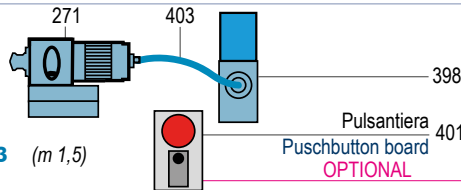

Cod.	4.40.7A100	4.40.7A200	4.40.7A300	4.40.7A400	4.40.7A500	4.40.7A600

Possibility to automate all STD / StandardFLEX / XL / Modular Element vises. (Art. 1E & Art. 1F except)

## Art. 391A / 2

N° 2 serraggi indipendenti  
N° 2 independent clamping

Art. 391 + n° 1 Art. 407A

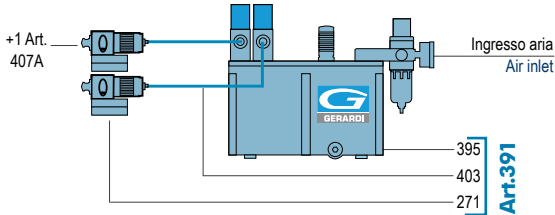

Cod.	4.39.1A102	4.39.1A202	4.39.1A302	4.39.1A402	4.39.1A502	4.39.1A602

## Art. 391A / 3

N° 3 serraggi indipendenti  
N° 3 independent clamping

Art. 391 + n° 2 Art. 407A

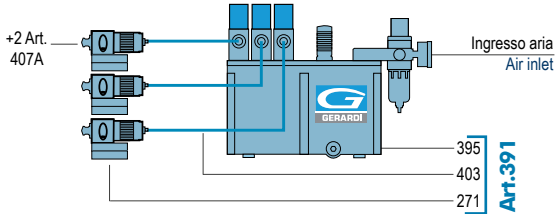

Cod.	4.39.1A103	4.39.1A203	4.39.1A303	4.39.1A403	4.39.1A503	4.39.1A603

## Art. 391A / 4

N° 4 serraggi indipendenti  
N° 4 independent clamping

Art. 391 + n° 3 Art. 407A

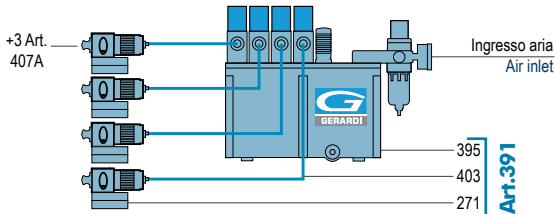

Cod.	4.39.1A104	4.39.1A204	4.39.1A304	4.39.1A404	4.39.1A504	4.39.1A604

**COMANDO PNEUMATICO - PNEUMATIC CONTROL**

SINGOLO EFFETTO

SINGLE EFFECT

Tipo (grandezza) morsa / Vise type (size)

1

2

3

4

5

6

**Art. 392**

N° 1 serraggio  
N° 1 clamping

**MORSA NON COMPRESA**  
**VICE NOT INCLUDED**

**Art. 392 + 271 + 402 + 403** (m 1,5)

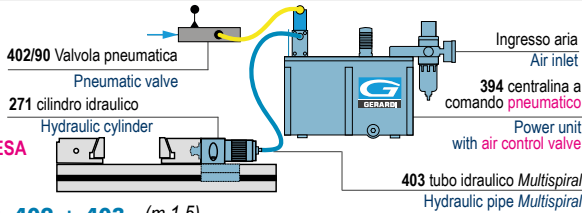

Cod. 4.39.21000 4.39.22000 4.39.23000 4.39.24000 4.39.25000 4.39.26000

\* Non incluso (Pag. 4.52) / Not included (Pag. 4.52)

**Art. 392 / 2**

N° 2 serraggi contemporanei  
N° 2 simultaneously clamping

**Art. 392 + n° 1 Art. 271**

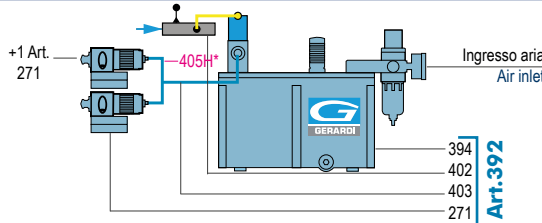

Cod. 4.39.21002 4.39.22002 4.39.23002 4.39.24002 4.39.25002 4.39.26002

\* Non incluso (Pag. 4.52) / Not included (Pag. 4.52)

**Art. 392 / 3**

N° 3 serraggi contemporanei  
N° 3 simultaneously clamping

**Art. 392 + n° 2 Art. 271**

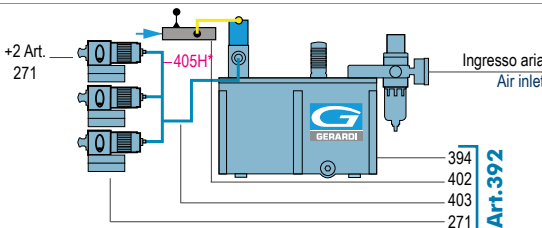

Cod. 4.39.21003 4.39.22003 4.39.23003 4.39.24003 4.39.25003 4.39.26003

\* Non incluso (Pag. 4.52) / Not included (Pag. 4.52)

**Art. 392 / 4**

N° 4 serraggi contemporanei  
N° 4 simultaneously clamping

**Art. 392 + n° 3 Art. 271**

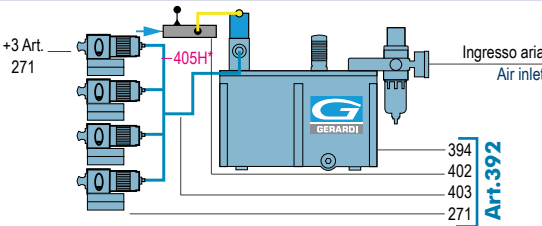

Cod. 4.39.21004 4.39.22004 4.39.23004 4.39.24004 4.39.25004 4.39.26004

\* Non incluso (Pag. 4.52) / Not included (Pag. 4.52)

**Art. 407B**

Gruppo di serraggio indipendente  
Independent clamping group

**Art. 271 + 396 + 402 + 403** (m 1,5)

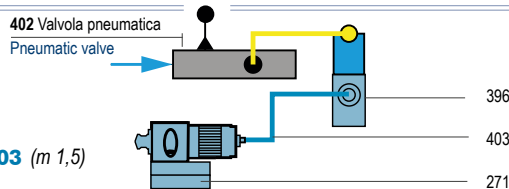

Cod. 4.40.7B100 4.40.7B200 4.40.7B300 4.40.7B400 4.40.7B500 4.40.7B600

**Possibilità di automatizzare tutte le morse STD / StandardFLEX / XL / Elementi modulari. (Esclusi Art.1E, Art.1F)**

**Art. 392A / 2**

N° 2 serraggi indipendenti  
N° 2 independent clamping

**Art. 392 + n° 1 Art. 407B**

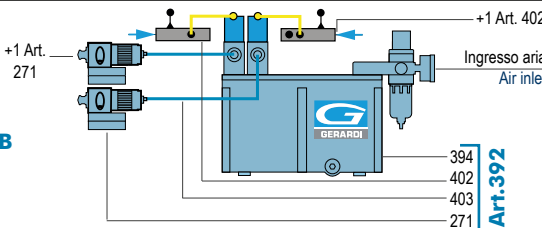

Cod. 4.39.2A102 4.39.2A202 4.39.2A302 4.39.2A402 4.39.2A502 4.39.2A602

**Art. 392A / 3**

N° 3 serraggi indipendenti  
N° 3 independent clamping

**Art. 392 + n° 2 Art. 407B**

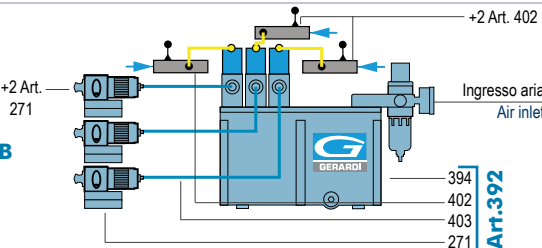

Cod. 4.39.2A103 4.39.2A203 4.39.2A303 4.39.2A403 4.39.2A503 4.39.2A603

**Art. 392A / 4**

N° 4 serraggi indipendenti  
N° 4 independent clamping

**Art. 392 + n° 3 Art. 407B**

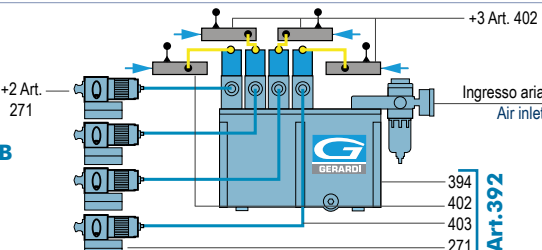

Cod. 4.39.2A104 4.39.2A204 4.39.2A304 4.39.2A404 4.39.2A504 4.39.2A604

# ACCESSORI e RICAMBI

## ACCESSORIES and SPARE PARTS

**N.B. Le centraline sono fornite senza olio**  
**N.B. The power units are supplied without oil**

### Art. 393

Centralina a comando **manuale singolo**  
Pressione max 450bar  
Con mantenimento e ripristino automatico della pressione desiderata

Power unit with **single manual** control  
Max pression 450bar  
Automatic retention and reset of desired pressure



Cod. 4.39.34500

### Art. 397

Blocco modulare per comando **manuale** aggiuntivo per ogni morsa extra

Modular block for **manual** control for each extra vise

Ingresso aria (Ø 8 - 7bar)  
Air inlet (Ø 8 - 7bar)



Cod. 4.39.70000

### Art. 397B

Blocco base per comando **manuale**  
Base block for **manual** control

Ingresso aria (Ø 8 - 7bar)  
Air inlet (Ø 8 - 7bar)



Cod. 4.39.7B000

### Art. 394

Centralina a comando **pneumatico remoto**  
(Tramite Art. 402 extra) - Pressione max 450bar  
Con mantenimento e ripristino automatico della pressione desiderata

Power unit with **remote pneumatic** control  
(Through Art. 402 extra) - Max pression 450bar  
Automatic retention and reset of desired pressure



Cod. 4.39.44500

Ingresso aria (Ø 8 - 7bar)  
Air inlet (Ø 8 - 7bar)



Ingresso aria (Ø 8 - 7bar)  
Air inlet (Ø 8 - 7bar)



### Art. 396

Blocco modulare per comando **pneumatico** aggiuntivo per ogni morsa extra

Modular block for **pneumatic** control for each extra vise



Cod. 4.39.60000

### Art. 396B

Blocco base per comando **pneumatico**  
Base block for **pneumatic** control



Cod. 4.39.6B000

### Art. 395

Centralina a comando **elettrico**  
Pressione max 450bar  
Con mantenimento e ripristino automatico della pressione desiderata

Power unit with **electrical** control  
Max pression 450bar  
Automatic retention and reset of desired pressure



Cod. 4.39.54500

Su richiesta:  
12V / 24V / ...V  
On request:  
12V / 24V / ...V

Ingresso aria (Ø 8 - 7bar)  
Air inlet (Ø 8 - 7bar)



Su richiesta:  
12V / 24V / ...V  
On request:  
12V / 24V / ...V

Ingresso aria (Ø 8 - 7bar)  
Air inlet (Ø 8 - 7bar)



### Art. 398

Blocco modulare per comando **elettrico** aggiuntivo per ogni morsa extra

Modular block for **electric** control for each extra vise



Cod. 4.39.80000

### Art. 398B

Blocco base per comando **pneumatico**  
Base block for **pneumatic** control



Cod. 4.39.8B000

# COMANDO MANUALE - MANUAL CONTROL

**DOPPIO EFFETTO**

**DOUBLE EFFECT**

Tipo (grandezza) morsa / Vise type (size)

1

2

3

4

5

6

## Art. 390B

403 tubo idraulico *Multispiral*  
Hydraulic pipe *Multispiral*

271D cilindro idraulico doppio effetto  
double effect hydraulic cylinder

N° 1 serraggio  
N° 1 clamping

**MORSA NON COMPRESA**  
**WISE NOT INCLUDED**

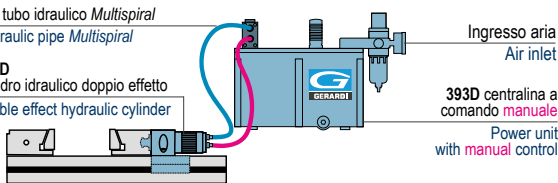

Cod. 4.39.0B100 4.39.0B200 4.39.0B300 4.39.0B400 4.39.0B500 4.39.0B600

**Art.393D + Art.271D + Art.403 (m 1,5)**

## Art. 390B/2

N° 2 serraggi **contemporanei**  
N° 2 **simultaneously** clamping

**Art. 390B + n° 1 Art.271D**

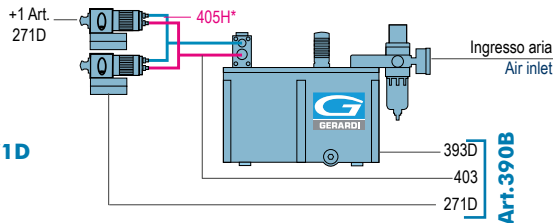

Cod. 4.39.0B102 4.39.0B202 4.39.0B302 4.39.0B402 4.39.0B502 4.39.0B602

\* Non incluso (Pag. 4.52) / Not included (Pag. 4.52)

## Art. 390B/3

N° 3 serraggi **contemporanei**  
N° 3 **simultaneously** clamping

**Art. 390B + n° 2 Art.271D**

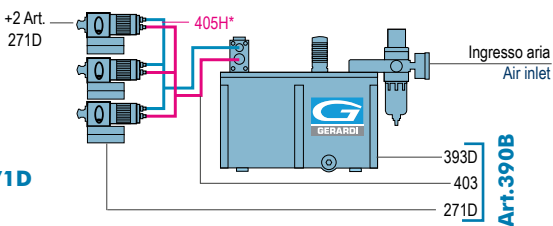

Cod. 4.39.0B103 4.39.0B203 4.39.0B303 4.39.0B403 4.39.0B503 4.39.0B603

\* Non incluso (Pag. 4.52) / Not included (Pag. 4.52)

## Art. 390B/4

N° 4 serraggi **contemporanei**  
N° 4 **simultaneously** clamping

**Art. 390B + n° 3 Art.271D**

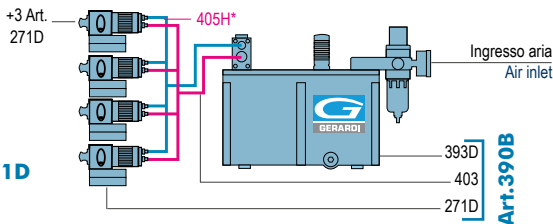

Cod. 4.39.0B104 4.39.0B204 4.39.0B304 4.39.0B404 4.39.0B504 4.39.0B604

\* Non incluso (Pag. 4.52) / Not included (Pag. 4.52)

## Art. 407C

Gruppo di serraggio **indipendente**  
**Independent** clamping group

**Art.271D + Art. 403 + Art. 397D (m 1,5)**

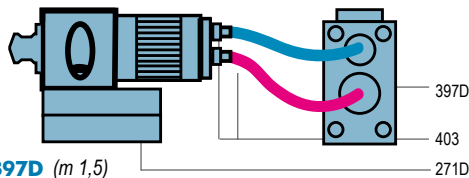

Cod. 4.40.7C100 4.40.7C200 4.40.7C300 4.40.7C400 4.40.7C500 4.40.7C600

**Possibilità di automatizzare tutte le morse STD / StandardFLEX / XL / Elementi modulari. (Esclusi Art.1E, Art.1F)**

## Art. 390C / 2

N° 2 serraggi **indipendenti**  
N° 2 **independent** clamping

**Art. 390C + n° 1 Art. 407C**

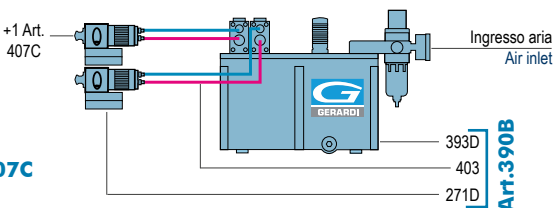

Cod. 4.39.0C102 4.39.0C202 4.39.0C302 4.39.0C402 4.39.0C502 4.39.0C602

## Art. 390C / 3

N° 3 serraggi **indipendenti**  
N° 3 **independent** clamping

**Art. 390C + n° 2 Art. 407C**

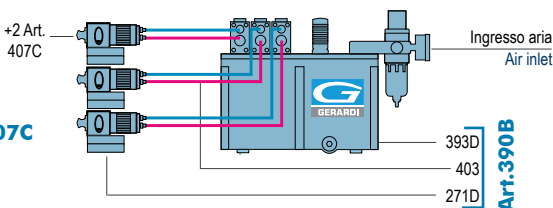

Cod. 4.39.0C103 4.39.0C203 4.39.0C303 4.39.0C403 4.39.0C503 4.39.0C603

## Art. 390C / 4

N° 4 serraggi **indipendenti**  
N° 4 **independent** clamping

**Art. 390C + n° 3 Art. 407C**

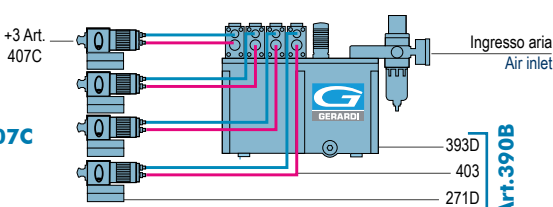

Cod. 4.39.0C104 4.39.0C204 4.39.0C304 4.39.0C404 4.39.0C504 4.39.0C604



# COMANDO ELETTRICO - SOLENOID CONTROL

**DOPPIO EFFETTO da cnc** **DOUBLE EFFECT by cnc**

Tipo (grandezza) morsa / Vise type (size)

1	2	3	4	5	6
---	---	---	---	---	---

## Art. 391B

N° 1 serraggio  
N° 1 clamping

**MORSA NON COMPRESA**  
**VICE NOT INCLUDED**

403 tubo idraulico Multispiral  
Hydraulic pipe Multispiral

271D cilindro idraulico doppio effetto  
double effect hydraulic cylinder

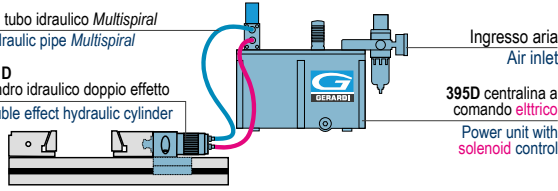

Ingresso aria  
Air inlet

395D centralina a comando elettrico  
Power unit with solenoid control

Cod. 4.39.1B100 4.39.1B200 4.39.1B300 4.39.1B400 4.39.1B500 4.39.1B600

Art. 395D + Art.271D + Art. 403 (m 1,5)

## Art. 391B / 2

N° 2 serraggi contemporanei  
N° 2 simultaneously clamping

Art. 391B + n° 1 Art.271D

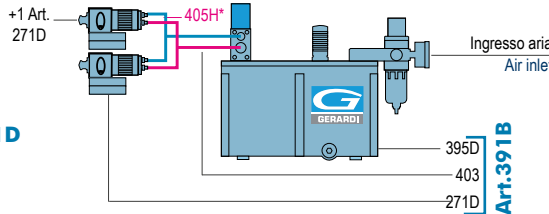

Cod. 4.39.1B102 4.39.1B202 4.39.1B302 4.39.1B402 4.39.1B502 4.39.1B602

\* Non incluso (Pag. 4.52) / Not included (Pag. 4.52)

## Art. 391B / 3

N° 3 serraggi contemporanei  
N° 3 simultaneously clamping

Art. 391B + n° 2 Art.271D

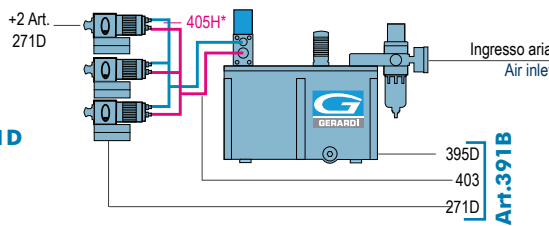

Cod. 4.39.1B103 4.39.1B203 4.39.1B303 4.39.1B403 4.39.1B503 4.39.1B603

\* Non incluso (Pag. 4.52) / Not included (Pag. 4.52)

## Art. 391B / 4

N° 4 serraggi contemporanei  
N° 4 simultaneously clamping

Art. 391B + n° 3 Art.271D

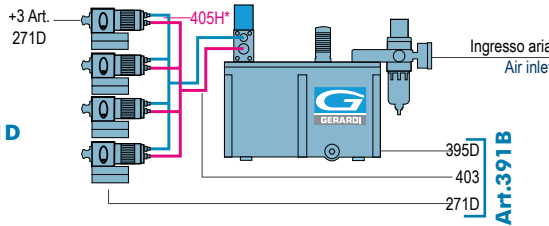

Cod. 4.39.1B104 4.39.1B204 4.39.1B304 4.39.1B404 4.39.1B504 4.39.1B604

\* Non incluso (Pag. 4.52) / Not included (Pag. 4.52)

## Art. 407D

Gruppo di serraggio indipendente  
Independent clamping group

Art.271D + Art. 403 + Art.398D (m 1,5)

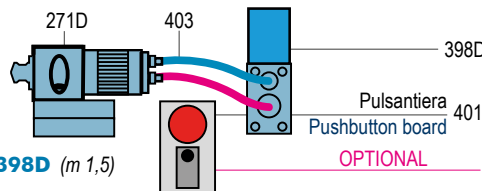

Cod. 4.40.7D100 4.40.7D200 4.40.7D300 4.40.7D400 4.40.7D500 4.40.7D600

Pulsantiera  
Pushbutton board

401

OPTIONAL

Possibility to automate all STD / StandardFLEX / XL / Modular Element vises. (Art.1E & Art.1F except)

## Art. 391C / 2

N° 2 serraggi indipendenti  
N° 2 independent clamping

Art. 391C + n° 1 Art. 407D

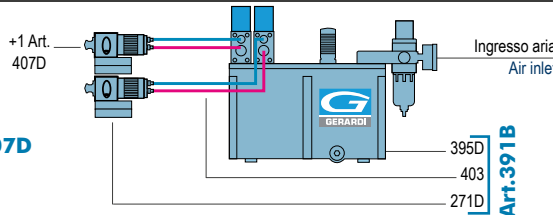

Cod. 4.39.1C102 4.39.1C202 4.39.1C302 4.39.1C402 4.39.1C502 4.39.1C602

## Art. 391C / 3

N° 3 serraggi indipendenti  
N° 3 independent clamping

Art. 391C + n° 2 Art. 407D

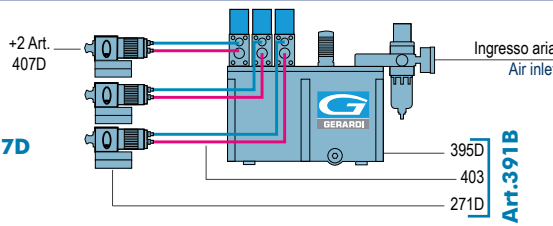

Cod. 4.39.1C103 4.39.1C203 4.39.1C303 4.39.1C403 4.39.1C503 4.39.1C603

## Art. 391C / 4

N° 4 serraggi indipendenti  
N° 4 independent clamping

Art. 391C + n° 3 Art. 407D

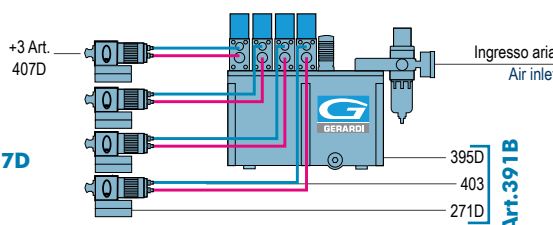

Cod. 4.39.1C104 4.39.1C204 4.39.1C304 4.39.1C404 4.39.1C504 4.39.1C604

# COMANDO PNEUMATICO - PNEUMATIC CONTROL

**DOPPIO EFFETTO**

**DOUBLE EFFECT**

Tipo (grandezza) morsa / Vise type (size)

**1**

**2**

**3**

**4**

**5**

**6**

## Art. 392B

N° 1 serraggio  
N° 1 clamping

**MORSA NON COMPRESA**  
**WISE NOT INCLUDED**

**Art. 394D + 271D + 402 + 403 (m 1,5)**

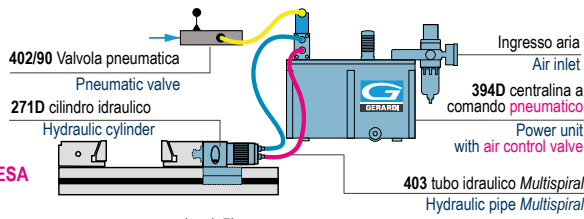

Cod. 4.39.2B100 4.39.2B200 4.39.2B300 4.39.2B400 4.39.2B500 4.39.2B600

\* Non incluso (Pag. 4.52) / Not included (Pag. 4.52)

## Art. 392B / 2

N° 2 serraggi contemporanei  
N° 2 simultaneously clamping

**Art. 392B + n° 1 Art.271D**

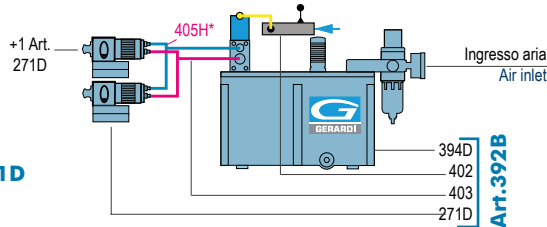

Cod. 4.39.2B102 4.39.2B202 4.39.2B302 4.39.2B402 4.39.2B502 4.39.2B602

\* Non incluso (Pag. 4.52) / Not included (Pag. 4.52)

## Art. 392B / 3

N° 3 serraggi contemporanei  
N° 3 simultaneously clamping

**Art. 392B + n° 2 Art.271D**

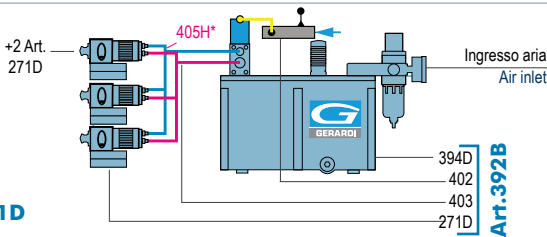

Cod. 4.39.2B103 4.39.2B203 4.39.2B303 4.39.2B403 4.39.2B503 4.39.2B603

\* Non incluso (Pag. 4.52) / Not included (Pag. 4.52)

## Art. 392B / 4

N° 4 serraggi contemporanei  
N° 4 simultaneously clamping

**Art. 392B + n° 3 Art.271D**

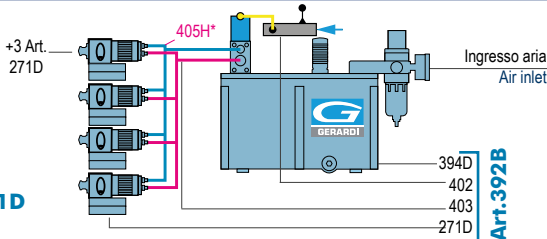

Cod. 4.39.2B104 4.39.2B204 4.39.2B304 4.39.2B404 4.39.2B504 4.39.2B604

\* Non incluso (Pag. 4.52) / Not included (Pag. 4.52)

## Art. 407E

Gruppo di serraggio indipendente  
Independent clamping group

**Art.271D + 396D + 402 + 403 (m 1,5)**

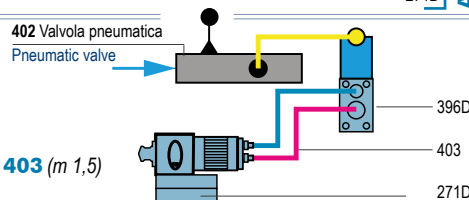

Cod. 4.40.7E100 4.40.7E200 4.40.7E300 4.40.7E400 4.40.7E500 4.40.7E600

### Possibilità di automatizzare tutte le morse STD / StandardFLEX / XL / Elementi modulari. (Esclusi Art.1E, Art.1F)

## Art. 392C / 2

N° 2 serraggi indipendenti  
N° 2 independent clamping

**Art. 392C + n° 1 Art. 407B**

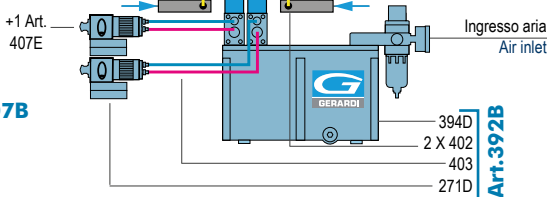

Cod. 4.39.2C102 4.39.2C202 4.39.2C302 4.39.2C402 4.39.2C502 4.39.2C602

## Art. 392C / 3

N° 3 serraggi indipendenti  
N° 3 independent clamping

**Art. 392C + n° 2 Art. 407B**

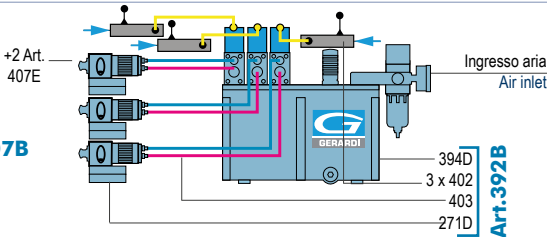

Cod. 4.39.2C103 4.39.2C203 4.39.2C303 4.39.2C403 4.39.2C503 4.39.2C603

## Art. 392C / 4

N° 4 serraggi indipendenti  
N° 4 independent clamping

**Art. 392C + n° 3 Art. 407B**

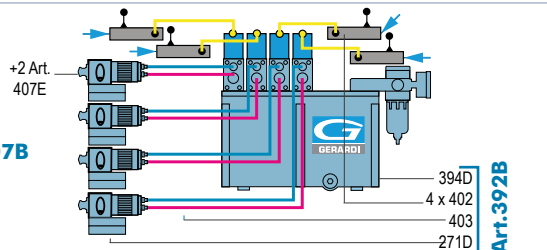

Cod. 4.39.2C104 4.39.2C204 4.39.2C304 4.39.2C404 4.39.2C504 4.39.2C604

# ACCESSORI e RICAMBI

## ACCESSORIES and SPARE PARTS

**N.B. Le centraline sono fornite senza olio**  
**N.B. The power units are supplied without oil**

### Art. 393D

Centralina a comando **manuale doppio**  
Pressione max 450bar  
Con mantenimento e ripristino automatico della pressione desiderata

Power unit with **double manual** control  
Max pression 450bar  
Automatic retention and reset of desired pressure



Cod. 4.39.3D450

### Art. 397D

Blocco modulare per comando **manuale** aggiuntivo per ogni morsa extra

Modular block for **manual** control for each extra vise

Ingresso aria (Ø 8 - 7bar)  
Air inlet (Ø 8 - 7bar)



Cod. 4.39.7D000

### Art. 397C

Blocco base per comando **manuale**  
Base block for **manual** control

Ingresso aria (Ø 8 - 7bar)  
Air inlet (Ø 8 - 7bar)



Cod. 4.39.7C000

### Art. 394D

Centralina a comando **pneumatico remoto doppio** (Tramite Art. 402 extra) - Pressione max 450bar  
Con mantenimento e ripristino automatico della pressione desiderata

Power unit with **double remote pneumatic** control (Through Art. 402 extra) - Max pression 450bar  
Automatic retention and reset of desired pressure



Cod. 4.39.4D450

Ingresso aria (Ø 8 - 7bar)  
Air inlet (Ø 8 - 7bar)



Ingresso aria (Ø 8 - 7bar)  
Air inlet (Ø 8 - 7bar)



### Art. 396D

Blocco modulare per comando **pneumatico** aggiuntivo per ogni morsa extra

Modular block for **pneumatic** control for each extra vise

Ingresso aria (Ø 8 - 7bar)  
Air inlet (Ø 8 - 7bar)



Cod. 4.39.6D000

### Art. 396C

Blocco base per comando **pneumatico**  
Base block for **pneumatic** control

Ingresso aria (Ø 8 - 7bar)  
Air inlet (Ø 8 - 7bar)



Cod. 4.39.6C000

### Art. 395D

Centralina a comando **elettrico**  
Pressione max 450bar  
Con mantenimento e ripristino automatico della pressione desiderata

Power unit with **electrical** control  
Max pression 450bar  
Automatic retention and reset of desired pressure



Cod. 4.39.5D450

Su richiesta:  
12V / 24V / ...V  
On request:  
12V / 24V / ...V

Ingresso aria (Ø 8 - 7bar)  
Air inlet (Ø 8 - 7bar)



Cod. 4.39.8D000

### Art. 398C

Blocco base per comando **pneumatico**  
Base block for **pneumatic** control

Su richiesta:  
12V / 24V / ...V  
On request:  
12V / 24V / ...V

Ingresso aria (Ø 8 - 7bar)  
Air inlet (Ø 8 - 7bar)



Cod. 4.39.8C000

### Art. 398D

Blocco modulare per comando **elettrico** aggiuntivo per ogni morsa extra

Modular block for **electric** control for each extra vise

# ACCESSORI e RICAMBI

## ACCESSORIES and SPARE PARTS

**Art. 399**

 Gruppo filtro riduttore più lubrificatore  
 Compressed air preparation unit

Cod. 4.39.90000

**Art. 400**

 Pedale bistabile  
 Two positions foot pedal

Cod. 4.40.00000

**Art. 401**

 Pulsantiera per 1 azionamento  
 Puschbutton board for one control operation

Cod. 4.40.10000

**Art. 402**

 Valvola pneumatica frontale, 2 vie  
 Frontal pneumatic valve, 2 ways

Cod. 4.40.20000

**Art. 402/90**

 Distributore leva angolare a 90°, 3 vie  
 90° angular valve, 3 ways

Cod. 9.40.29000

**Art. 405H**

Per ogni metro extra / For each extra meter: € 10

 Coduttura Tubolare in acciaio zincato (m 1,0)  
 Suitable galvanized steel pipe (m 1,0)

Ø 6

Cod. 4.40.5H000

**Art. 403**

Per ogni metro extra / For each extra meter: € 116

 Tubo idraulico Multispiral 760bar completo di attacco rapido Art. 270A (m 1,5)  
 Hydraulic pipe Multispiral 760 bar complete with rapid connection Art. 270A (m 1,5)

Cod. 4.40.30000

 Con le centraline a DOPPIO EFFETTO l'attacco rapido NON è incluso  
 With DOUBLE EFFECT power unit the quick connection is NOT included

**Art. 404**

 Manometro 400bar  
 Oil pressure gauge 400bar

Cod. 4.40.40000

4

# ACCESSORI e RICAMBI

## ACCESSORIES and SPARE PARTS

### Art. 270A

Attacco idraulico rapido femmina  
Quick hydraulic female connection



Cod. 4.27.0A000

### Art. 270B

Innesto idraulico rapido maschio  
Quick hydraulic male connection



Cod. 4.27.0B000

### Art. ID03

Raccordo idraulico a "L" maschio cilindrico Ø6 - 1/4" Gas  
"L" hydraulic male parallel adaptor Ø6 - 1/4" Gas



Cod. 9.ID.03000

### Art. ID04

Raccordo idraulico a "T" centrale maschio cilindrico Ø6 - 1/4" Gas  
"T" hydraulic male parallel adaptor Ø6 - 1/4" Gas



Cod. 9.ID.04000

### Art. ID05

Riduzione idraulica Ø6 - 1/4" Gas  
Hydraulic straight male adaptor Ø6 - 1/4" Gas



Cod. 9.ID.05000

### Art. 505

Pressostato 400bar  
Pressure switch 400bar



Cod. 0.50.50000

### Art. 272A

Indicatore di forza kN  
Force indicator kN



Cod. 4.27.2A600

### Art. 272

Cella di carico **completa** per controllo forza di bloccaggio delle morse  
**Complete** loading cells to check vise clamping force

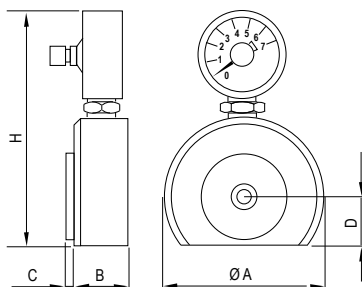

Ø A	90
B	37
C	4
D	30
E	c.a. 150

kN 60

Cod. 4.27.26000

# SERVOCOMANDI OLEODINAMICI / HYDRAULIC SERVO UNITS

**Tipo (grandezza) morsa / Vise type (size)**
**1      2      3      4      5      6**
**Art. 271**

 Supporto di serraggio con cilindro idraulico  
 Clamping support with hydraulic cylinder  
**SEMPLICE EFFETTO - SIMPLE EFFECT**



Cod.	2.27.11000	2.27.12000	2.27.13000	2.27.14000	2.27.15000	2.27.16000
Corsa Stroke	32	26			40	

**Art. 271D**

 Supporto di serraggio con cilindro idraulico **DOPPIO EFFETTO**  
 Clamping support with hydraulic cylinder **DOUBLE EFFECT**

Cod.	2.27.1D100	2.27.1D200	2.27.1D300	2.27.1D400	2.27.1D500	2.27.1D600
Corsa Stroke	20	33			40	

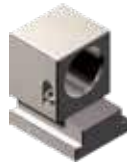
**Art. 283A**

 Supporto di serraggio per cilindro idraulico  
 Clamping support for hydraulic cylinder

Cod.	2.28.3A100	2.28.3A200	2.28.3A300	2.28.3A400	2.28.3A500	2.28.3A600
------	------------	------------	------------	------------	------------	------------

**Art. 285**

 Cilindro idraulico a semplice effetto.  
 Serraggio idraulico e apertura meccanica  
 Hydraulic cylinder single acting.  
 Hydraulic clamping and mechanical opening

Pressione MAX MAX pressure	450 bar - 6525 psi					
Ø Pistone Ø Piston	20	30		36		
Area effettiva (cm2) effective area (cm2)	3,14	7,07		10,17		
Cod.	2.28.51000	2.28.52000	2.28.53000	2.28.55000		
Corsa Stroke	32	26		40		

**Art. 569**

 Cilindro idraulico a doppio effetto.  
 Apertura e chiusura idrauliche  
 Hydraulic cylinder double acting.  
 Hydraulic opening and clamping

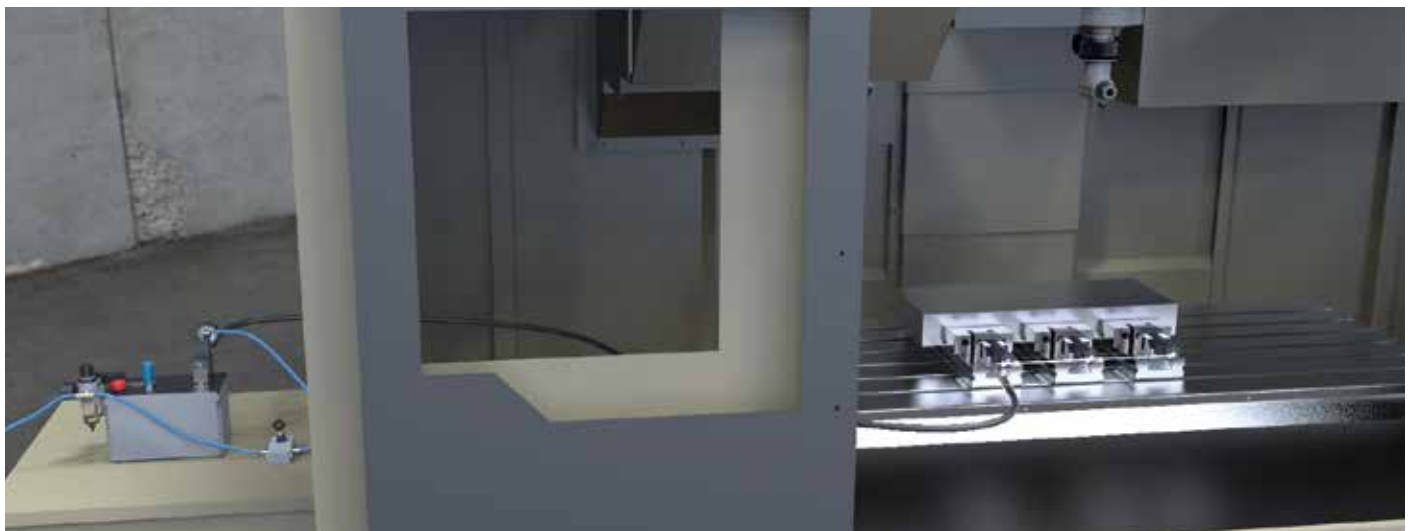

Pressione MAX MAX pressure	450 bar - 6525 psi					
Ø Pistone Ø Piston	20	30		32		
Area effettiva (cm2) effective area (cm2)	3,14	7,07		8,04		
Cod.	1.56.91000	1.56.92000	1.56.93000	1.56.95000		
Corsa Stroke	20	33		40		

*Specifico per sistemi robotizzati - Specific for robotic applications*
**Esempi di applicazione / Typical arrangements**

 Morse Modulari di Precisione accoppiabili ed allineabili per serraggi multipli Pneumoidraulici (Serie StandardMatic)  
 Precision Modular vises matchable for gang operations and pneumohydraulic clamping (StandardMatic series)

# SERRAGGIO IDRAULICO HYDRAULIC CLAMPING

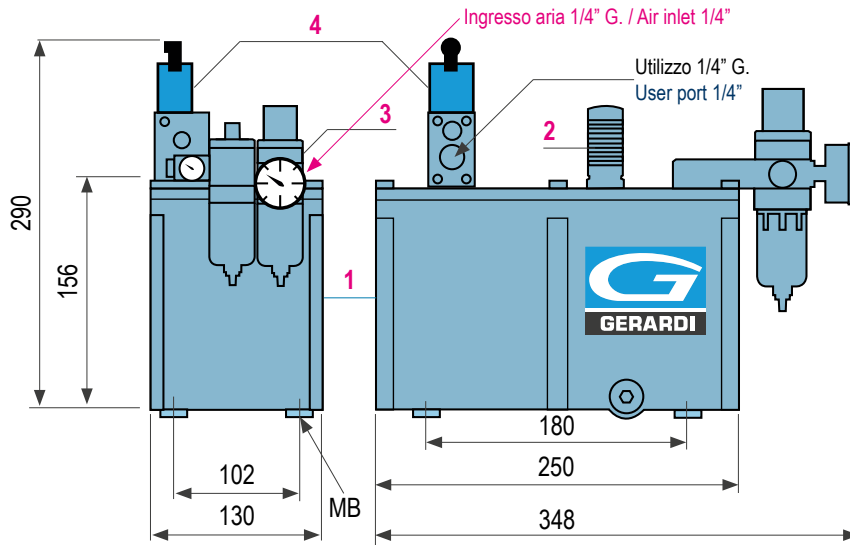
La centralina per serraggi idraulici ed i suoi derivati, nasce per soddisfare tutte le esigenze connesse all'azionamento di cilindri oleodinamici ove sia richiesta bassa portata ed elevate pressioni. La particolare forma costruttiva della centralina permette di ottenere, in ingombri estremamente contenuti, un impianto di elevate prestazioni. L'elemento pompante utilizzato consente, grazie ai particolari criteri costruttivi, di collocare la centralina in ambienti altamente ostili come, per esempio, l'area di lavoro di macchine utensili. L'esclusivo sistema modulare di controllo del flusso idraulico permette di comandare separatamente, con una sola unità, fino a sei utilizzi distinti.

The hydropneumatic power unit for hydraulic clamping devices and its bi-products are designed to meet all needs regarding the powering of hydraulic cylinders where low flow rates and high pressures are required. The special design shape of the power unit is such that a high performance system can be implemented taking up very little space. Thanks to the special design principles, the pump section adopted allows the hydropneumatic power unit to be installed in very hostile environments, such as the work area of machine tools, etc. The unique modular hydraulic flow control system allows controlling up to 6 separate users from just the one power unit.



## CARATTERISTICHE TECNICHE

## SPECIFICATION

### Centralina tipo / Power unit type 450 T 2/3/4

Pressione massima aria: Max permissible air pressure:	7 bar
Pressione aria consigliata: Recommended air pressure:	5,5 bar
Tipo di olio raccomandato: idraulico Recommended grade of oil: hydraulic	68 CSt
Portata Deliveries	0,9 l / min
Capacità serbatoio Tank capacity	3 l
Delta massimo su pilotaggi elettrici: Max delta on electric pilot section:	+ 10% - 5%
Pressione minima su pilotaggio pneumatico: Minimum pressure on pneumatic control:	5 bar
Pressione massima consentita per eventuale pilotaggio elettroidraulico: Max pressure for elettrohydraulic control:	150 bar
Numero massimo consigliato di utilizzi: Max permissible air pressure	4

La pompa nella versione base viene fornita completa di:

- serbatoio in teflon 1
- tappo di carica
- silenziatore 2
- attacco di alimentazione aria del tipo ad innesto rapido D8 3
- un blocco di comando oleodinamico 4

The pump in its basic version is supplied complete with:

- teflon tank 1
- fill plug
- silencer 2
- quick acting air connector fitting type D8 3
- hydraulic control block 4

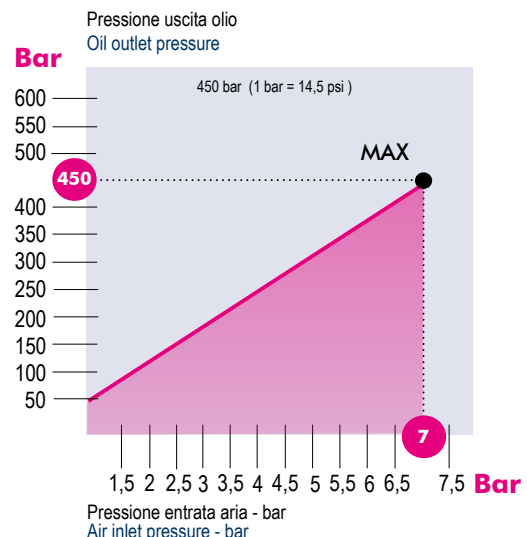

## Diagrammi di serraggio / Clamping diagrams

# StandardMatic

### Diagrammi di serraggio pneumoidraulici ed elettroidraulici

### Diagram pneumo-hydraulic and electro-hydraulic clamping

#### Morse tipo 1 Vises type

# 1

Cilindro idraulico Art. 285 - 569 Ø interno 20 mm - Superficie efficace 3,14 cm<sup>2</sup>  
 Hydraulic cylinder Art. 285 - 569 Cylinder I.D. 20 mm - Effective area 3,14 cm<sup>2</sup>

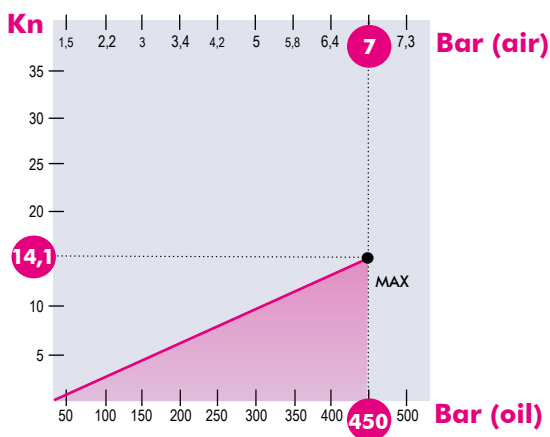

#### Morse tipo 2-3-4 Vises type

# 2-3-4

Cilindro idraulico Art. 285 - 569 Ø interno 30 mm - Superficie efficace 7,07 cm<sup>2</sup>  
 Hydraulic cylinder Art. 285 - 569 Cylinder I.D. 30 mm - Effective area 7,07 cm<sup>2</sup>

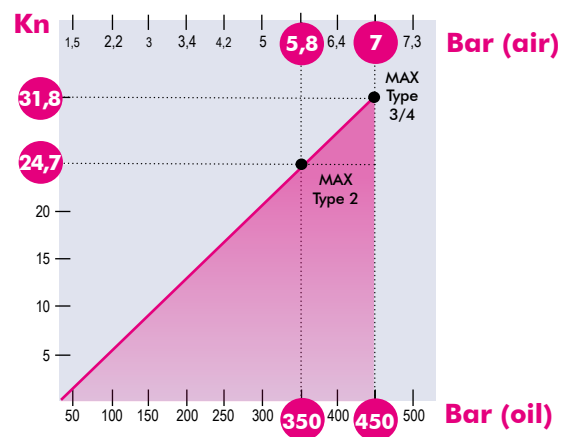

#### Morse tipo 5-6 Vises type

# 5-6

Cilindro idraulico Art. 285 Ø interno 36 mm - Superficie efficace 10,17 cm<sup>2</sup>  
 Cilindro idraulico Art. 569 Ø interno 32 mm - Superficie efficace 8,04 cm<sup>2</sup>  
 Hydraulic cylinder Art. 285 Cylinder I.D. 36 mm - Effective area 10,17 cm<sup>2</sup>  
 Hydraulic cylinder Art. 569 Cylinder I.D. 32 mm - Effective area 8,04 cm<sup>2</sup>

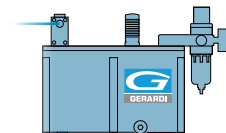
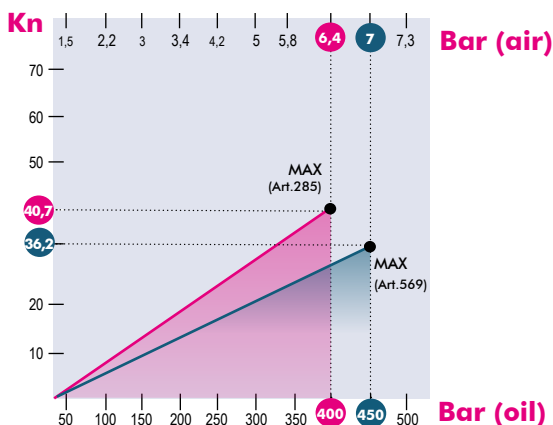

Art. 393

Art. 393D

#### Serraggi tramite gruppi di comando pneumatici e idraulici

I diagrammi seguenti consentono di determinare le forze di serraggio ottenibili con le morse di varia grandezza (da 1 a 6), provviste di vari dispositivi di bloccaggio pneumoidraulici ed elettroidraulici, in funzione della pressione dei fluidi (aria e olio). Con centralina pneumoidraulica (Max pressione 450bar)

#### Clamping through pneumo-hydraulic and hydraulic clamping devices

The following diagrams give the clamping force that can be obtained with each vise type (size 1 to 6) when equipped with pneumo-hydraulic and electro-hydraulic blocking devices, as a function of the fluid pressure (air or oil). With pneumo-hydraulic power unit (Max pressure 450bar)

NB: Alcuni fattori, come la lubrificazione, lo staffaggio, gli attriti ed altro, possono modificare i valori indicati fino a  $\pm 10\%$ . Per un corretto utilizzo non superare i valori indicati nel grafico  
 Some factor as lubrication, clamping on the machine table, frictions and more can modify above values within a  $\pm 10\%$  range. For optimum operation do not exceed chart values.