

OWNERS MANUAL

BS1500PANO-3D



29"/49"/59"/78" Three sides Viewing Electric Fire

AC 220-240V 50Hz 1400-1600W

⚠ WARNING

Read and understand this entire owner's manual, including all safety information, before plugging in or using this product. Failure to do so could result in fire, electric shock, or serious personal injury.

⚠ CAUTION

Keep this owner's manual for future reference. If you sell or give this product away, make sure this manual accompanies this product.

IMPORTANT SAFETY INFORMATION!

⚠ WARNING

When using electrical appliances basic precautions should always be followed to reduce the risk of fire, electric shock and injury to persons, including the following:

- Read all instructions before using this heater.
- This heater is hot when in use. To avoid burning, do not touch hot surface. If provided, use handles when moving this heater. Keep combustible materials, such as furniture, pillows, bedding, papers, clothes, and curtains at least 1 m from the front of the heater and keep them away from the sides and rear. In order to avoid overheating, do not cover the heater.
- Extreme caution is necessary when any heater is used near children or the infirm and whenever the heater is left operating and unattended.
- Always unplug heater when not in use.
- Do not operate any heater with a damaged cord or plug or after the heater malfunctions, has been dropped damaged in any manner, return heater to authorized service facility for examination, electrical or mechanical adjustment, or repair.
- Indoor use only, do not use outdoors.
- This heater is not intended for use in bathrooms, laundry areas and similar indoor locations. Never locate heater where it may fall into a bathtub or other water container.
- Do not run cord under carpeting. Do not cover cord with throw rugs, runners, or similar coverings. Arrange cord away from traffic area and where it will not be tipped over.
- To disconnect heater, turn controls to off, then remove plug from outlet.
- Do not inset or allow foreign objects to enter any ventilation or exhaust opening as this may cause an electric shock or fire, or damage the heater.
- To prevent a possible fire, do not block air intakes or exhaust in any manner. Do not use on soft surfaces, like a bed, where openings many become blocked.
- A heater has hot and arcing or sparking parts inside. Do not use it in areas where gasoline, or flammable liquids are used or stored.
- Use this heater only as describes in this manual. Any other use not recommended by the manufacturer may cause fire, electric shock, or injury to persons.
- DANGER-HIGH Temperatures may be generated under certain abnormal conditions. Do not partially or fully cover or obstruct the front of this heater.
- Replacement of the lamps should be done only while the heater is disconnected from the supply circuit.
- This appliance is not intended for use by persons (including children) with reduced physical, sensory or capabilities, or lack of experience and knowledge, unless they have been given supervision or instruction concerning use of the appliance by a person responsible for their safety. Children should be supervised to ensure that they do not play with the appliance.
- CAUTION: In order to avoid a hazard due to inadvertent resetting of the thermal cut-out, this appliance must not be supplied through an external switching device, such as a timer, or connected to a circuit that is regularly switched on and off by the utility.

Preparation







This product includes a **GLASS panel!** Always use **extreme caution** when handling glass. Failure to do so could result in **personal injury** or **property damage**.

Remove all parts and hardware from the carton and place them on a clean, soft, dry surface. Parts and assembly steps are grouped for free-standing or wall-hanging use. Check the parts list to make sure nothing is missing. Dispose of packaging materials properly. Please recycle whenever possible.

You will need the following tools (not included): Phillips screwdriver; stud finder; level; tape measure; electric drill; 1/4" wood drill bit, hammer.

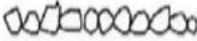
Parts and Hardware

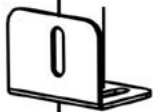
 <p>A – Fireplace</p>	 <p>B – Wood Screws</p>	 <p>C – Drywall Anchors</p>
 <p>Decorative Pebbles</p>		
 <p>E - Decorative Crystals (Small&Big)</p>	 <p>F – Remote Control</p>	 <p>G – Metal brackets</p>

Specification and Dimension

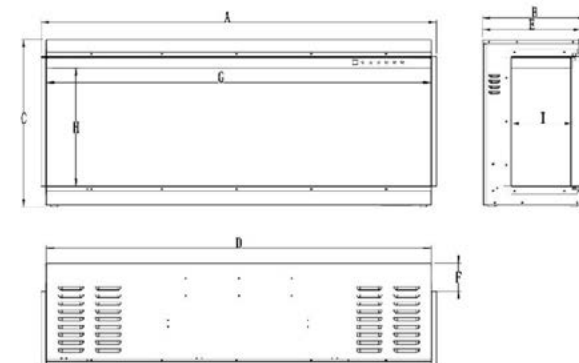

PRODUCT DIMENSIONS									
Model Number	A	B	C	D	E	F	G	H	I
BS700PANO	29"	12.5"	28.5"	27.8"	11.87"	3.5"	27.5"	22.4"	7"
	73.5cm	31.7cm	72.4cm	70.5cm	30.2cm	9cm	70.0cm	56.7cm	18cm
BS1250PANO	50"	13"	21.2"	48.8"	12.5"	3.5"	48.6"	15"	7.7"
	127cm	33.2cm	54cm	124cm	31.7cm	9cm	123.5cm	38.1cm	19.5cm
BS1500PANO	60"	13"	21.2"	58.8"	12.5"	3.5"	58.6"	15"	7.7"
	152.4cm	33.2cm	54cm	149.4cm	31.7cm	9cm	148.9cm	38.1cm	19.5cm
BS2000PANO-3D	78"	13"	21.2"	77.6"	12.5"	3.5"	77.36"	15"	7.7"
	200cm	33.2cm	54cm	197cm	31.7cm	9cm	196.5cm	38.1cm	19.5cm

Installation and Assembly

Your appliance is a recessed and/or mantel installed appliance. Select a suitable location that is not susceptible to moisture and is away from drapes, furniture and high traffic areas.

NOTE: Follow all National and local electrical codes.

MINIMUM CLEARANCE TO COMBUSTIBLES

Measurements are taken from the glass front.			
Bottom	0"	Top	11.8" (300mm) to mantel
Sides	0"	Top	11.8" (300mm) to ceiling
Back	0"		

MINIMUM MANTEL CLEARANCES

WARNING

WHEN USING PAINT OR LACQUER TO FINISH THE MANTEL, THE PAINT OR LACQUER MUST BE HEAT RESISTANT TO PREVENT DISCOLOURATION.

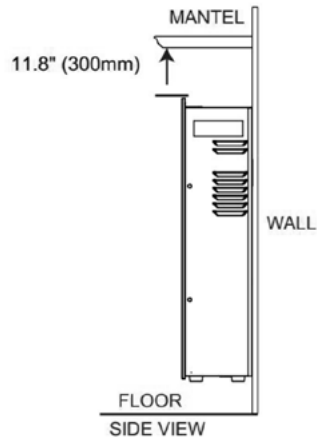

Installation for 3 Sided Viewing

1. The fireplace is fixed with fending bars and panels on the left and right side.

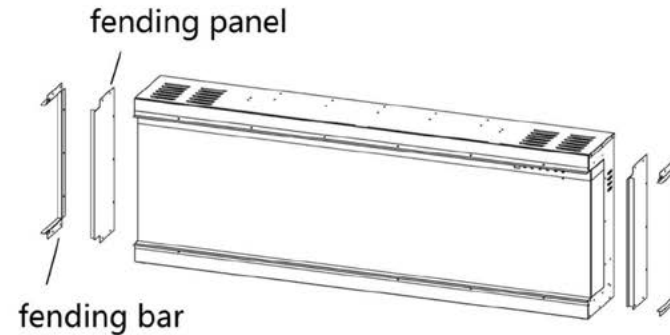
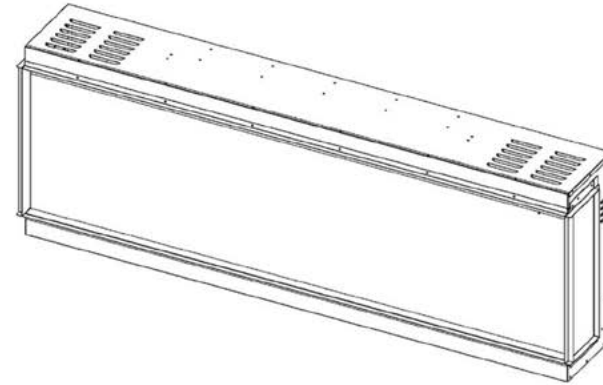

2. Take off the fending bars and panels if you want to view the fire from three sides.

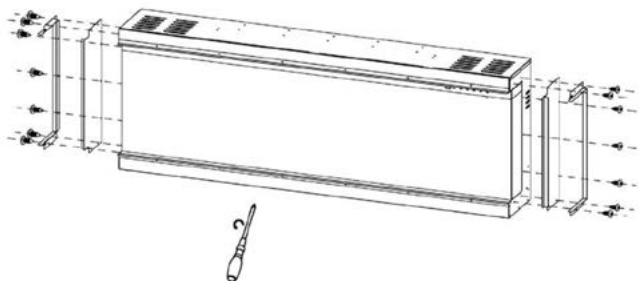

3. Fix back the fending bars after the panels are removed.

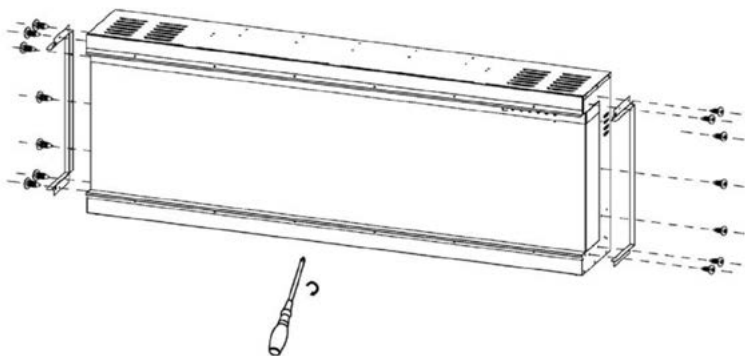

4. Remove the screws from the fireplace as shown in the picture below.

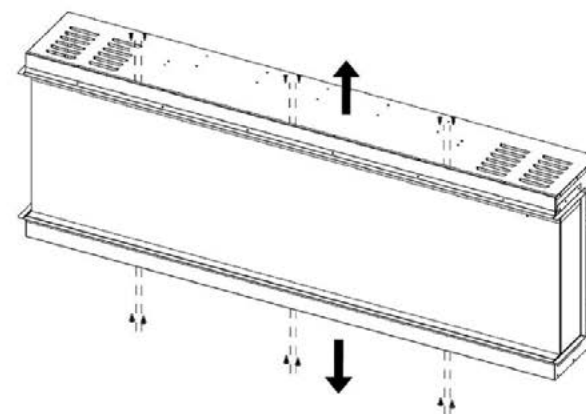

5. Fix the brackets with the screws in the previous step.

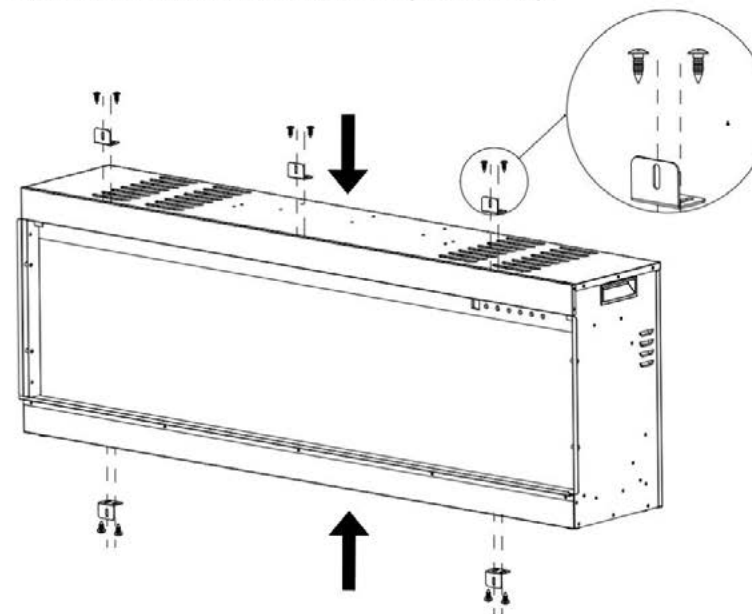

6. Make an opening for the fireplace according to requested measurement.

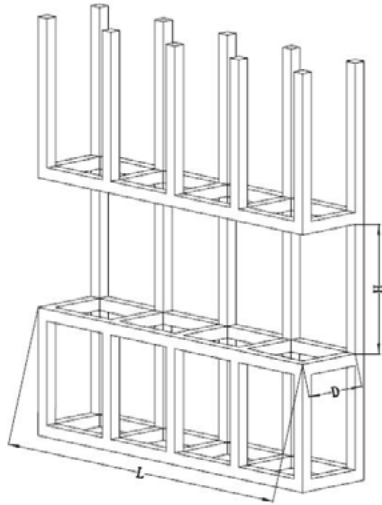

Model Number	L	H	D
BS700PANO	28" 71cm	28.75" 73cm	12.25" 31.2cm
BS1250PANO	48.8" 124cm	21.5" 54.5cm	13.4" 34cm
BS1500PANO	58.8" 149.4cm	21.5" 54.5cm	13.4" 34cm
BS2000PANO-3D	77.6" 197cm	21.5" 54.5cm	13.4" 34cm

7. Insert the fireplace into the wall opening. Drive the mounting screws into the brackets and the wall studs. Plug in and check if the fireplace works properly. If so, move on to next step.

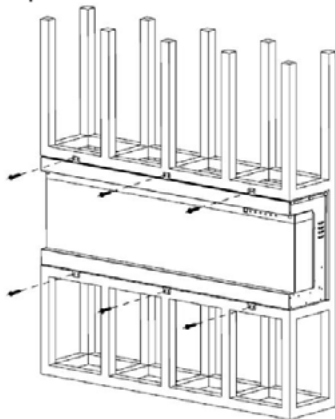

8. Cover the glass panel with protective plastic bag and install plywood or drywall.

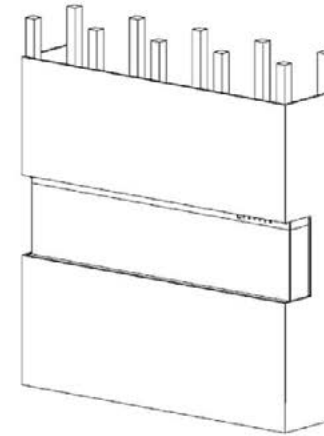

9. Decorate the plywood or drywall with glazed tile, wallpaper, etc.



Installation for Front and Right Side Viewing

1. To view the fireplace from front and right side, you need to take off the fending panel on the right side and keep the left side close to a wall.

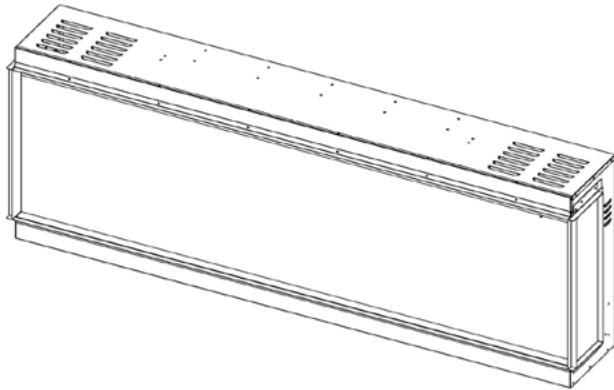

2. Remove the 7 screws on the right side. Take off the fending bar and panel.

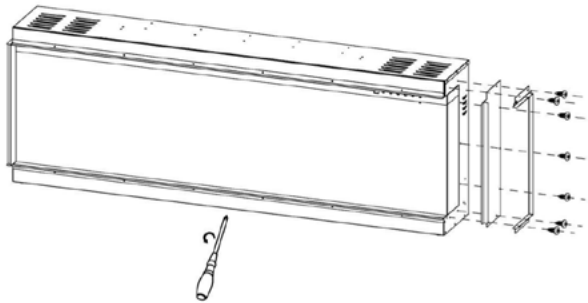

3. Fix back the fending bar after the panel is removed.

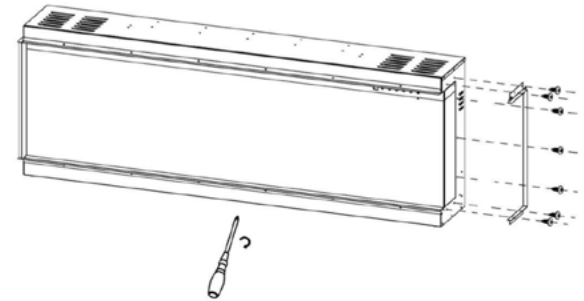

4. Remove the screws from the fireplace as shown in the picture below.

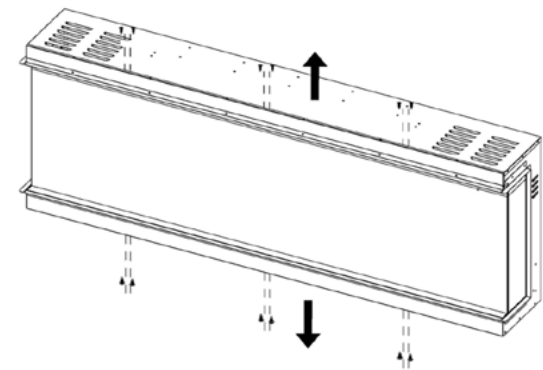

5. Fix the brackets with the screws in the previous step.

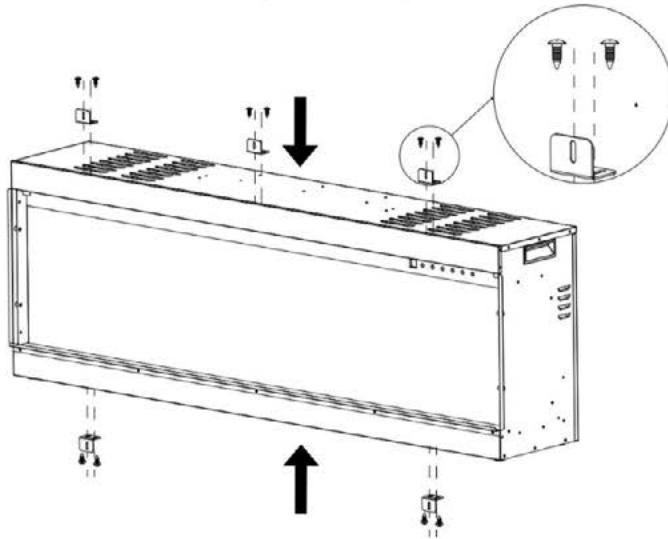

6. Make an opening for the fireplace according to requested measurement.

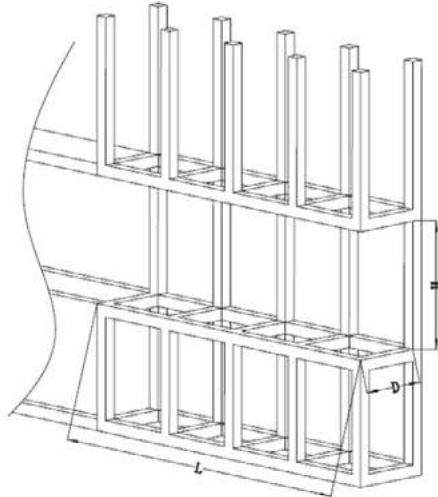

Model Number	L	H	D
BS700PANO	28" 71cm	28.75" 73cm	12.25" 31.2cm
BS1250PANO	48.8" 124cm	21.5" 54.5cm	13.4" 34cm
BS1500PANO	58.8" 149.4cm	21.5" 54.5cm	13.4" 34cm
BS2000PANO-3D	77.6" 197cm	21.5" 54.5cm	13.4" 34cm

7. Insert the fireplace into the wall opening. Drive the mounting screws into the brackets and the wall studs. Plug in and check if the fireplace works properly. If so, move on to next step.

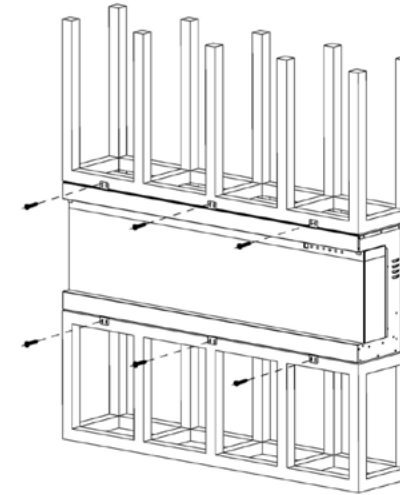

8. Cover the glass panel with protective plastic bag and install plywood or drywall.

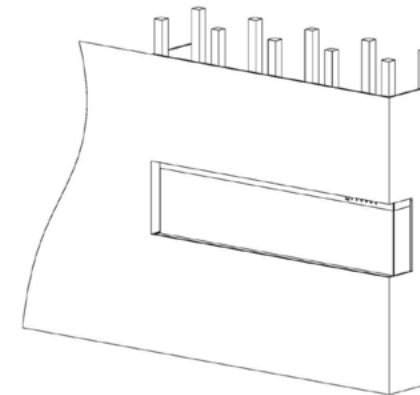

9. Decorate the plywood or drywall with glazed tile, wallpaper, etc.

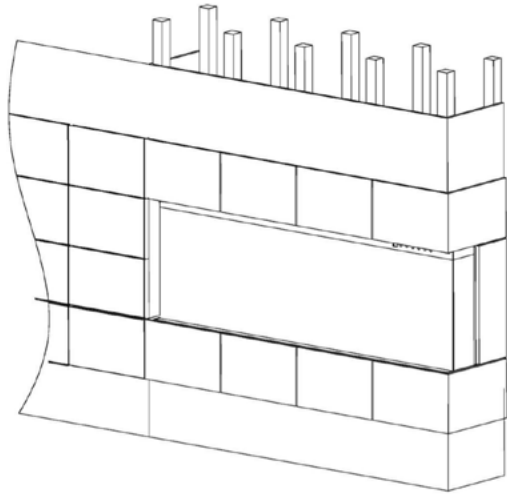

Installation for Front and Left Side Viewing

1. To view the fireplace from front and left side, you need to take off the fending panel on the left side and keep the right side close to a wall.

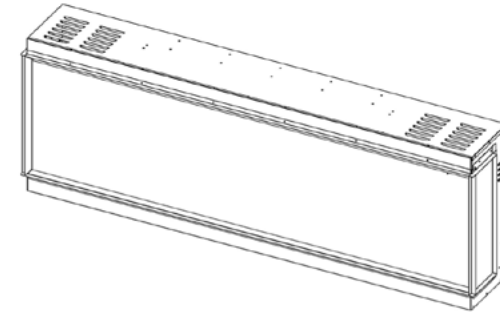

2. Remove the 7 screws on the right side. Take off the fending bar and panel.

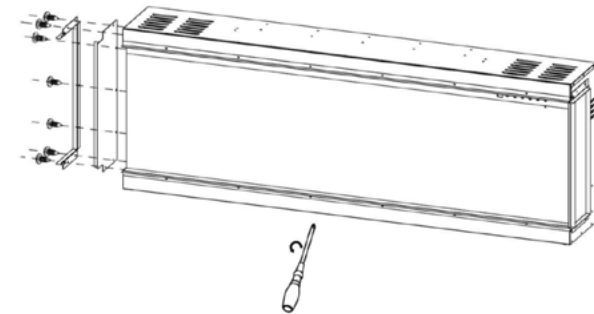

3. Fix back the fending bar after the panel is removed.

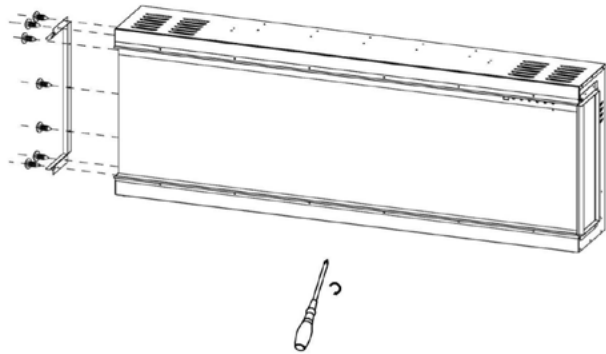

4. Remove the screws from the fireplace as shown in the picture below.

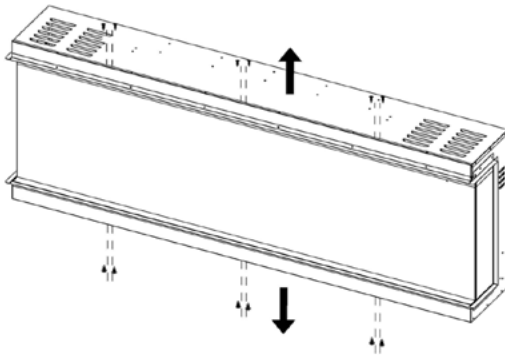

5. Fix the brackets with the screws in the previous step.

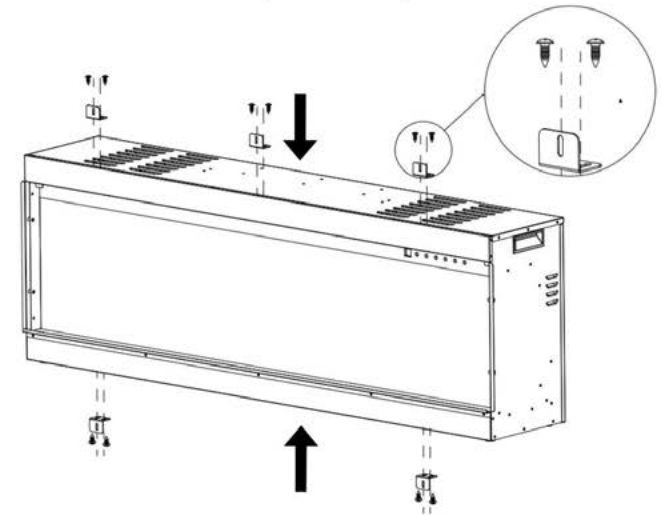

6. Make an opening for the fireplace according to requested measurement.

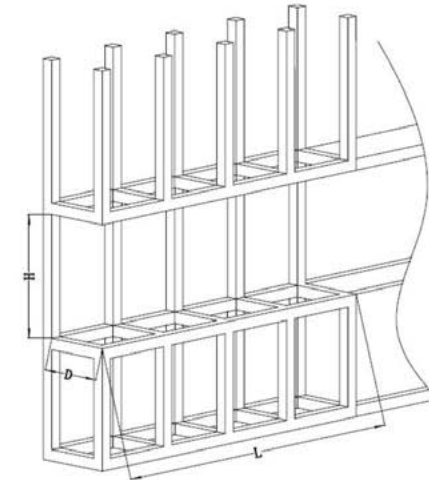

Model Number	L	H	D
BS700PANO	28" 71cm	28.75" 73cm	12.25" 31.2cm
BS1250PANO	48.8" 124cm	21.5" 54.5cm	13.4" 34cm
BS1500PANO	58.8" 149.4cm	21.5" 54.5cm	13.4" 34cm
BS2000PANO-3D	77.6" 197cm	21.5" 54.5cm	13.4" 34cm

7. Insert the fireplace into the wall opening. Drive the mounting screws into the brackets and the wall studs. Plug in and check if the fireplace works properly. If so, move on to next step.

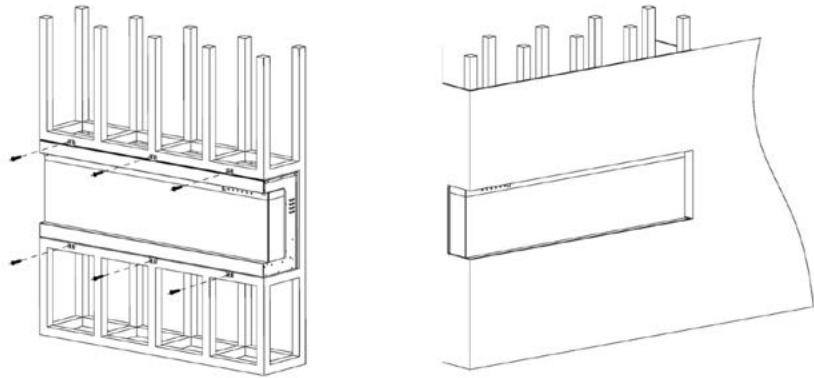

8. Cover the glass panel with protective plastic bag before install plywood or drywall.
9. Decorate the plywood or drywall with glazed tile, wallpaper, etc.

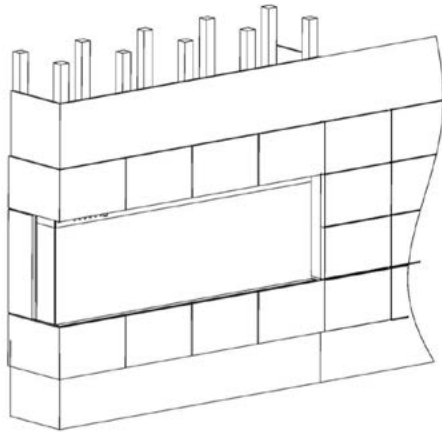

Decorative Crystal & Log Embers Installation

1. Use a screwdriver to take off the 4 screws. (as shown in diagram)

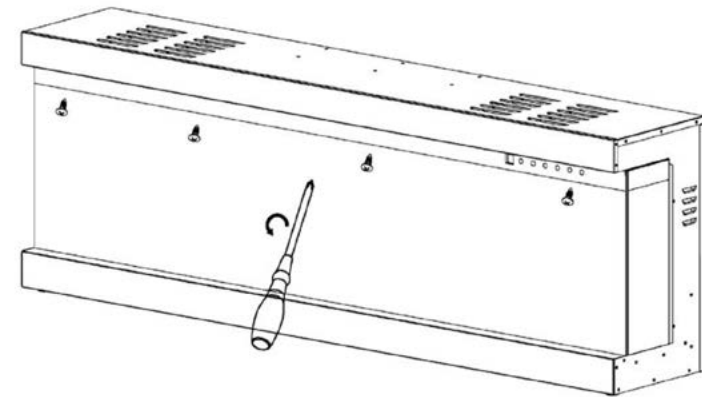

2. Have two people take out the glass panel and move it to a clean soft place to avoid scratching.

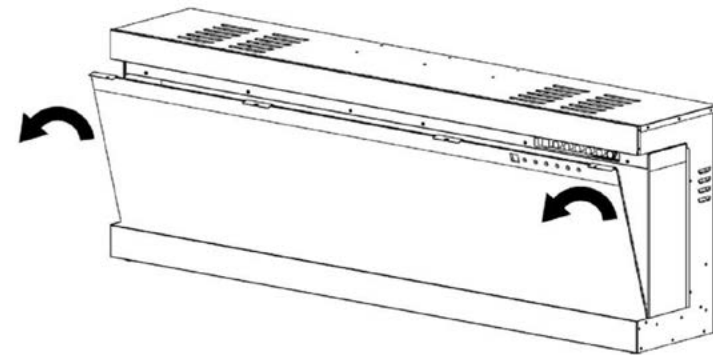

3. Place the decorative crystals/pebbles on the media tray. Apply an even layer from side to side. **Figure 1.**

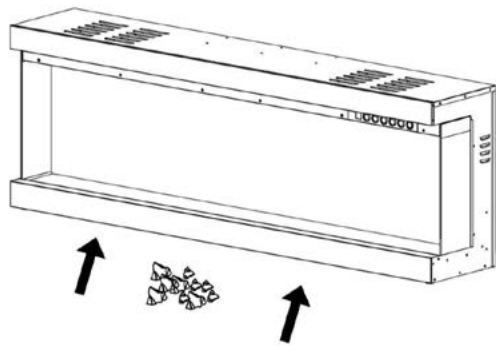

Figure 1.



Figure 2.

4. Put the drift wood logs on the surface of all crystals and put the 4 pieces big crystals between the Gap of each log sets. **Figure 2.**

5. After placing the all decorative media, insert the glass panel back and fasten screws.

Operation



Read and understand this entire owner's manual, including all safety information, before plugging in or using this product. Failure to do so could result in electric shock, fire, serious injury, or death.

Power

Plug the power cord into a 220-240 Volt 10 Amp grounded outlet (see **IMPORTANT SAFETY INFORMATION** on Pages 2 and 3). Make sure the outlet is in good condition and that the plug is not loose. **NEVER** exceed the maximum amperage for the circuit. **DO NOT** plug other appliances into the same circuit.

Methods of Operation

This electric fireplace can be operated by the TOUCH PANEL, located on the upper right side of the fireplace (see below picture), or by the battery-powered REMOTE CONTROL.

Before operating, please review the **IMPORTANT SAFETY INFORMATION** on Pages 2 and 3, and heed all warnings.



Touch Panel

Touch Panel Operation





Touch On Control Panel Operation

BUTTON	FUNCTION	ACTION & INDICATION
POWER	ON: Enables control panel functions and remote control. Turns on flame effect. OFF: Disables control panel functions and remote control. Turns off flame effect.	1. Press once. Indicator light turns on. Power turns on. All functions enabled. 2. Press again. Flame effect turns off. Power and all functions turn off.
FLAME	COLOUR button: Makes the FLAME colors effect changing. NOTE: Colour effect stays on until power button is turned off. Colour flame effect must be on for heater to turn on.	1. Press once. Indicator light turns on. Flame colour effect gets changing. 2. Press again. until desired setting is reached. Display window shows setting.
SPEED	Flame speed button: Makes the flame speed changing. NOTE: Flame speed effect stays on until power button is turned off.	1. Press once. Indicator light turns on. Flame speed effect gets changing. 2. Press again. until desired setting is reached. Cycle from 03-02-01-03-02-01-03 "03" is the default speed.
DOWN LIGHT	LED Down light button (1): Makes the color on TOP effect changing. NOTE: Down light color effect stays on until power button is turned off.	1. Press once. Down light color effect gets changing. 2. Press again. until desired setting is reached. in total 11 colors. "12" Down lights off.
HEATER	HEATER button: Turns heater on and off. NOTE: The heater only works when the flame effect is on. If the flame effect is off, the heater will not turn on. NOTE: To prevent overheating, the heater blows cool air for 10 seconds before the heater turns on, and after it turns off.	1. Press once. The Display shows "H0" and heat is off 2. Press again. Press again. The Display shows "BL" and The cold wind is turned on. 3. Press again. The Display shows "H1" and Low heat is turned on. 4. Press again. The Display shows "H2" and High heat is turned on. Cycle from H0-BL-H1-H2
TIMER	TIMER button: Controls timer settings to turn off fireplace at selected time. Settings range from 0.5 hours to 8 hours.	1. Press once. Indicator light turns on. Timer is set to 0.5 hours. 2. Press again until desired setting is reached. Indicator lights show setting. Cycle from " 00-30-1H-2H-3H-4H-5H-6H-7H-8H







Remote Control Operation



BUTTON	FUNCTION	ACTION & INDICATION
POWER	ON: Enables control panel functions and remote control. Turns on flame effect. OFF: Disables control panel functions and remote control. Turns off flame effect.	1. Press once. Indicator light turns on. Power turns on. All functions enabled. 2. Press again. Flame effect turns off. Power and all functions turn off.
FLAME	COLOUR buttons : Makes the colour flame effect changing. NOTE: Colour effect stays on until power button is turned off. Colour flame effect must be on for heater to turn on.	1. Press blue button to control the blue flame and flame brightness. 2. Press red button to control the orange flame and flame brightness. 3. Press yellow button to control the yellow flame and flame brightness.
SPEED	Flame speed button: Makes the flame speed changing. NOTE: Flame speed effect stays on until power button is turned off.	1. Press once. Indicator light turns on. Flame speed effect gets changing. 2. Press again. until desired setting is reached. Cycle from 03-02-01-03-02-01 "03" is the default speed
DOWN LIGHT	LED Down light button (1): Makes the color on TOP effect changing. NOTE: Down light color effect stays on until power button is turned off.	1. Press once. Down light color effect gets changing. 2. Press again. until desired setting is reached. Cycle from 01-02-03-04-05-06-07-08-09-10-11-12-01 "12" Down lights off
HEATER	HEATER button: Turns heater on and off. NOTE: The heater only works when the flame effect is on. If the flame effect is off, the heater will not turn on. NOTE: To prevent overheating, the heater blows cool air for 10 seconds before the heater turns on, and after it turns off.	1. Press once. The Display shows "H0" and heat is off 2. Press again. Press again. The Display shows "BL" and The cold wind is turned on. 3. Press again. The Display shows "H1" and Low heat is turned on. 4. Press again. The Display shows "H2" and High heat is turned on. Cycle from H0-BL-H1-H2

	LED Ember light button (1): Makes the color on bottom effect changing. NOTE: Ember color effect stays on until power button is turned off.	1. Press once. Ember color effect gets changing. 2. Press again. until desired setting is reached.
	LED Ember light button (2): Makes the brightness on bottom effect changing	1. Press once. Ember color brightness effect gets changing. 2. Press again. until desired setting is reached

TIMER SETTINGS ON REMOTE CONTROL





	Timer: Displays current day, time, and week. Press to enter or confirm timer settings.	
OK	Settings: Press to move to next step (use with Timer button). Press to confirm week timer.	
	Back: Press to clear timer settings. Press to return to the previous step (use with Settings button).	
	Up and Down (use with Settings button).	
LCD Screen		
Weekday Mon, Tues, Wed, Thurs, Fri, Sat, Sun		Note: The functions can only be adjusted when the related letters or digits are flashing. Note: Calibrate the timer to current time before the weekly settings.
Time Display		
Current Time / Timer From 00:00 to 24:00 NOTE: 00-12:00 is AM / 13:00-24:00 is PM		

	TEMPERATURE button: Turns heater on and off. NOTE: Press & Hold the button for 5 seconds, the temperature setting will switch from °C to °F. Same way from °F to °C.	1. Press once: Indicator lights up. Temperature goes to 18 °C 2. Press again: until desired setting is reached. Digital display shows setting circles as below:																																										
TEMP	<table border="1"> <tr> <td>NO</td> <td>0</td><td>1</td><td>2</td><td>3</td><td>4</td><td>5</td><td>6</td><td>7</td><td>8</td><td>9</td><td>10</td><td>11</td><td>12</td> </tr> <tr> <td>°C</td> <td>18</td><td>19</td><td>20</td><td>21</td><td>22</td><td>23</td><td>24</td><td>25</td><td>26</td><td>27</td><td>28</td><td>29</td><td>30</td> </tr> <tr> <td>°F</td> <td>64</td><td>66</td><td>68</td><td>70</td><td>72</td><td>74</td><td>76</td><td>78</td><td>80</td><td>82</td><td>84</td><td>86</td><td>88</td> </tr> </table>	NO	0	1	2	3	4	5	6	7	8	9	10	11	12	°C	18	19	20	21	22	23	24	25	26	27	28	29	30	°F	64	66	68	70	72	74	76	78	80	82	84	86	88	
NO	0	1	2	3	4	5	6	7	8	9	10	11	12																															
°C	18	19	20	21	22	23	24	25	26	27	28	29	30																															
°F	64	66	68	70	72	74	76	78	80	82	84	86	88																															

NOTICE When the heater is first turned on, a slight odour may be present. This is normal and should not occur again unless the heater is not used for a long period of time.

NOTICE To improve operation, aim the remote control at the front of the fireplace. **DO NOT press the buttons too quickly.** Give the unit time to respond to each command.





1 Set current day and time

- Press  once. When "MON" (Monday) begins flashing, use  to selected current day. Press **OK** to complete the setting.
- When the hour digits begin flashing, use  to select the current hour. Press **OK** to complete the setting.
- When the minute digits begin flashing, use  to select the current minute. Press **OK** to complete the setting.



2 Set ON/OFF time and temperature on a weekly cycle

- Press  once. When "MON" (Monday) begins flashing, use  to selected current day. Press **OK** to complete the setting.

note:
The timer can only be adjusted in 30-minute intervals (i.e. 00:00 - 00:30; 00:30 - 01:00, etc.)

- When  begins flashing, use  to select the desired hour and minutes to turn on the heater. Press **OK** to complete the setting. Press  at any time to clear the digits and shut down "ON" timer.
- When "18" begins flashing, use  to selected the desired temperature to turn on the heater for Monday.

note:
If the temperature was previously set, those digits will be shown instead of "18".

- When  begins flashing, use  to select the desired hour and minutes to turn off the heater. Press **OK** to complete the setting. Press  at any time to clear the digits and shut down "OFF" timer.
- Repeat steps 1 to 4 to set the "ON/OFF" time and temperature for Tuesday, Wednesday, Thursday, Friday, Saturday, and Sunday.
- Press **OK** to complete programming, ensuring to aim the remote control at the receiver, located in the middle of the appliance. The appliance will "beep" once to confirm that programming has been successful.

Open window warning

If the room temperature decreases by 10 degrees within 3 minutes, the appliance will assume there is an open window nearby. In order to conserve energy, the heater will automatically switch from High Heat to Low Heat, or if the heater is already at Low Heat, it will turn off completely.

When switching from High Heat to Low Heat, the appliance will beep 3 times and the digital display will flash "88" 3 times before displaying the existing heating status.

When switching from Low Heat to Off, the appliance will beep 3 times and the digital display will flash "88" continuously.

To reset the heating function, see "operating remote control" section.

Temperature Limiting Control

This heater is equipped with a Temperature Limiting Control. Should the heater reach an unsafe temperature, the heater will automatically turn OFF. To reset:

1. With the POWER switch in the OFF position, unplug the power cord from the outlet.
2. Turn the ON/OFF switch on the CONTROL PANEL to OFF. **Wait 5 minutes.**
3. Inspect the fireplace to make sure no vents are blocked, or clogged with dust or lint. If they are, use a vacuum to clean the vent areas.
4. With the POWER switch in the OFF position, plug the power cord back into the outlet.
5. If the problem continues, have your outlet and wiring inspected by a professional.

Remote Control Battery Information

- This remote control uses **Two AAA batteries (NOT included).**



NEVER dispose of batteries in **fire**. Failure to observe this precaution **may result in an explosion**. Dispose of batteries at your local hazardous material processing center.

Care and Maintenance

Cleaning



ALWAYS turn the fireplace **OFF** and **unplug the power cord from the outlet** before cleaning, performing maintenance, or moving this fireplace. Failure to do so could result in **electric shock, fire, or personal injury**.



NEVER immerse in water or **spray with water**. Doing so could result in **electric shock, fire, or personal injury**.

Metal:

- ^ Buff using a soft cloth, slightly dampened with a citrus oil-based product.
- ^ **DO NOT** use brass polish or household cleaners as these products will damage the metal trim.

Glass:

- Use a good quality glass cleaner sprayed onto the cloth or towel. Dry thoroughly with a paper towel or lint-free cloth.
- **NEVER** use abrasive cleansers, liquid sprays, or any cleaner that could scratch the surface.

Vents:

- Use a vacuum or duster to remove dust and dirt from the fireplace and vent areas.

Plastic:

- Wipe gently with a slightly damp cloth and a mild solution of dish soap and warm water.
- **NEVER** use abrasive cleansers, liquid sprays, or any cleaner that could scratch the surface.

Maintenance



Risk of electric shock! DO NOT OPEN any panels ! No user-serviceable parts inside!



ALWAYS turn the fireplace **OFF** and **unplug the power cord from the outlet** before cleaning, performing maintenance, or moving this fireplace. Failure to do so could result in **electric shock, fire, or personal injury**.

Electrical and Moving Parts:

- The fan motors are lubricated at the factory and will not require lubrication.
- Electrical components are integrated in the fireplace and are not serviceable by the consumer.

Storage:

- Store fireplace in a clean dry place when not in use.



WARNING! NO SERVICING of the internal or electrical parts should be performed by the consumer. **DO NOT** service the unit yourself.

⚠ WARNING

**DISCONNECTED THE APPLIANCE COMPLETELY AND LET COOL PRIOR TO ANY SERVICE.
ONLY A QUALIFIED SERVICE PERSON SHOULD SERVICE AND REPAIR THIS ELECTRIC APPLIANCE.**

Problem	Possible Cause	Solution
1. Fireplace turns off and will not turn on.	1. Fireplace has overheated and safety device has caused thermal switch to disconnect or home circuit breaker has opened.	1. Reset switch by turning main power switch off and waiting 10 minutes then turning it back on or reset circuit breaker.
2. Flame is not moving.	1. Loose wiring. 2. Flame motor defective. 3. Flame rod out of place	1. Inspect wiring for loose connections. 2. Call a qualified service technician to replace flame motor. 3. "Flame Rod" out of place due to rough transit/handling of the product. This issue can be corrected as simple as removing the glass, flipping the fireplace upside down, removing a set of screws that are holding the bottom frame plate and placing the flame rod back into place.
3. Flame is not visible.	1. Wiring is loose.	1. Disconnect from power source and inspect wiring for loose connections and repair or replace if necessary. 2. Push the flame button to high
4. Log set and/or is not glowing.	1. Wiring is loose. 2. Ember is in off mode	1. Disconnect from power source and inspect wiring for loose connections and repair or replace if necessary. 2. Push the ember button is high
5. Remote control does not work.	1. Low batteries. 2. Not aiming control correctly. 3. Defective remote control and/or sensor.	1. Replace batteries in remote control. 2. Aim control at sensor located directly behind glass screen in center of unit just above logs. 3. Replace remote control and/or sensor.
6. Fireplace will not come on when switch is flipped to ON.	1. Fireplace is not plugged in to an electrical outlet. 2. Control failure. 3. Breaker tripped.	1. Check plug. 2. Call a qualified service technician. 3. Reset breaker.

7. Heater does not provide heat when turned on.	1. Thermal switch has been tripped. 2. Wiring is loose. 3. Heater is defective.	1. Turn unit off and unplug unit for 10 minutes. Plug back in and turn unit on. If plug cannot be reached, follow directions for tripped circuit breaker. 2. Disconnect from power source and inspect wiring for loose connections and repair or replace if necessary. 3. Replace heater.
8. Touch panel / Remote Control do not work	The front glass is moved or not secured properly.	Unplug the appliance, if the appliance is recessed to the wall, shut off house circuit breaker. Ensure the front glass is in the correct location and is sitting flat to the appliance touch panel. after 15 seconds, plug or turn on the appliance to reset it.

CAUTION: To remove the glass, you will notice two screws on front both sides (right and left) of the fireplace. Once the screws are removed, slide the glass up and away from the fireplace. Once the bottom frame plate is removed, you will notice one flame motor on right side where the rod should be in place with the rubber plugs.

Please remember to always have the unit disconnected prior to any work, always lay glass as well as the unit on a towel or other material not to damage parts/frame.

This entire process should not take longer than 20-30 minutes.



www.bespokefireplace.co.uk